



For Android™ 7.1.2

# Enterprise Mobility

# PM550

# User Manual

# User Manual

Please note your phone is battery-embedded design with removable battery and battery cover. Unauthorized personnel are strictly prohibited from disassembling the phone. Make sure to use only the power adapter (5V 2A Output AC/DC) that came with PM550.

In case your phone does not work as expected, you are strongly recommended to restart it by pressing and holding the power button for at least 12 seconds until the startup screen appears. If your phone has encountered a serious error and cannot be recovered, you should reset your phone to factory settings by using the menu, either “Backup & Reset”, or “Factory Reset”. For more details, please refer to “Factory data reset” section on page 51

**Note:** Please be cautious while performing the factory data reset. Because this will erase personalized settings and data saved in your phone, such as SMS, Contacts, Music, etc.



[www.sar-tick.com](http://www.sar-tick.com)

## Body-worn Operation

This device was tested for typical body-worn operations with the front & back of the phone kept 0.2 inches (0.5 cm) between the user's body and the front & back of the phone. A minimum separation distance of 0.2 inches (0.5 cm) must be maintained between the user's body and the front & back of the phone. Any belt clips, holsters, and similar accessories containing metallic components may not be used. Body-worn accessories that cannot maintain 0.2 inches (0.5 cm) separation distance between the user's body and the front & back of the phone, and have not been tested for typical body-worn operations should be avoided.



## PROTECT YOUR HEARING

To prevent possible hearing damage, do not listen at high volume levels for long periods. Exercise caution when holding your device near your ear while the loudspeaker is in use.

Rev 03

# Table of Contents

User Manual.....	1
Table of Contents.....	2
Getting Started.....	3
Major Parts.....	3
Accessory.....	5
Charge PM550.....	6
Turn On/Off PM550.....	8
Hot swap the battery.....	9
Learning the basics.....	10
Use a keypad.....	10
Use a touch screen.....	12
Setup Wizard.....	14
Home Screen, Apps and Widget.....	21
Status & Notifications Icons.....	30
Connect to your Wi-Fi network.....	31
Scanner Settings.....	33
Use a Scanner.....	33
Scan a Barcode.....	42
OS Update.....	44
OS Image update from Storage.....	44
OS Image update from OTG Port.....	46
OS Image update from the FOTA.....	49
Factory data reset.....	51
Factory data reset from Settings.....	51
Force Factory data reset.....	53
EmKit.....	56
EmKit Secure.....	57
EmKit Remote.....	60
EmKit Tools.....	68
EmKit Demos.....	77

# Major Parts

## Getting Started

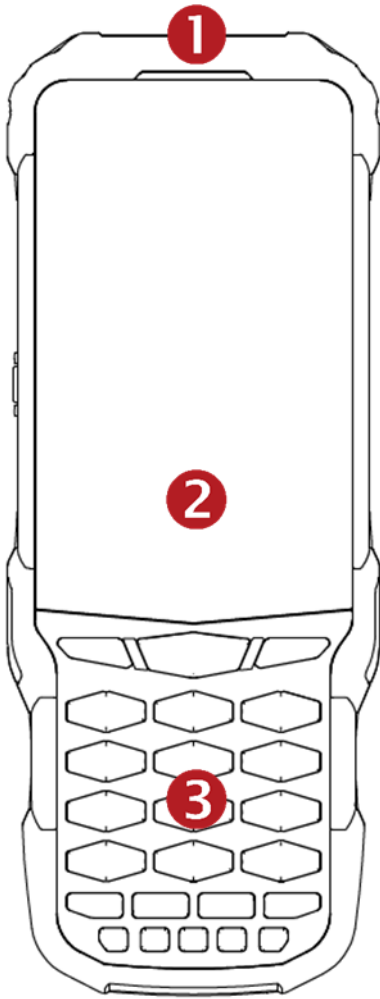

1. LED Indicator

2. Touch Screen

3. Key pad

## Major Parts

## Getting Started

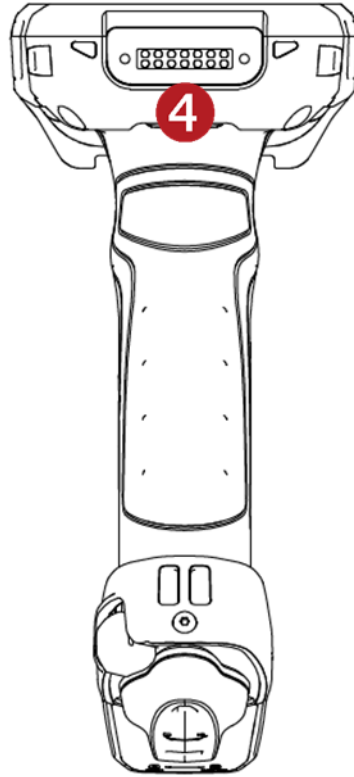
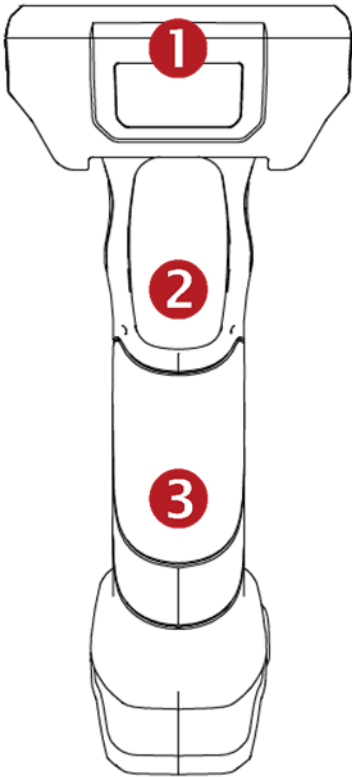

1. Scanner
2. Scanner trigger
3. Gun handle
4. Charging pad
5. Power key
6. USB-C type connector
7. Battery lock

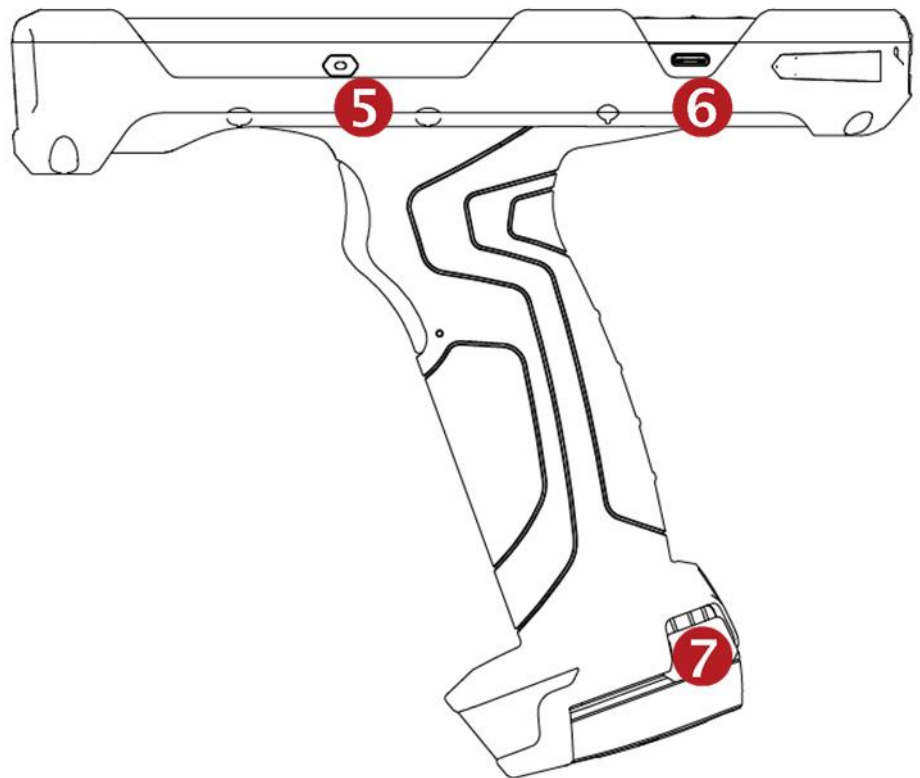

## Accessory

## Getting Started

AC/DC adapter



Plug (US/ EU/ UK)



USB Type-C cable



Li-ion battery (6300mAh)



## Charge PM550

### Getting Started

1. Insert "Battery" into the Gun handle. Press the Battery lock and turn the Battery to "Lock" position (Clockwise)

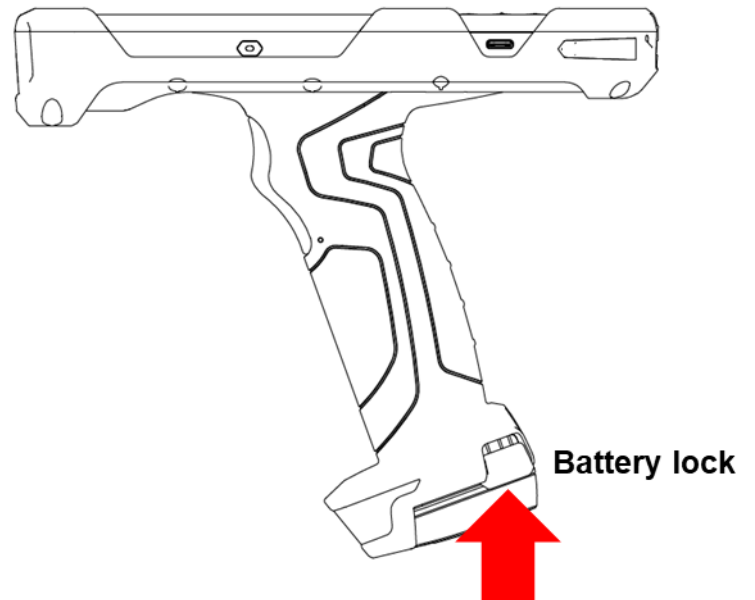
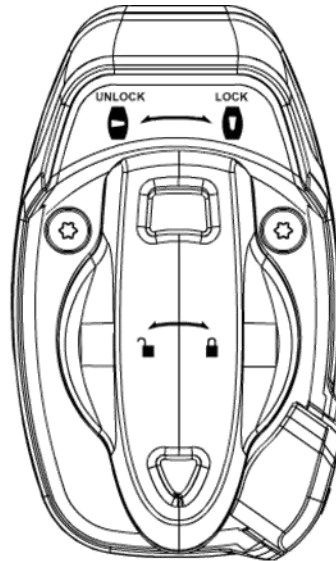
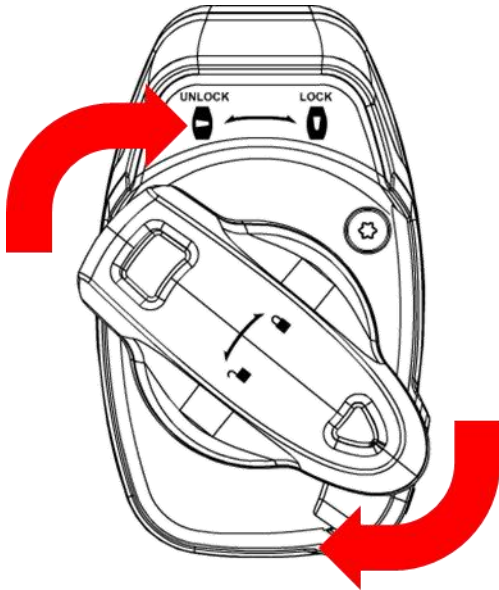

## Charge PM550

## Getting Started

2. Connect the AC/DC adaptor to your device and wall socket respectively

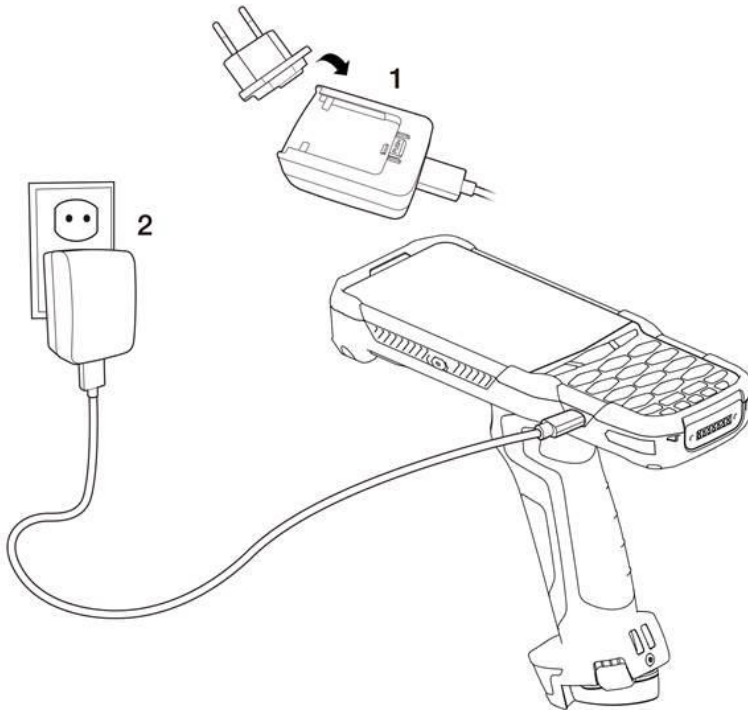

3. LED indicator will display charging status.

Steady Red	Battery is charging
Blinking Red	Battery level is critical low
Steady Green	Battery is fully charged

### PM550 Battery Specification

Main Battery	6,300mAh / 3.63V
Backup Battery	60mAh / 3.7V
Charging time	About 6.5 hours

**Note:** Always use an original charger and cable from the Point Mobile. Other chargers and cables may damage PM550. In addition, make sure connector, charger, cables are not wet.



# Turn On/Off PM550

## Getting Started

### Turn On

1. Press and hold the “Power Key” for a few seconds.
2. When PM550 enter to the boot mode, it will display “SMART BEYOND RUGGED” logo with short vibration
3. Release the “Power Key” and wait until PM550 finish booting

**Note:** If you cannot turn on your PM550, try below steps

- To turn on PM550, battery needs to be charged certain level. Please charge first
- Press and hold the “Power key” for 12 seconds to force reboot
- Press and release the “Reset Hole” and then turn on PM550 again (Check)

### Turn Off

1. Press and hold the “Power Key” until you see the power menu

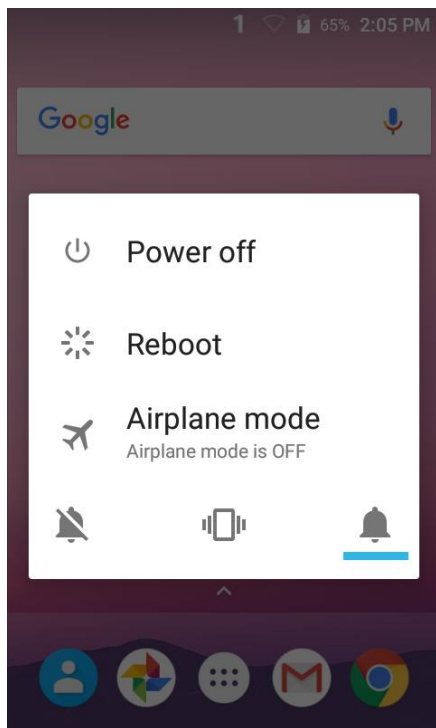

2. Among the menu, tap “Power Off”

## Hot swap the battery

### Getting Started

When battery level is low, you can replace the battery without turning off and on PM550.

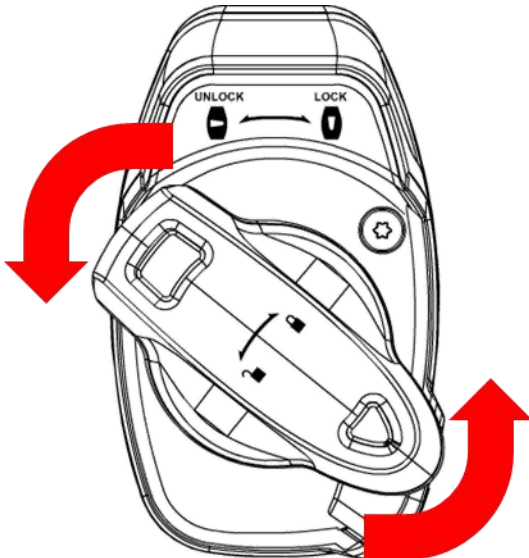
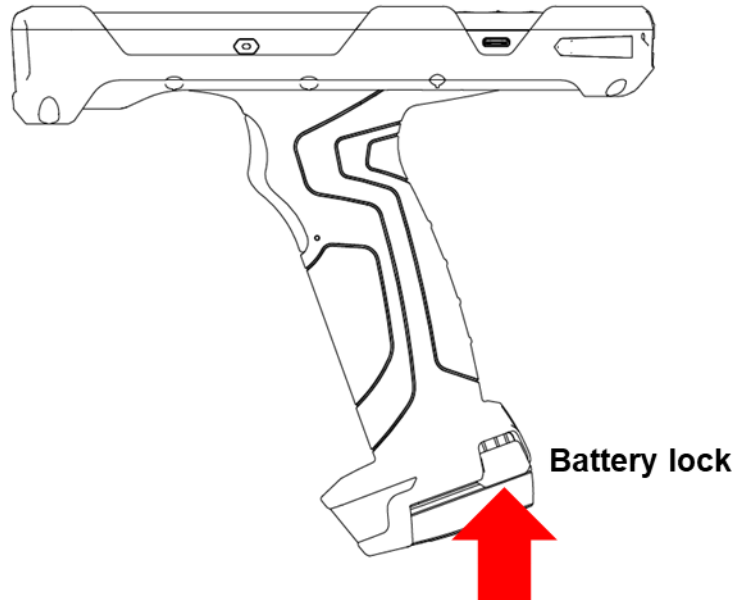
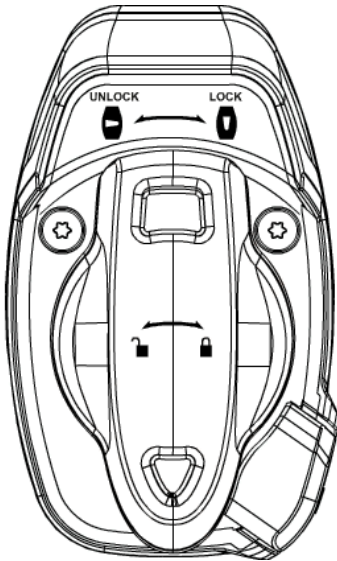

- Remove the Battery and replace to another one.
- Make sure the battery is locked properly.
- Press the Power Key to use PM550 again.

## Use a keypad

### Learning the basics

#### Power key



Press

- Lock the screen / Light up the screen.

Press and hold

- Display the power menu “Power Off / Reboot / Airplane mode”

Press and hold for 12seconds

- Forced to reboot

Press the “Power” key and “Home Button” key together

- Screen capture

#### Scanner trigger

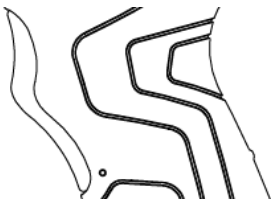

When “Scan Setting” is turned on

- By pressing, PM550 scan the barcode.

# Using a keypad

## Learning the basics

### Numeric Keypad



#### Recent Apps key

- Press to see recently used apps.

#### Home key

- From any apps or screens, press to return to the Home screen.

#### Back key

- Press to go back to the previous screen, or to close a dialog box, options menu, notification panel, etc.

#### Numeric key

- Press to type numbers in the keypad



#### Yellow Key combination

- Press to type alphabet or special character



#### Blue Key combination

- Press to type function key (Blue color)



---

## Use a touch screen

---

### Learning the basics

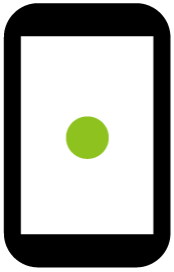

#### Touch

One-finger press

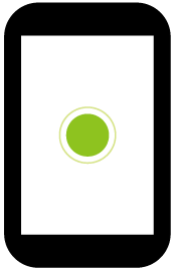

#### Double touch

One-finger press, lift, one-finger press, lift for “Zoom in”



#### Long press

One-finger press, wait, lift for “Select an item”

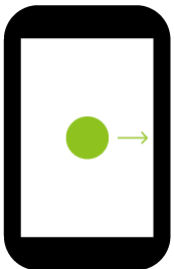

#### Drag, Swipe, or Fling

One-finger press, move, lift for “Scroll” or “Tilt”

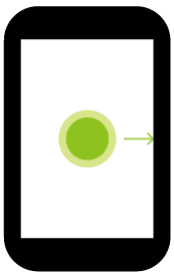

#### Long-press drag

One-finger press, wait, move, lift for “Pick up and move” or “select multiple items”

---

## Use a touch screen

### Learning the basics

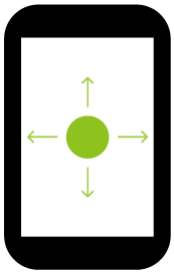

#### Scroll

Vertical or horizontal swipe in a single direction

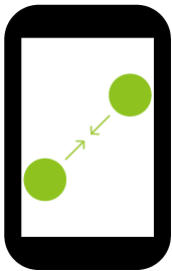
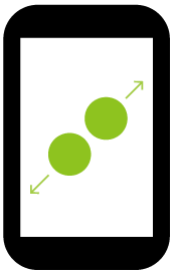

#### Pinch Open & Close

Two-finger press, move outwards and inwards, lift for “Zoom in and out”

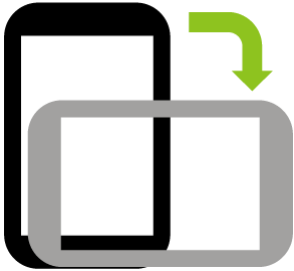

#### Rotate

When PM550 is turning sideways, screen orientation is changing

# Setup Wizard

## Learning the basics

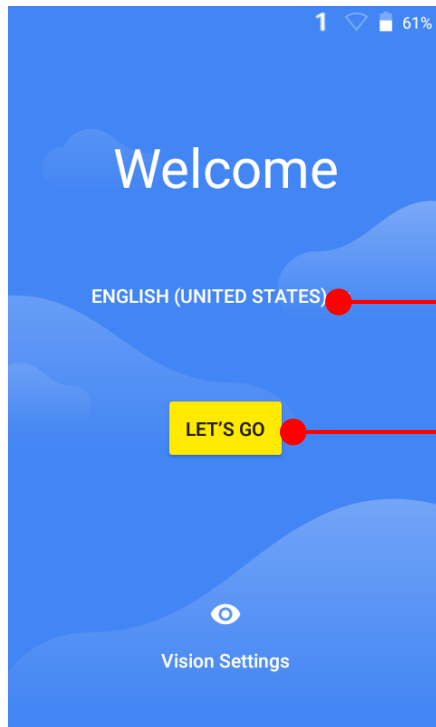

When you power on your device very first time or boot after factory reset, you need to setup your device

### Language Selection

- Choose your language during setup process. Default is English

Touch here to start setup your device

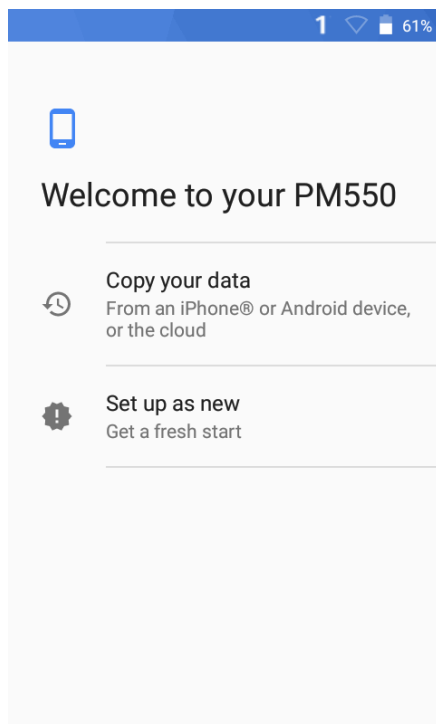

You can copy other device's settings to your PM550 or setup as a new device

### Copy your data

- You can copy your settings from other Android phone or Google account or iPhone

### Set up as new

- Set your PM550 as your new device

# Setup Wizard

## Learning the basics

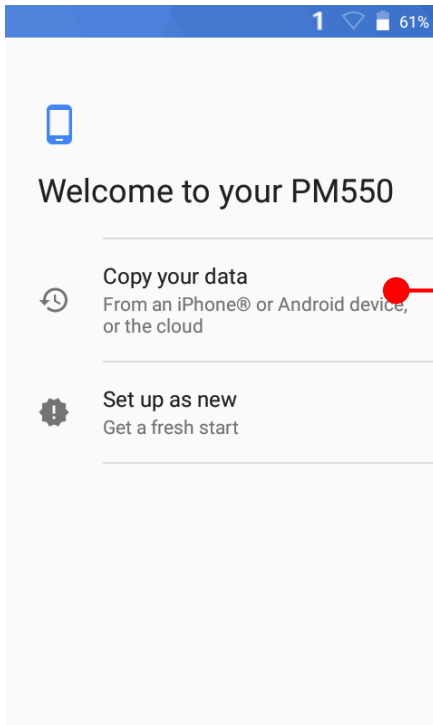

### Copy your data process

- Touch here to copy settings from your other devices

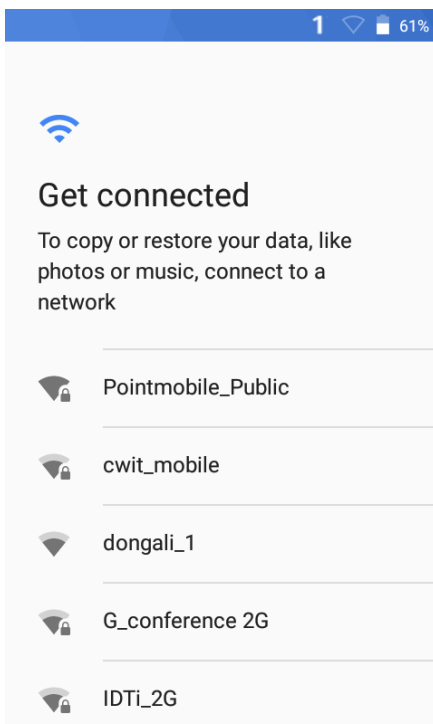

To copy your settings, please connect your PM550 to Wi-Fi network



# Setup Wizard

## Learning the basics

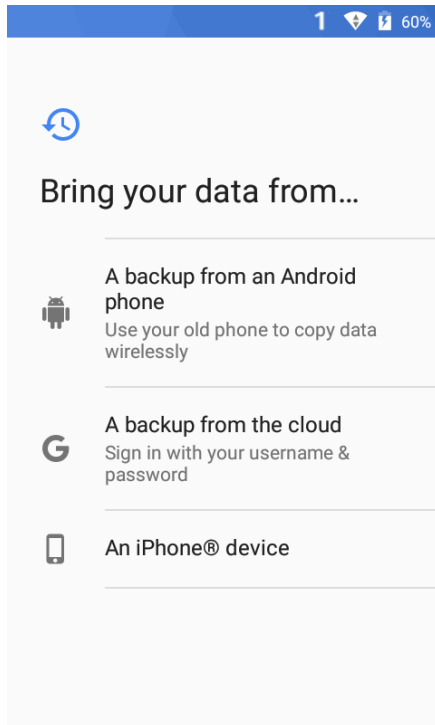

Choose the device or cloud where you want to copy the settings.

# Setup Wizard

## Learning the basics

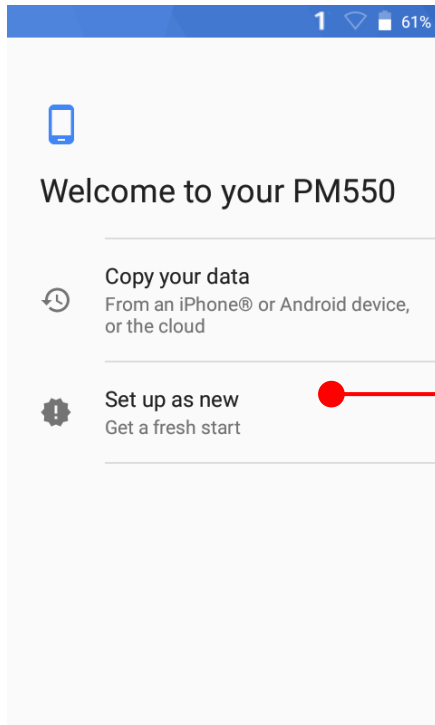

### Setup as new

- Touch here to set your PM550 as your new device

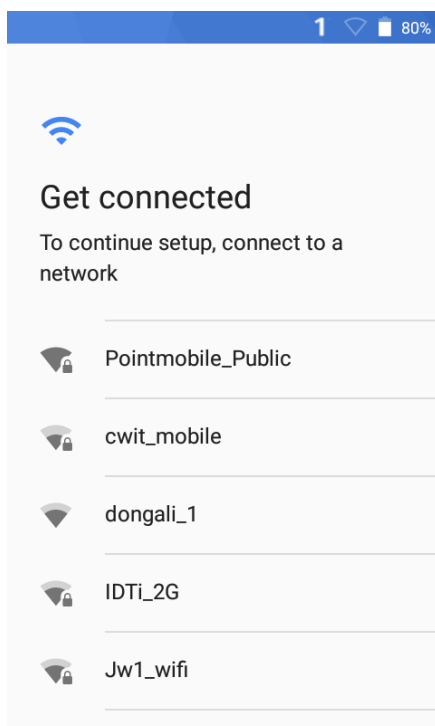

During setup process, Google services setup required.  
Please connect your device to your Wi-Fi network.

# Setup Wizard

## Learning the basics

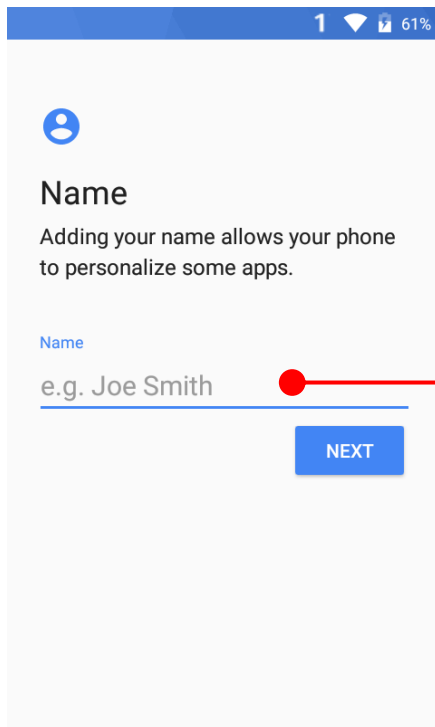

After your Google account login, you can set PM550's name. Touch here to set a name

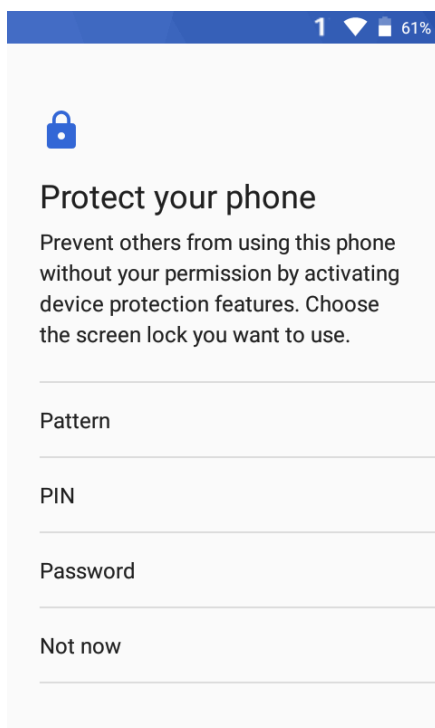

Choose security option for lock screen. You set specific pattern or PIN or password here.

# Setup Wizard

## Learning the basics



### Google services

Tap to learn more about each service, such as how to turn it on or off later. Data will be used according to Google's [Privacy Policy](#).

#### Location

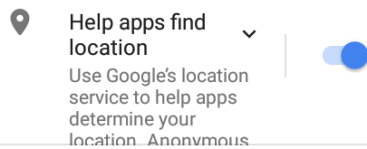

**MORE**

To review the Google services option, please touch **MORE** button. You can turn On/Off specific service



you can manage it in My Activity.

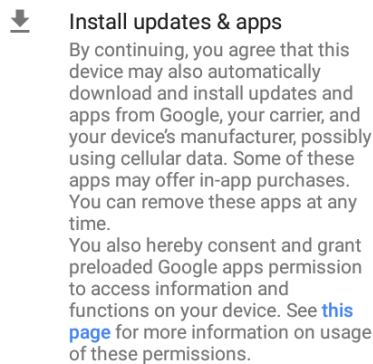

If you continue, you also agree to the [Google Terms of Service](#).

**AGREE**

After your reviewing and set Google services option, touch **AGREE** button for next step

# Setup Wizard

## Learning the basics

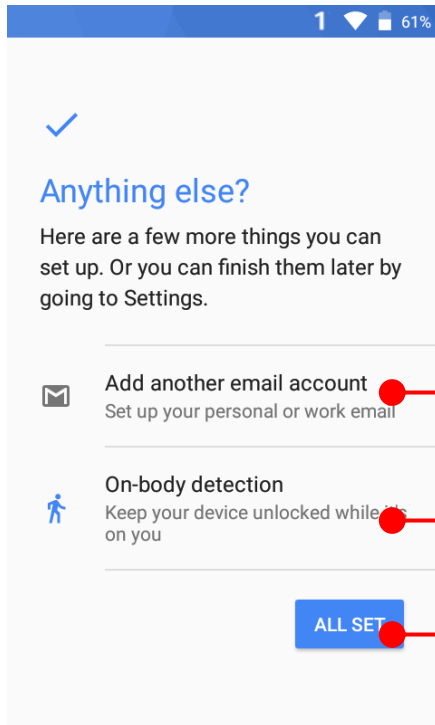

Touch to setup another e-mail account

Touch to use Smart Lock On-body detection

If you set up is done, touch ALL SET extra Touch an icon to run an app, open folder, etc

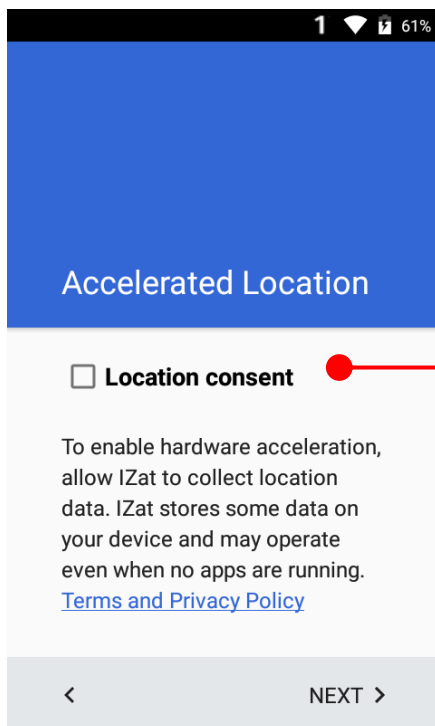

PM550's default setting is **High accuracy** mode which use GPS, WLAN for accurate location tracking. If you want to enable hardware acceleration as well, please check **Location consent**

# Home Screen, Apps and Widget

Learning the basics

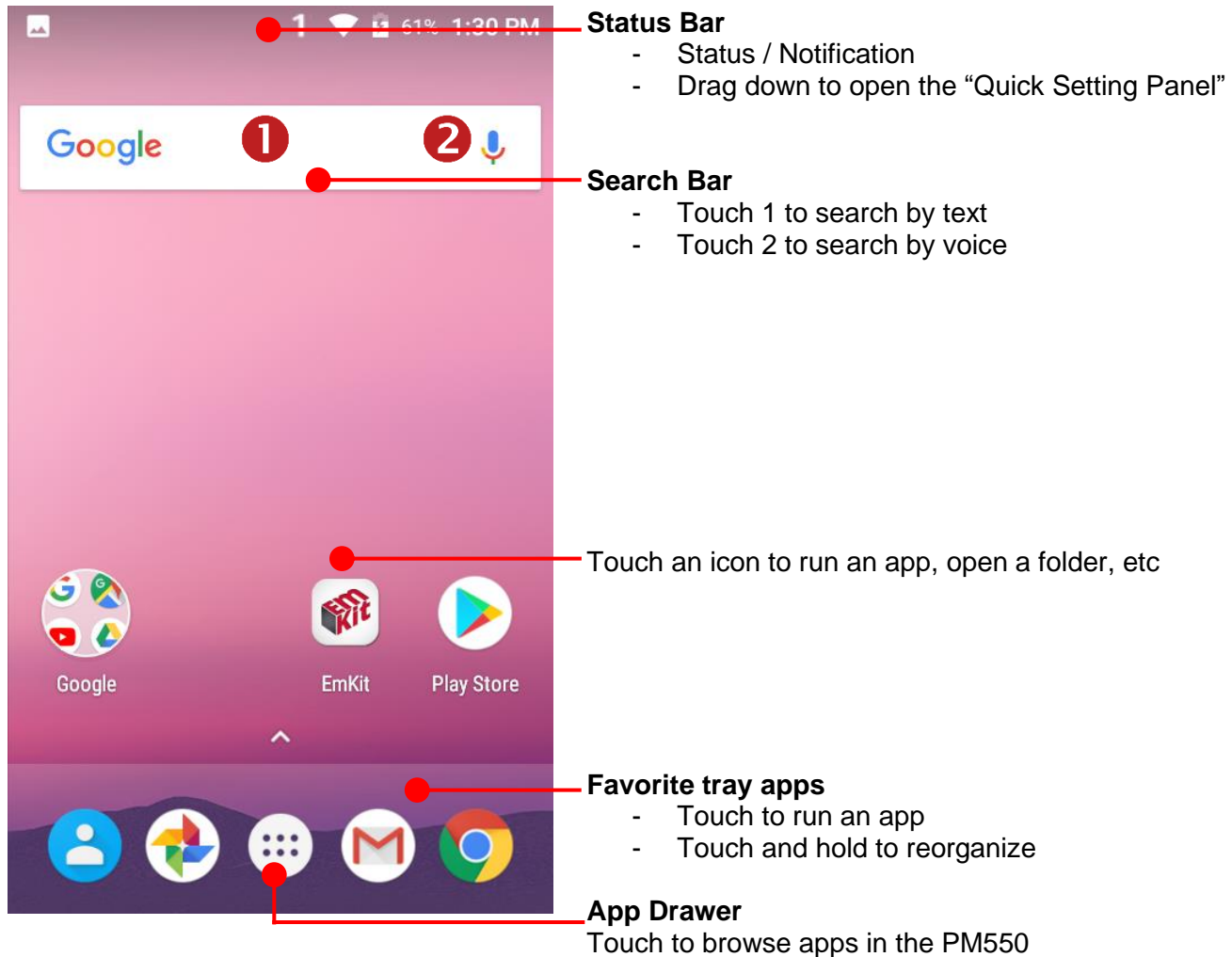

# Home Screen, Apps and Widget

Learning the basics

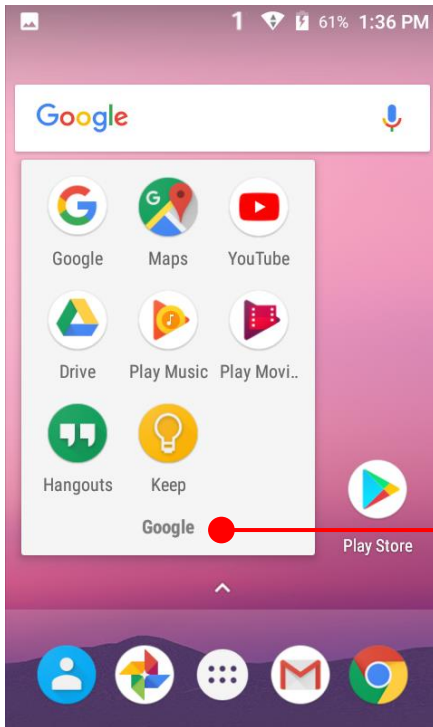

## To access app folder

- Touch the app folder then you will see apps in the folder.
- To change app folder's name, touch the bottom area of the folder.

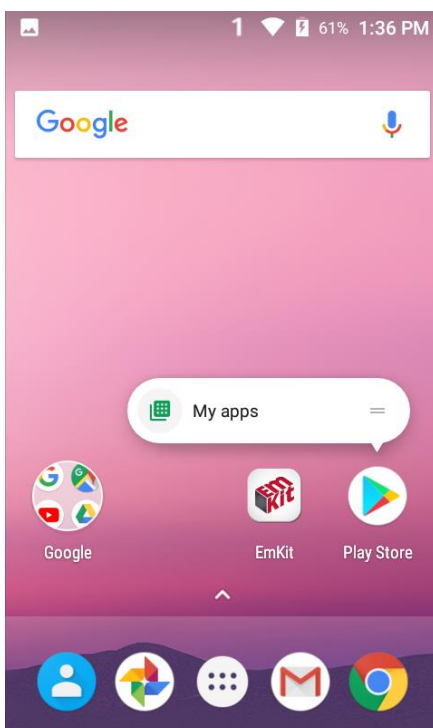

## To see App's option for quick access

- Long press the app icon. Then you will see options from the app. Here option may differ by app

# Home Screen, Apps and Widget

## Learning the basics

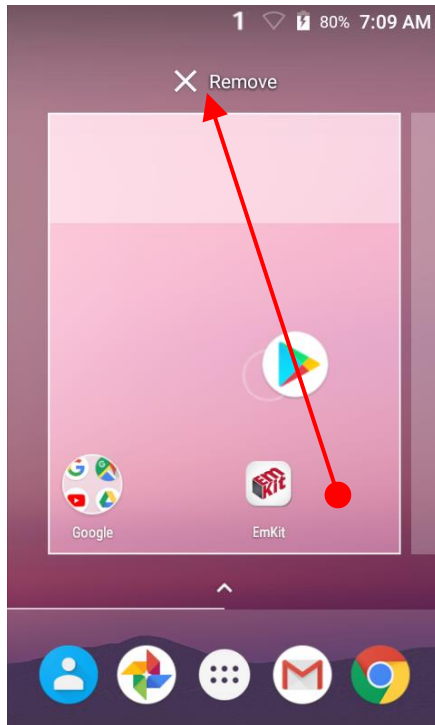

### Organize the app icon in the home screen

- Long-press drag the app icon and place where you want. You may place app icon to next panel
- If you want to remove the app icon, drag it to "Remove" area and release

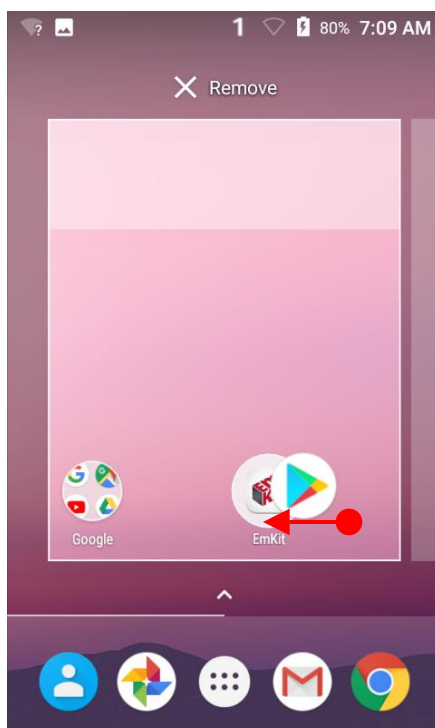

### Create "App Folder"

- Long press the app icon to other app icon. This will create the "App Folder"
- To set the folder name, touch the "Unnamed Folder" and rename it



# Home Screen, Apps and Widget

## Learning the basics

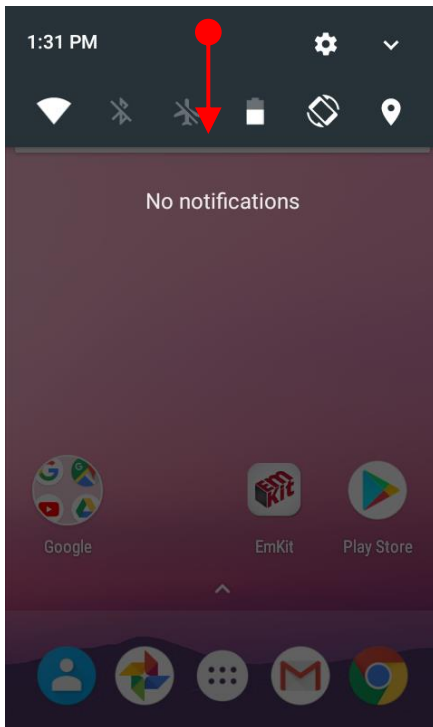

### Notification panel

When there is notification from the Android (system) or the App, you can check details by drag down the "Status Bar".

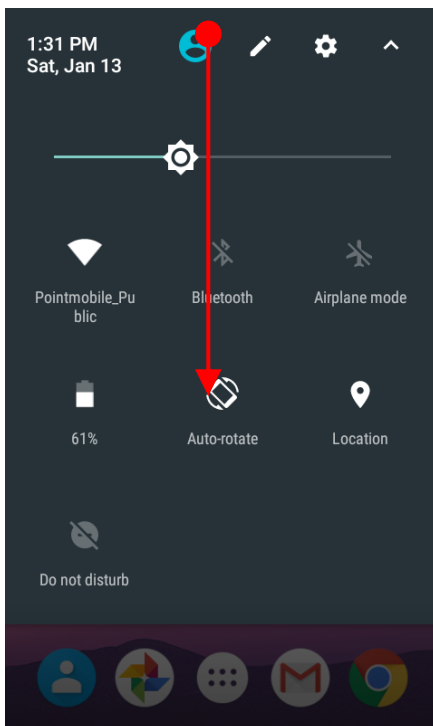

### Quick setting panel

You can access "Quick setting panel" by drag down the "Notification panel". You can enable / disable functions or change modes easily.

# Home Screen, Apps and Widget

Learning the basics

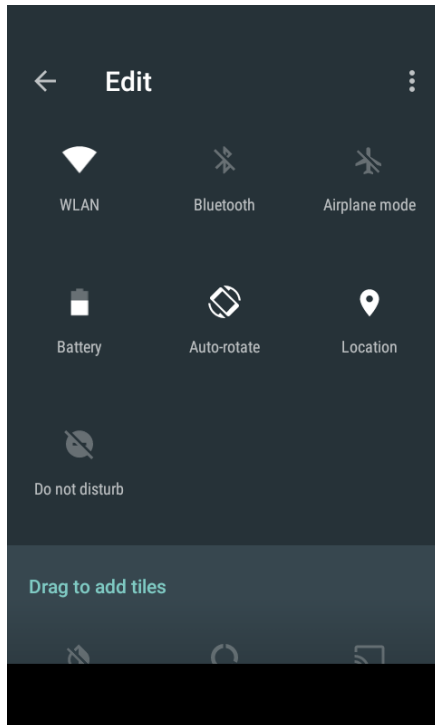

## Edit Quick settings panel

To change the order of icon in the Quick settings panel, touch the  Edit icon

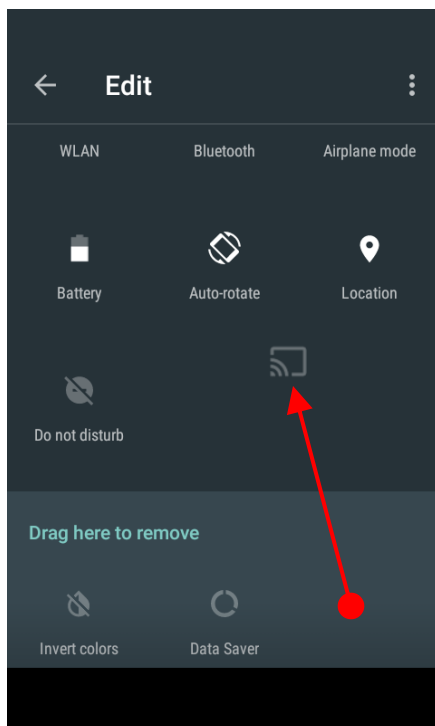

By dragging the icon, you can customize the Quick settings panel

# Home Screen, Apps and Widget

## Learning the basics

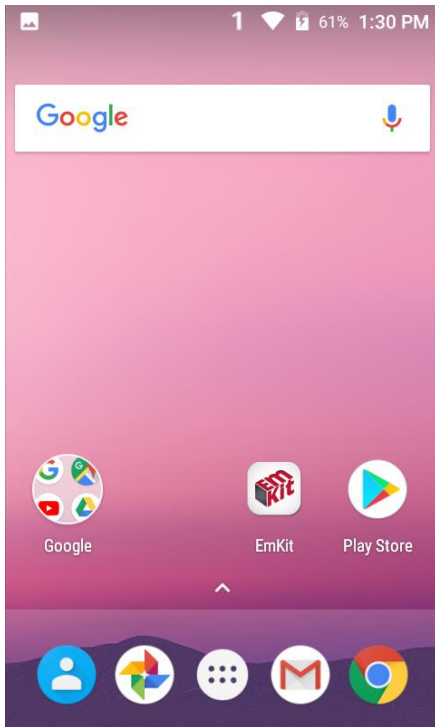

Touch the  App drawer icon, to see apps in your PM550

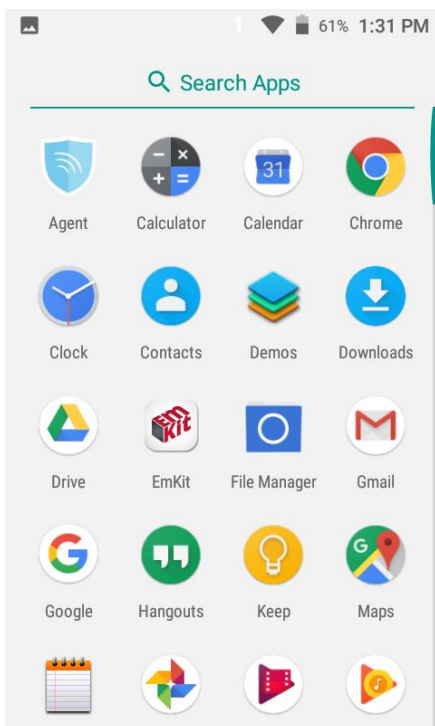

All installed apps are listed alphabetically

- Tap app icon to run.
- Long press, specific app icon to place to the “Home Screen”.

# Home Screen, Apps and Widget

Learning the basics

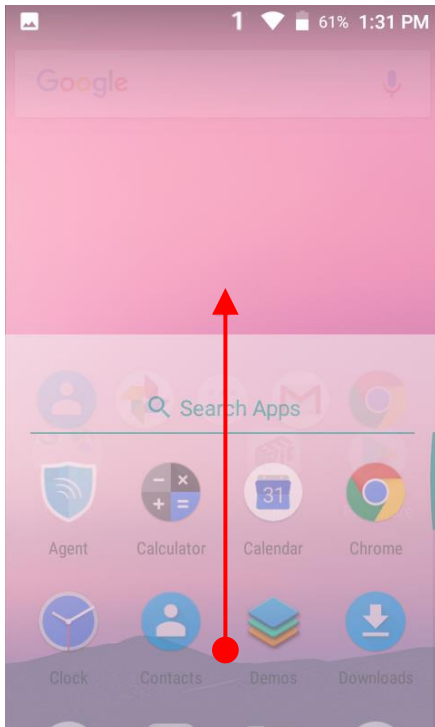

By drag up the Favorite tray apps area, you can also access to app list in your PM550

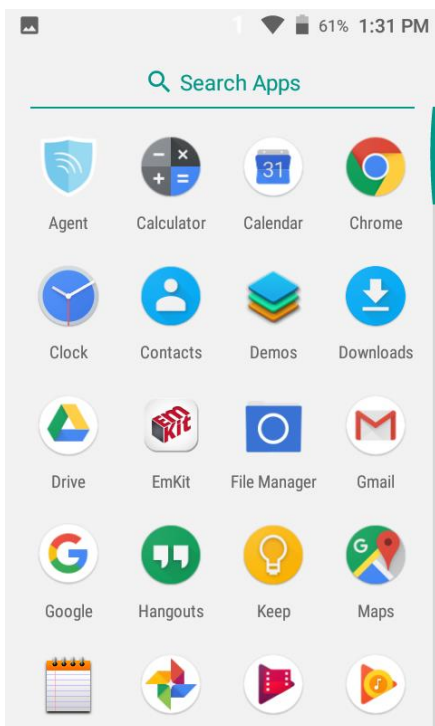

# Home Screen, Apps and Widget

## Learning the basics

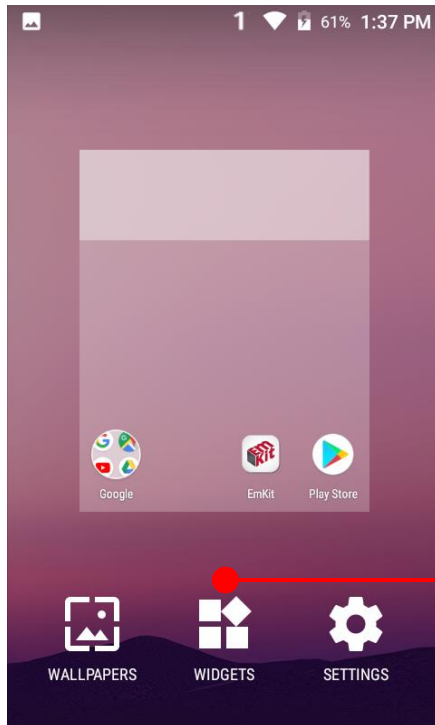

To add a Widget in the Home screen, long press the empty space. Then you will see WALL PAPERS, WIDGETS, SETTINGS menu. Touch WIDGETS

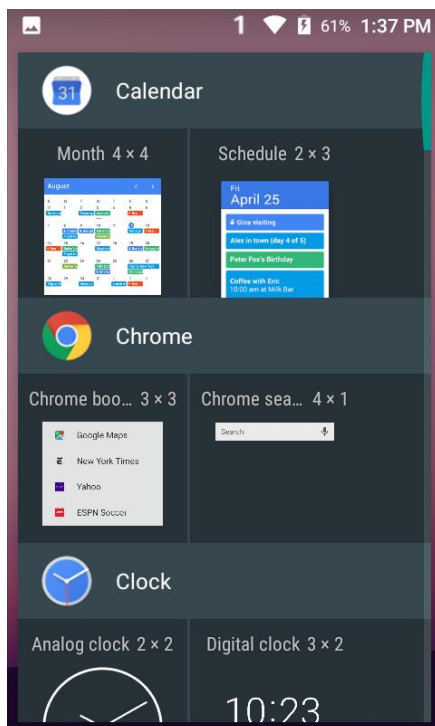

Available widgets are listed. Among the list select the widget which you want to add and place it to the Home screen by drag and release

# Home Screen, Apps and Widget

## Learning the basics

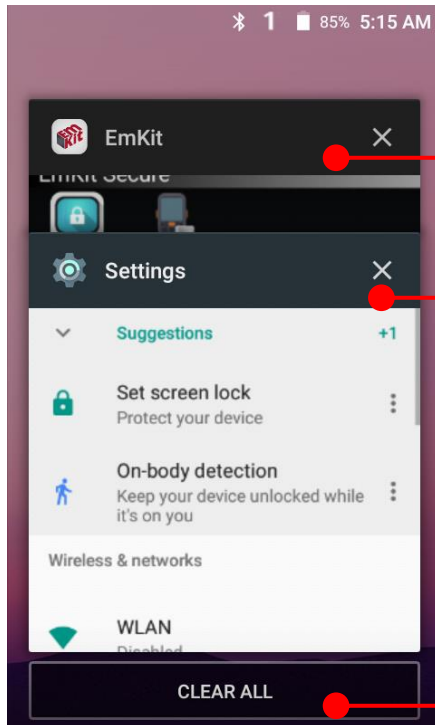

By pressing the  Recent button in the keypad, you can see app list which you access

Touch the app, if you want to use or access the app.













If you want to close individual app, long press the app and then touch  icon

If you close all of the apps, then touch CLEAR ALL button









# Status & Notifications Icons

Learning the basics

## Status icons

	WLAN is on		Connected to a WLAN network
	Bluetooth is on		Connected to a Bluetooth device
	Battery is full		Battery is partially drained
	Battery is low		Battery is very low
	Battery is charging		
	GPS is on		Alarm is set
	Vibrate mode/ Mute		



## Notification icons

	New Email		Connected to VPN network
	Upcoming event		Screenshot captured
	OTG device connected		
	File uploaded		File downloaded
	There are more notifications		Other input method available

# Connect to your Wi-Fi network

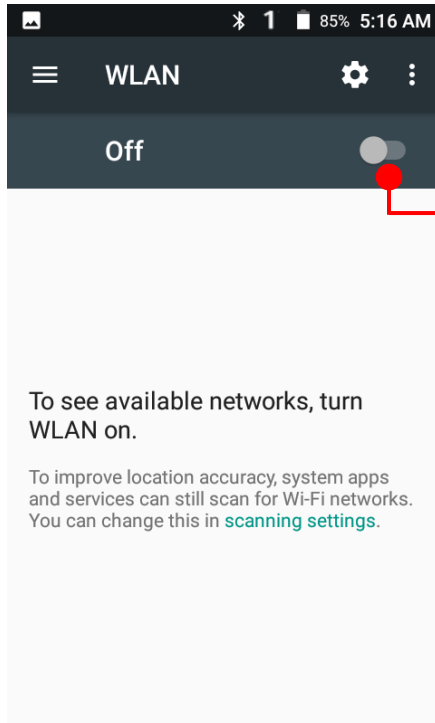
## Learning the basics



Touch  "App drawer" icon →  "Settings" and then "WLAN"

Touch to turn On/Off the W-Fi

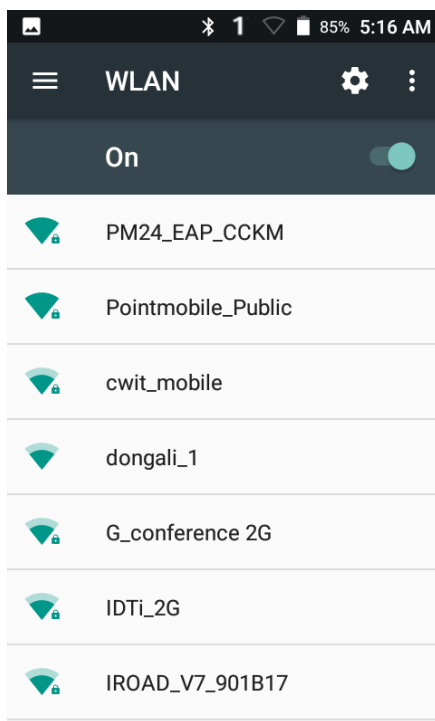

You can see nearby Wi-Fi network. Each AP's SSID information listed by signal strength



Icon means: Open Wi-Fi network. You don't need to enter the password



Icon means: Secured Wi-Fi network. To connect this Wi-Fi, you need to enter the password



## Connect to your Wi-Fi network

### Learning the basics

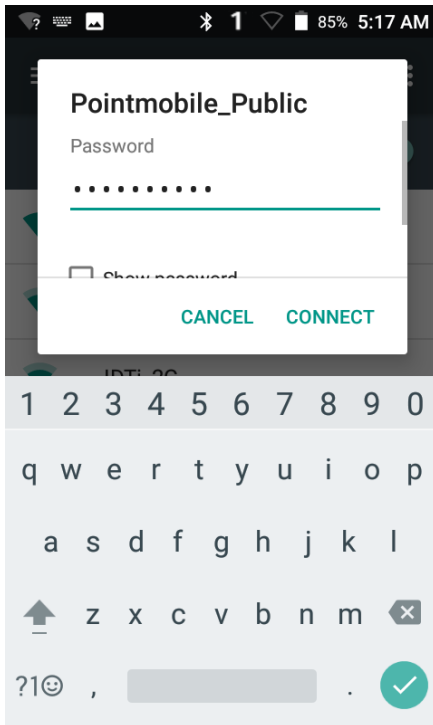

Touch SSID, which you want to connect.  
To connect to the secured Wi-Fi network, enter the password

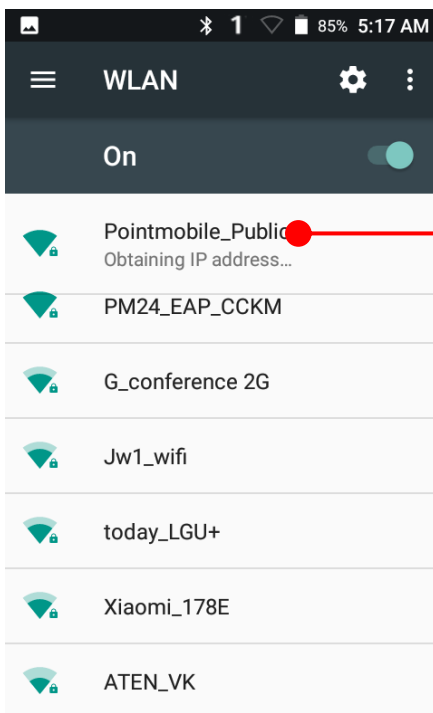

Your PM550 is obtaining the IP address from the selected AP

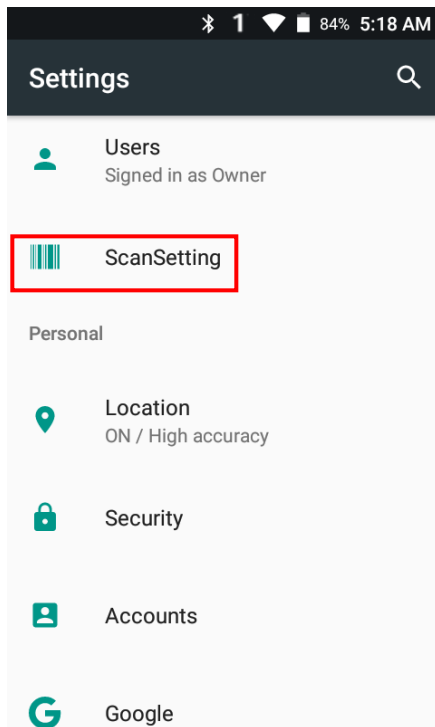

# Use a Scanner

## Scanner Settings



Default setting of Scanner is "Off"

To use the Scanner,

- Touch  EmKit and then "ScanSetting"
- Touch  "App drawer" icon →  "Settings" and then "ScanSettings"

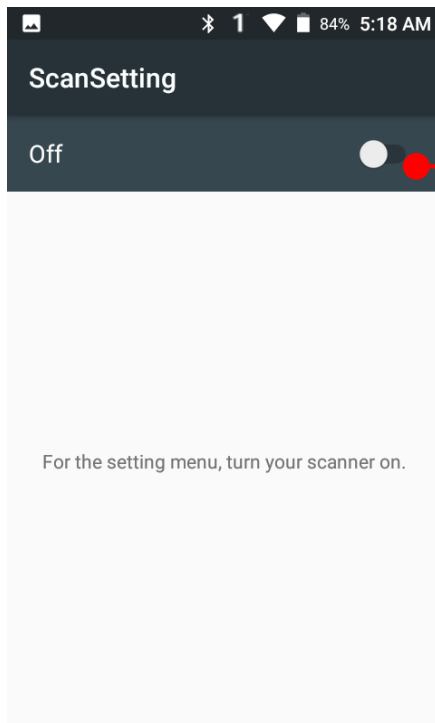

# Use a Scanner

## Scanner Settings

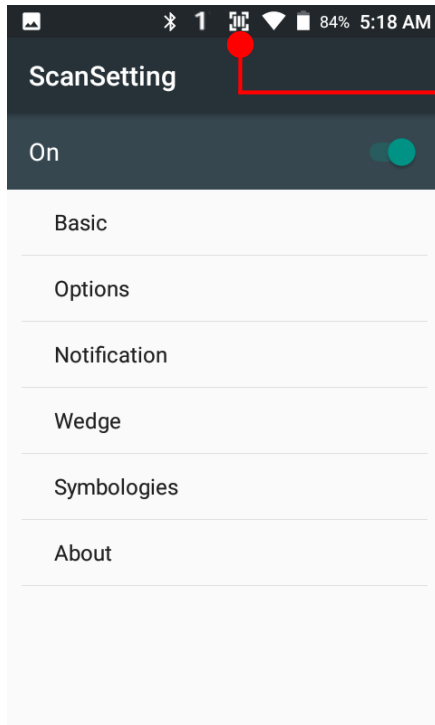

Now you can see “Scanner” icon in the “Status Bar”

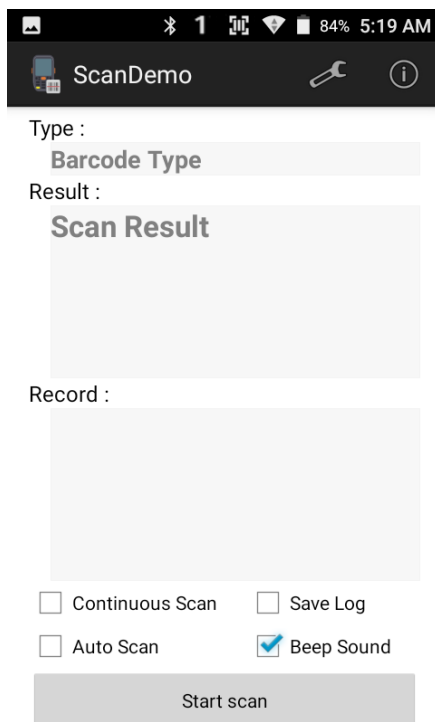

**Note:** When “Scanner” turned on, you can scan the barcode with “ScanDemo” in the EmKit

# Use a Scanner

## Scanner Settings

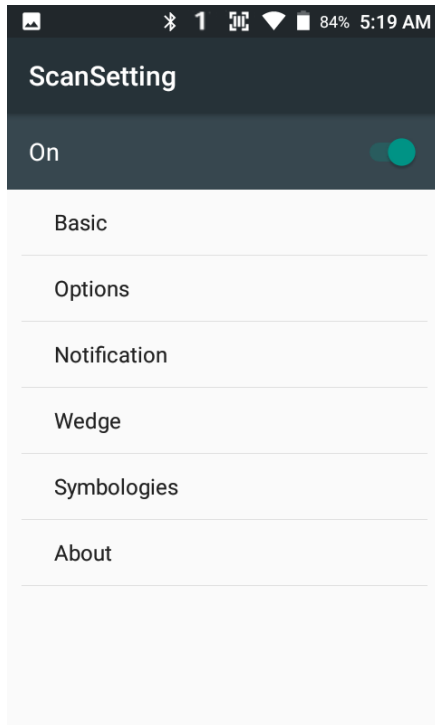

### Scanner setting details

Scanner setting consist with “Basic”, “Options”, “Notification”, “Wedge”, “Symbologies”, and “About”

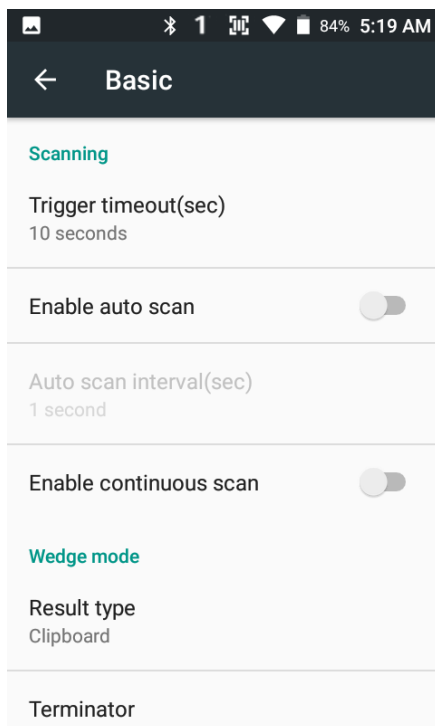

In the “Basic”, you can set “Scanning” option and “Wedge mode” option

In the “Scanning menu”, you can change Scanner’s trigger time out and set “Auto scan” & “Continues scan”

In the “Wedge menu” you can change, decode scan data’s result type handling “User Message”, “Keyboard Event”, “Clipboard’ or ‘Intent Broadcast’. Also you can set Terminator as “None”, “Space”, “Tab”, “LF” or “Tab & LF”

## Use a Scanner

## Scanner Settings

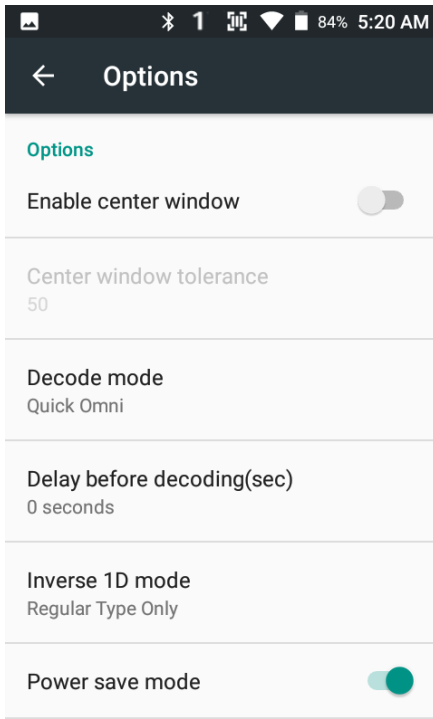

In the “Options”, you can enable/disable the “Center Window”, set “Decode mode”, “Power save mode” and enable/disable “Aimer” & “Illumination” option

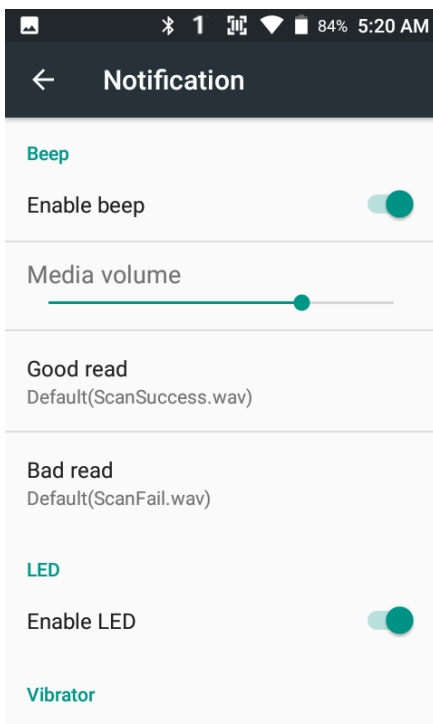

In the “Notification”, you can change the volume level, notification sound, LED and vibration option

## Use a Scanner

## Scanner Settings

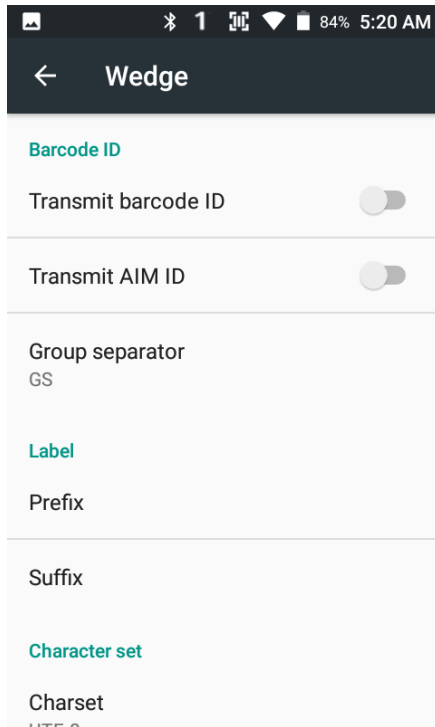

In the “Wedge”, you can enable/disable “Barcode ID” and “AIM ID”, set “Group separator”, “Prefix” & “Suffix”, “Character set” and “Extended Wedge”

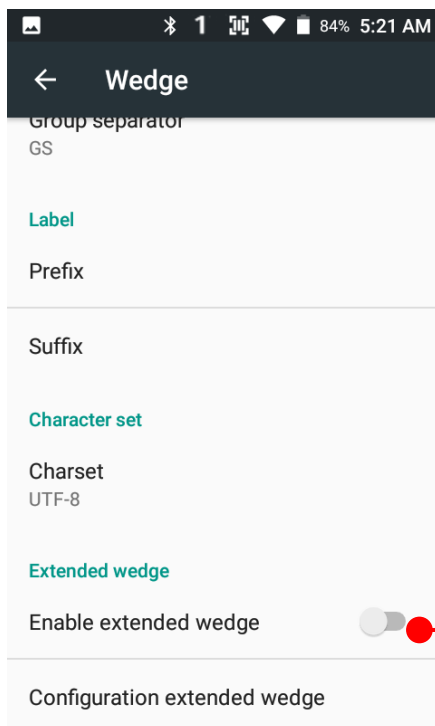

PM550 has decoded data edit function. You can add or remove specific data from decode value. To use this function, enable the option and then set a rule

## Use a Scanner

## Scanner Settings

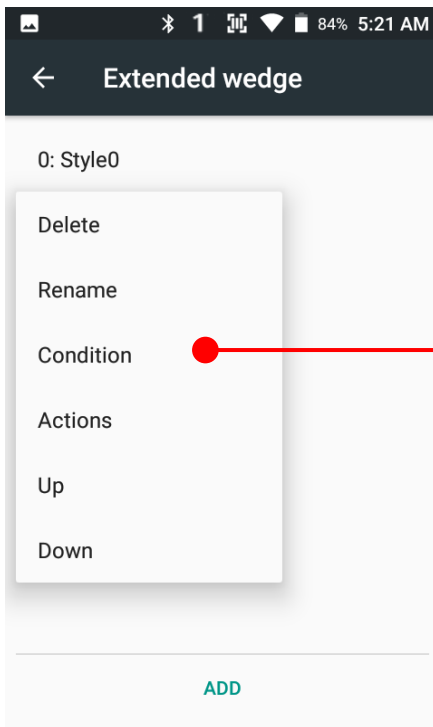

For example, whenever you decode CODE128 barcode, if you want to add “Point Mobile”, enable the Extended wedge and select “Condition” in Style

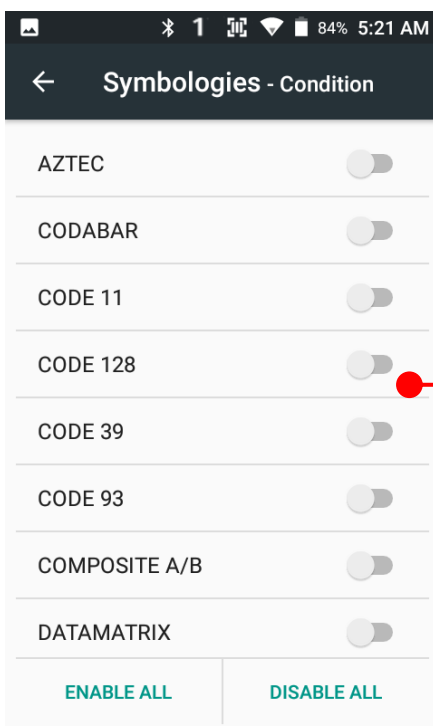

Touch CODE128 and press Back button

# Use a Scanner

## Scanner Settings

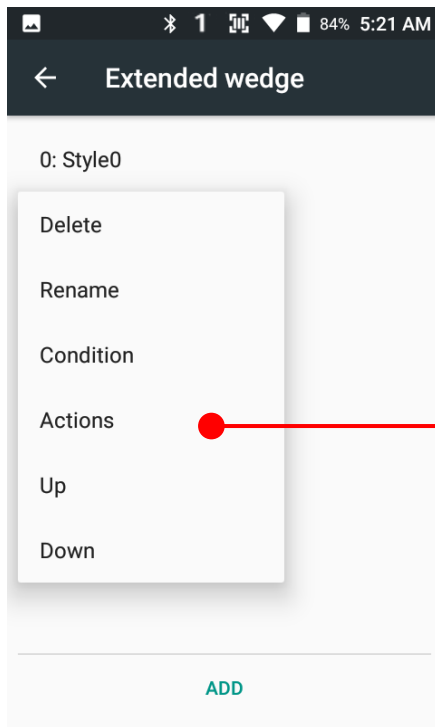

Touch Actions

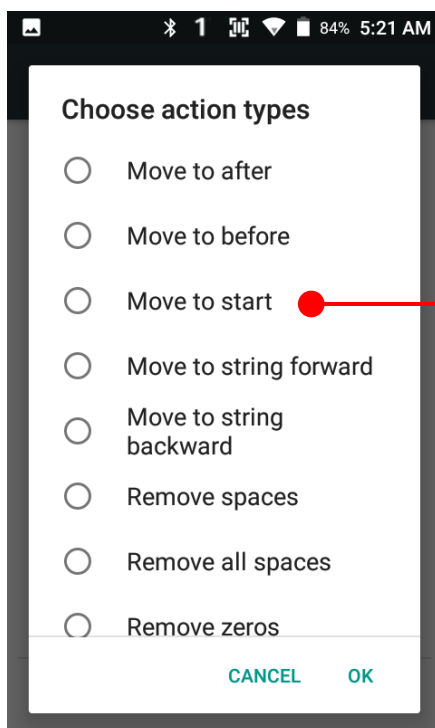

Touch "Move to start" and "Send string"  
In "Send string", edit "Value" as "Point Mobile"



## Use a Scanner

## Scanner Settings

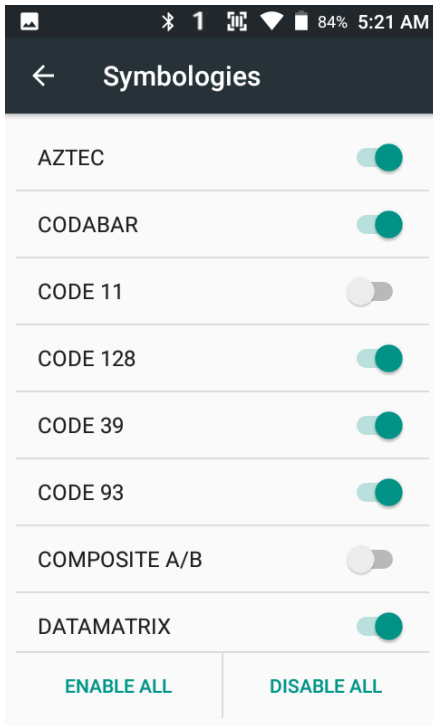

In the “Symbologies”, you can enable/disable specific barcode decoding or set a detail option.

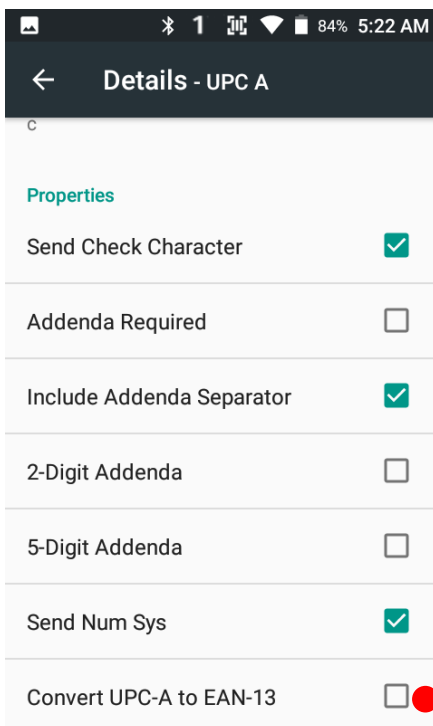

By touching each “Symbology” name, you can set detail option.

Touch the check box to enable/disable specific option at symbology

# Use a Scanner

## Scanner Settings

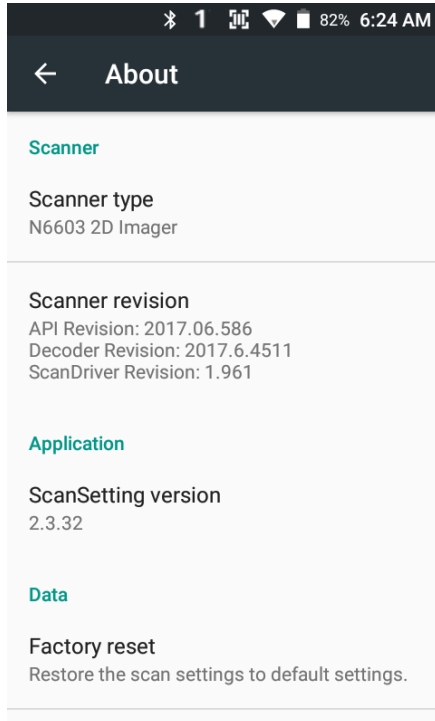

In the 'About', you can check your Scanner's information and restore Scanner's settings to default

# Scan a Barcode

## Scanner Settings

### Example of good Barcode reading



Idle barcode scan  
Please aim the middle of barcode



Even you aim the barcode slightly upper or down area or angle is slightly tilted, you can read the barcode



## Scan a Barcode

## Scanner Settings

### Example of bad Barcode reading



If you aim the barcode wrong direction or tilt too much, you can't read the barcode

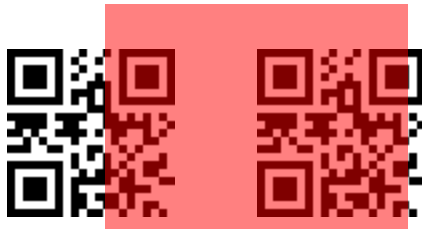



If you aim part of Barcode or aim two barcode together, you can't read the barcode

# OS Image update from Storage

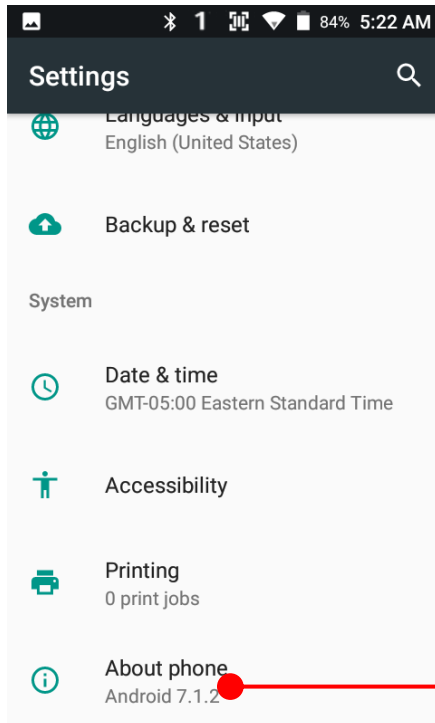
## OS Update



To update OS image, copy or place OS image file into the root folder of "Internal Storage"

Touch  "App Drawer" →  "Settings" and then "About phone"

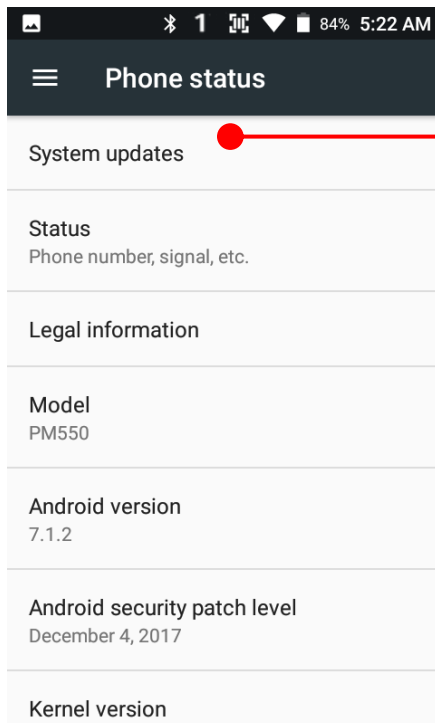

Touch "System updates"

# OS Image update from Storage

## OS Update

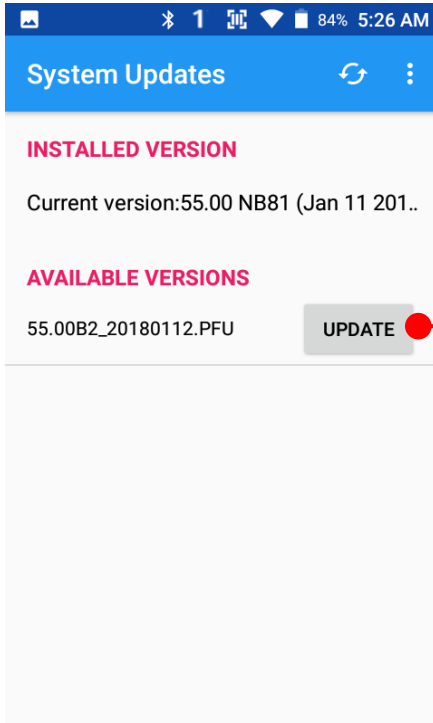

Your PM550 will check storage and display available OS image

Touch "Update" button

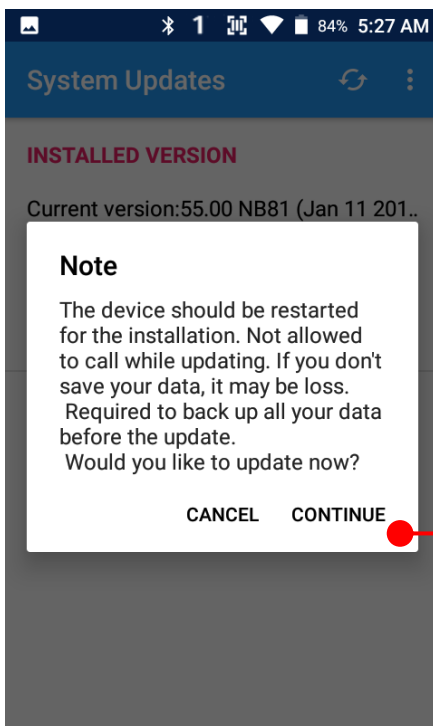

By touching the "CONTINUE" button, your PM550 start to update the OS image. During this time, you cannot use your PM550. Please save the data before start, the OS update process.

# OS Image update from OTG Port

## OS Update

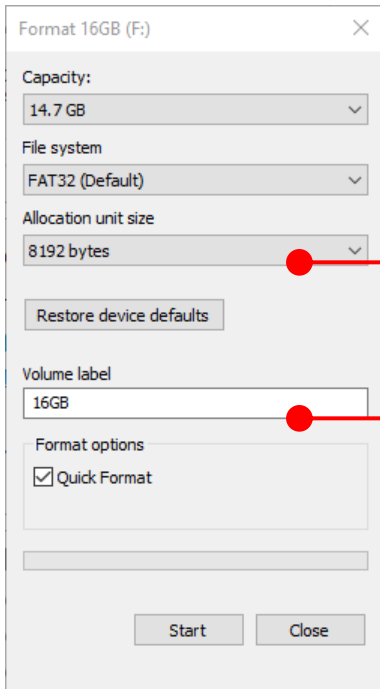

PM550 support USB OTG feature. With USB type C flash drive or OTG cable and USB flash drive combination, you can update the OS

Please format your flash drive with FAT32 option

Please set a Volume label

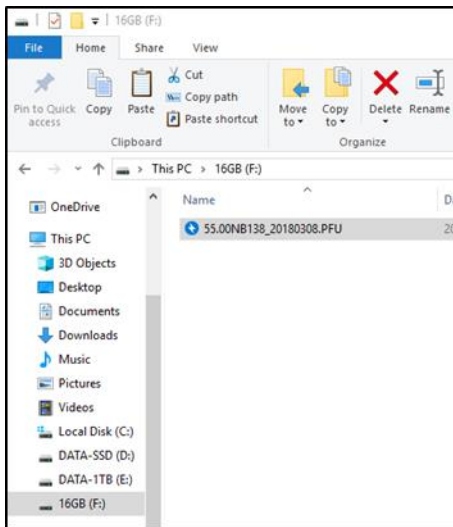

After format, please copy OS image to the root folder of the flash drive

Connect flash drive to the PM550



# OS Image update from OTG Port

## OS Update

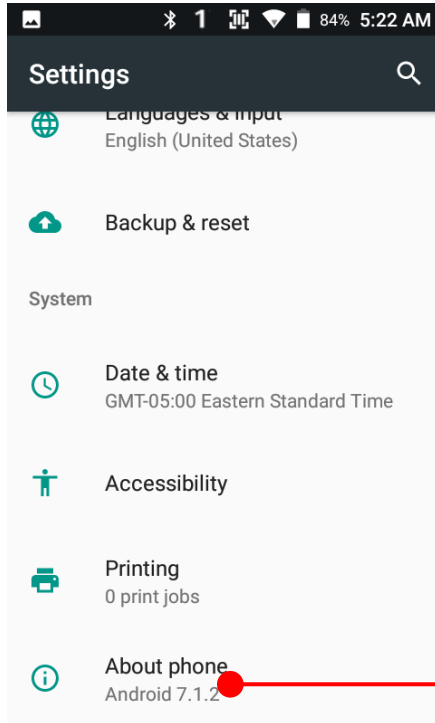

Touch  
“App Drawer”  
“About phone”



→



“Settings” and then

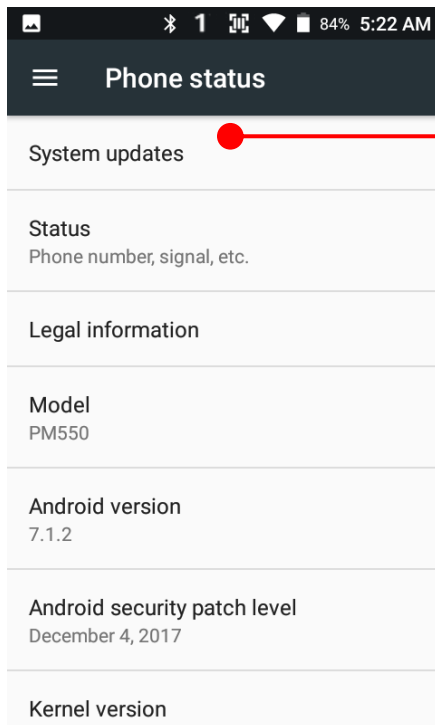

Touch “System updates”



# OS Image update from OTG Port

## OS Update

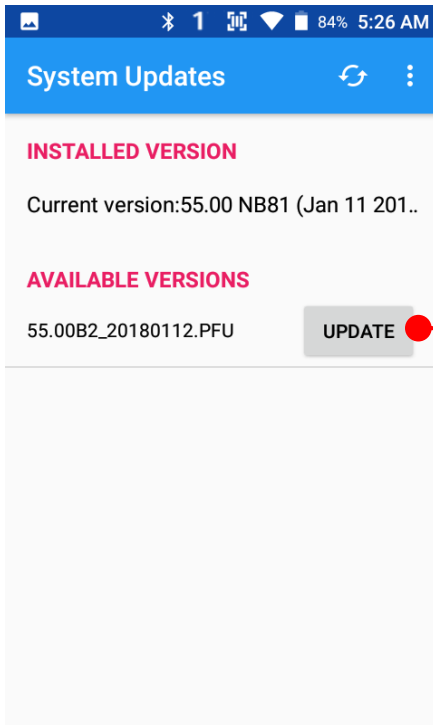

Your PM550 will check storage and display available OS image

Touch "Update" button

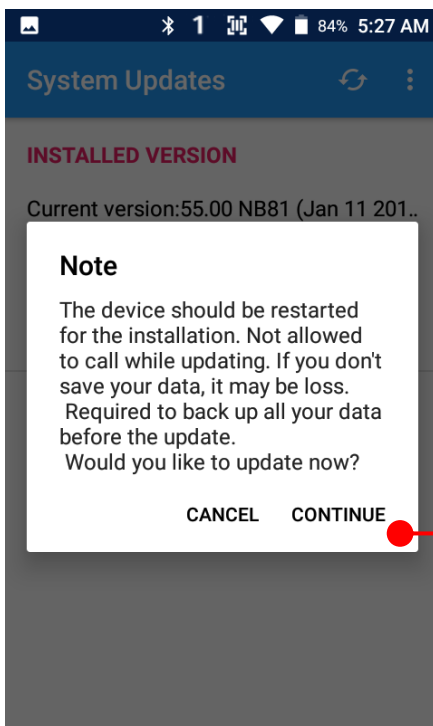

By touching the "CONTINUE" button, your PM550 start to update the OS image. During this time, you cannot use your PM550. Please save the data before start, the OS update process.

# OS Image update from the FOTA

## OS Update

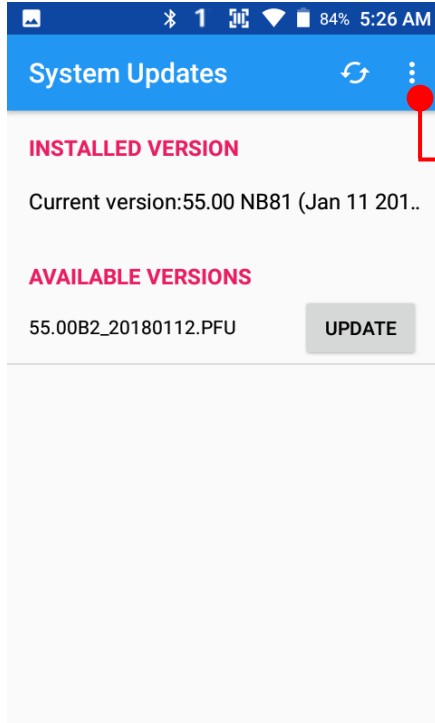

Tap  icon for the advanced option access

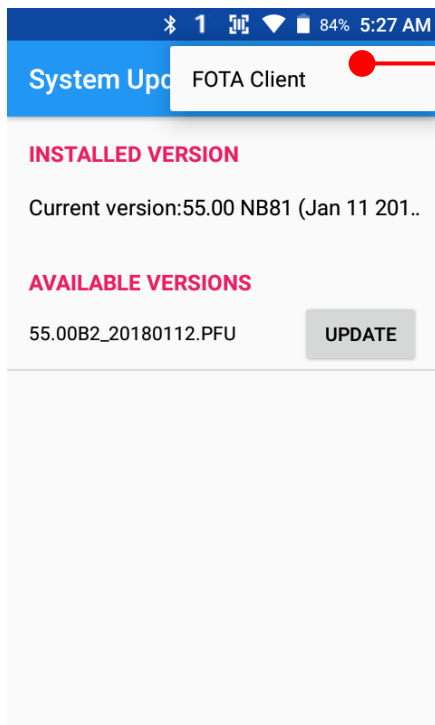

Touch "FOTA Client"

# OS Image update from the FOTA

## OS Update

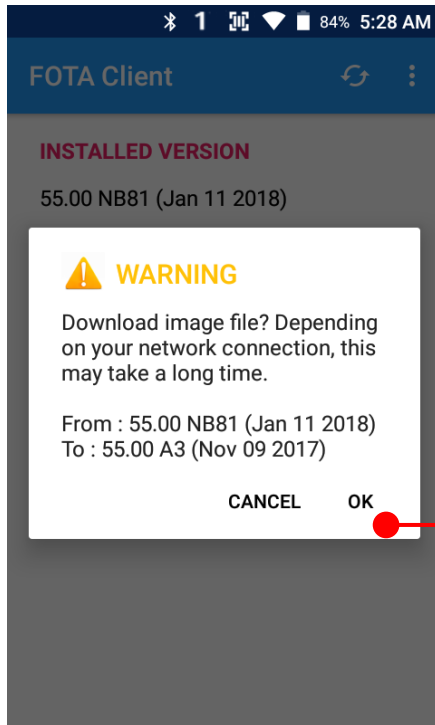

PM550 will compare the OS image between FOTA server and current OS image. If there is newer OS image in the FOTA server, FOTA server will suggest downloading.

Touch "OK" to start download the image in the FOTA server

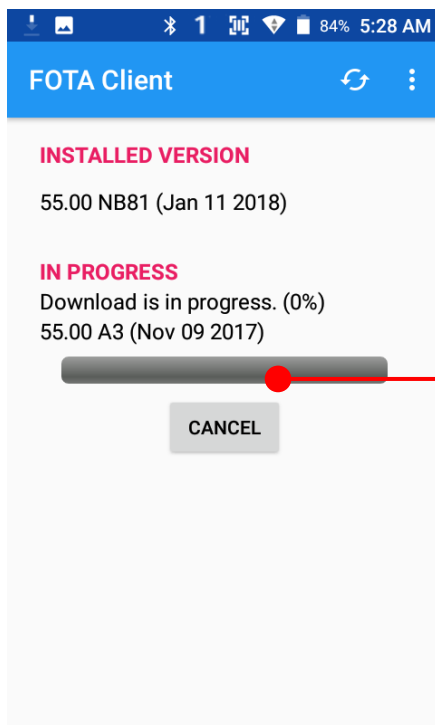

You can cancel OS image download process



**Note:** Default OS image download setting of FOTA Client is "Download over Wi-Fi only" Please connect to the nearby Wi-Fi network for FOTA service

# Factory data reset from Settings

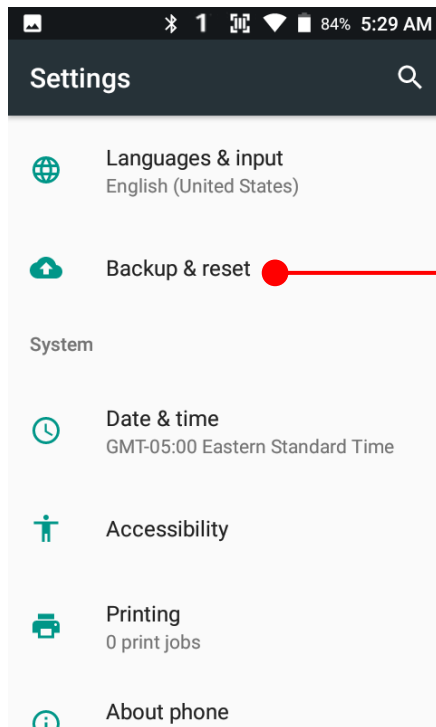
## Factory data reset



When your PM550 system is unstable and abnormal behavior occur but could not recover by rebooting, you may need to “Factory data reset” your PM550

Touch  “App Drawer” →  “Settings” and then “Backup & reset”

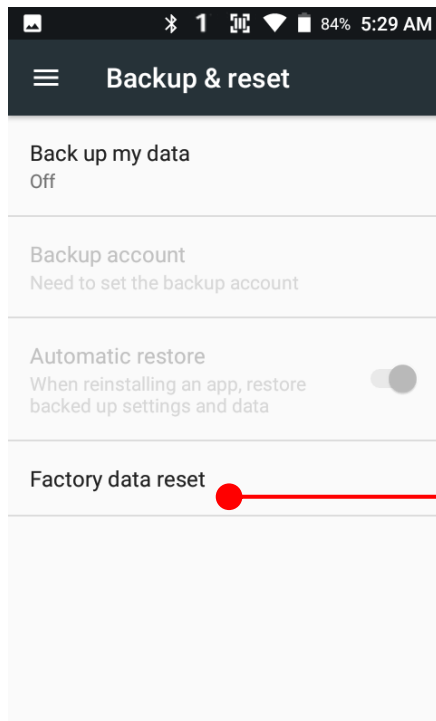

Touch “Factory data reset”

## Factory data reset from Settings

## Factory data reset

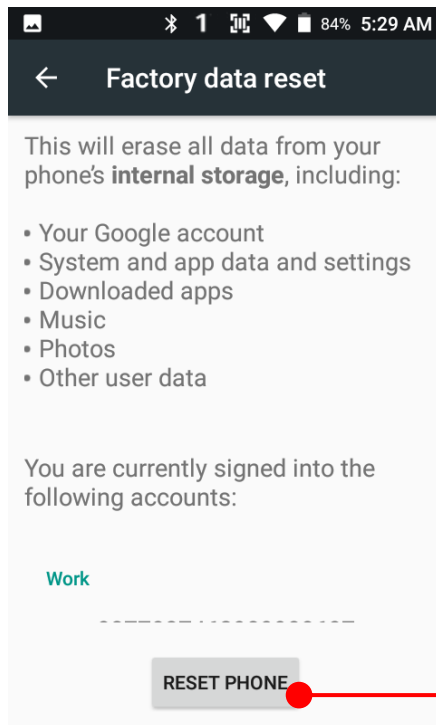

Please note, all apps and data in the internal storage will be deleted and restored to “Factory default” and this process cannot “Undo”

Touch RESET PHONE button to start “Factory Reset” process

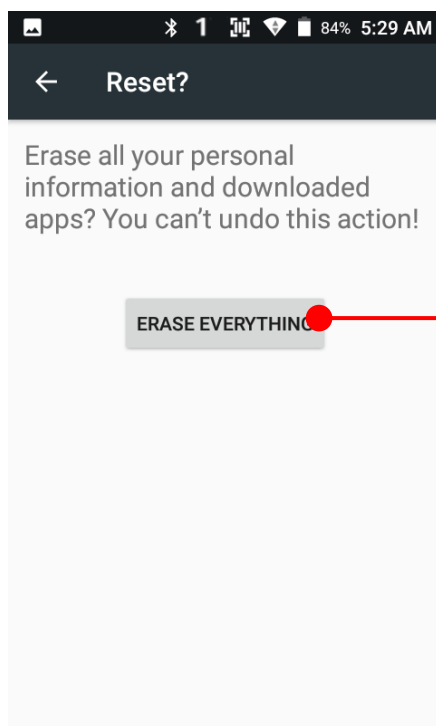

Touch ERASE EVERYTHING button to confirm erase of “Apps and Data”

## Force Factory data reset

## Factory data reset



### Force Factory data reset your PM550

You can perform “force” factory data reset your PM550. When your PM550 turned off, press “Power” + “Recent” + “Back” button all together. After short vibration from your PM550, you may release the buttons.



PM550 enter to the “Android Recovery” mode. In this mode, all key pad pressing move down the menu tree and “Power Button” is “Select”

---

## Force Factory data reset

## Factory data reset



Select "Wipe data/factory reset"



Select "Yes" to perform the "Factory data reset"  
After that, your PM550 start wiping the data

## Force Factory data reset

## Factory data reset

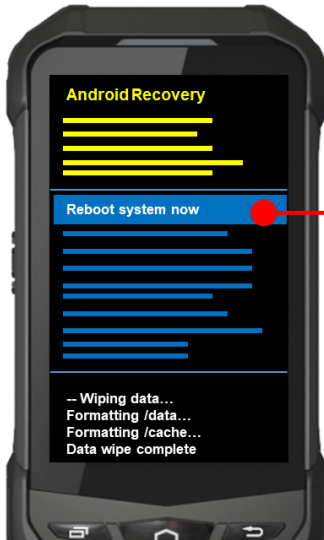

After data wiping, please select “Reboot system now” to finish the “Force Factory data reset” process

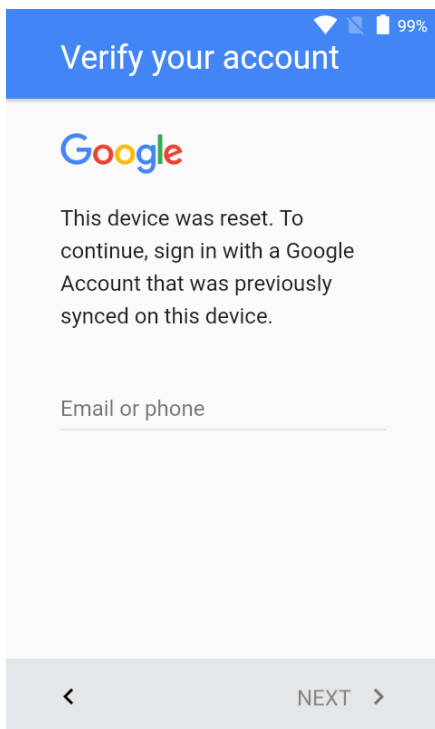

After Force factory reset, if PM Android Device locked by Factory Reset Protection, then please enter to Fast Boot mode and execute command

- fastboot erase config
- fastboot reboot

**Note:** Factory Reset Protection (FRP) is a security method that was designed to make sure someone can't just wipe and factory reset your device if you've lost it or it was stolen



# Enterprise Mobility Kit

EmKit

## Enterprise Mobility Kit – Truly, what Enterprise needs

Point Mobile announces new software solution – called “EmKit” is new software solution for enterprise mobility users. Our every Android device shall have EmKit pre-installed and every user can access them for free of charge\*. EmKit offers truly-value-added advantages, for enterprise users, which are against consumer-centric & non-customizable smartphones. Every solution in EmKit is 100% compatible with Point Mobile Android GMS certified devices.

\* Necessary MDM license subjects upon individual subscribers

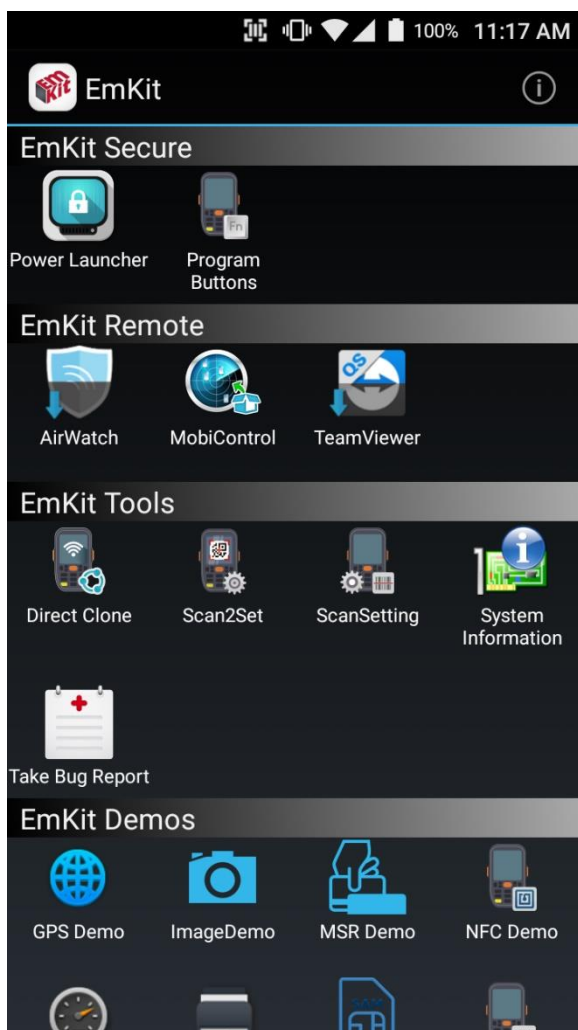

EmKit consist with “**EmKit Secure**”, “**EmKit Remote**”, “**EmKit Tools**” and “**EmKit Demos**”

- EmKit Secure “Lock Your Device”
- EmKit Remote “Mobile Device Management”
- EmKit Tools “Smarty Tools Ease Enterprise”
- EmKit Demos “Friendly For Programmers”

# EmKit Secure

EmKit

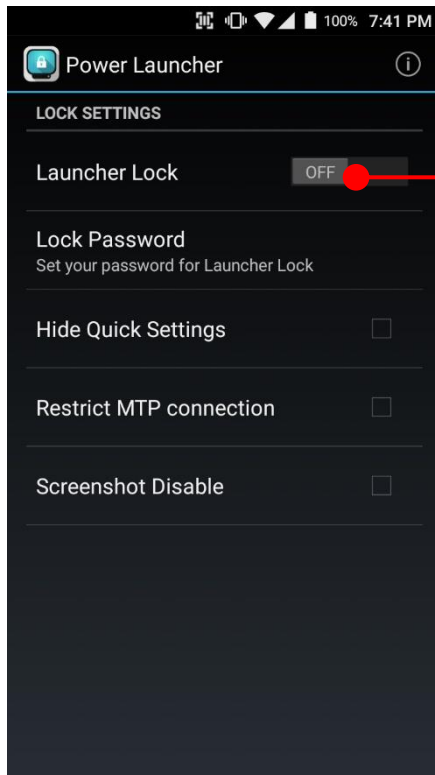

## Power Launcher

You can lock your Point Mobile Android model's **Home Screen** and limit to access app drawer or specific function. This function as known as **Kiosk mode**.

- Hide Quick Settings : Limit to access quick setting panel
- Restrict MTP connection : Limit to access Point Mobile Device's MTP connection
- Screenshot Disable : Disable screenshot capture in OS level

Restriction feature will be keep added.

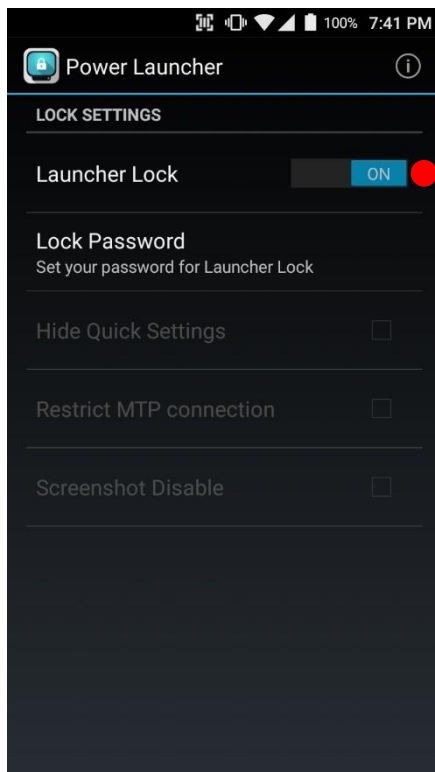

After restriction feature check, switch **Launcher Lock** to On.

# EmKit Secure

## EmKit

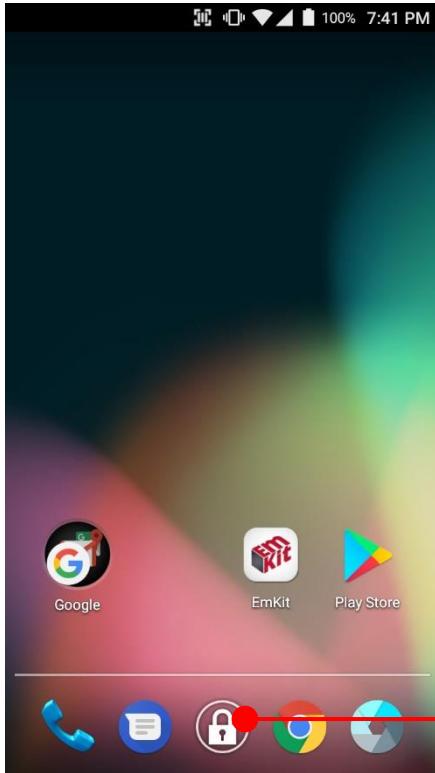

When Power Launcher is locked, operator could not access to **App drawer**.

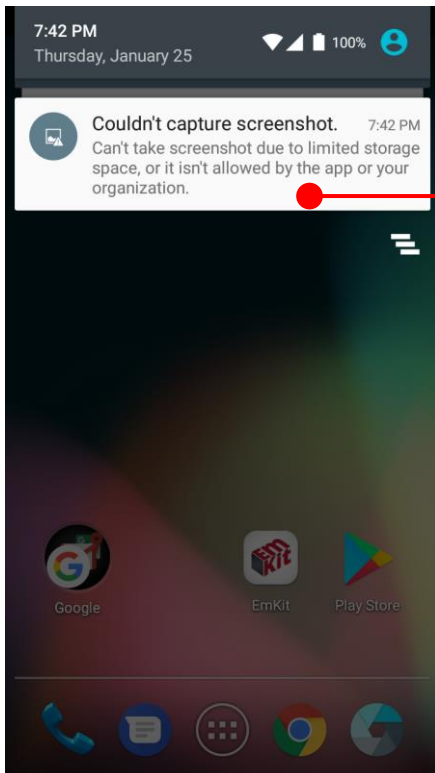

Example of **Screenshot Disable** restriction.

# EmKit Secure

EmKit

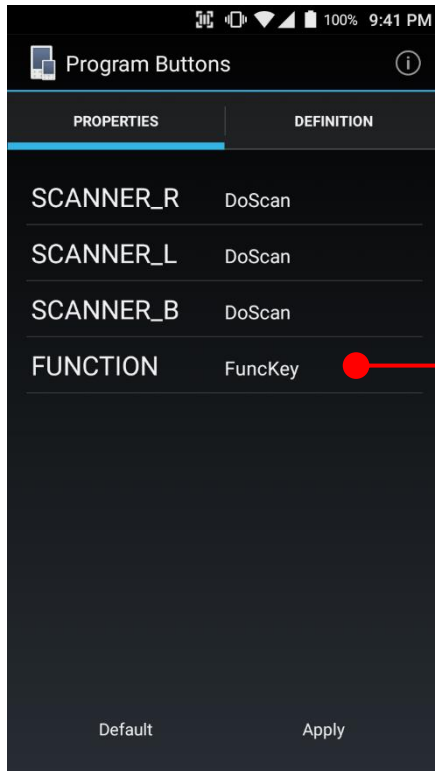

## Program Buttons

You can assign Hardware buttons function to rich pre-assigned functions.

Also you can applying the customized KCM file (Key Character Map Files) here.

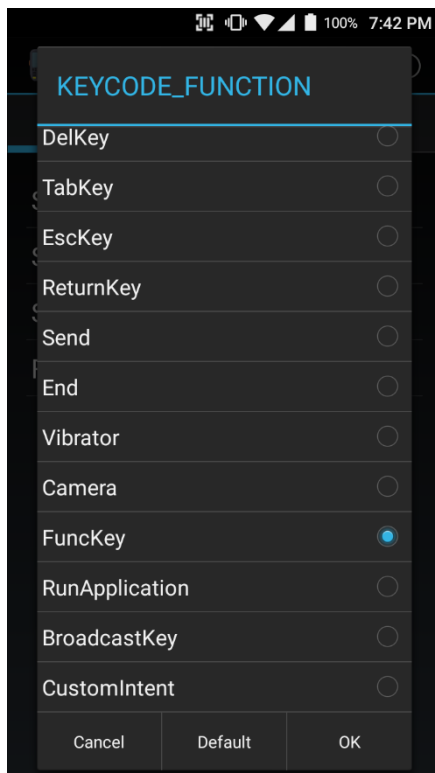

# EmKit Remote

## EmKit

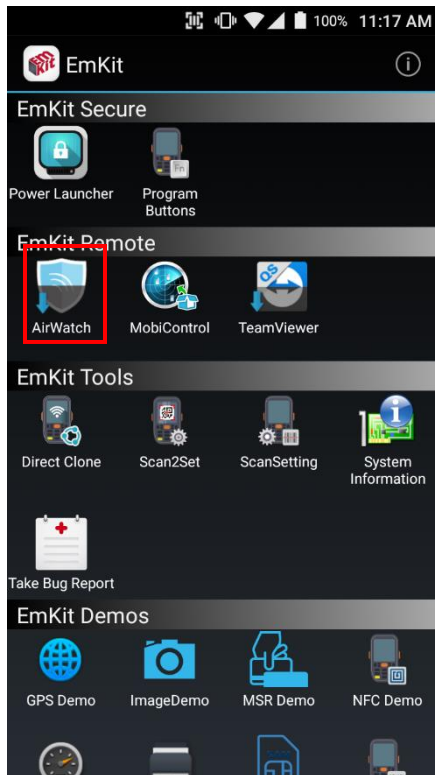

To install the AirWatch agent to Point Mobile Android device, please touch AirWatch icon

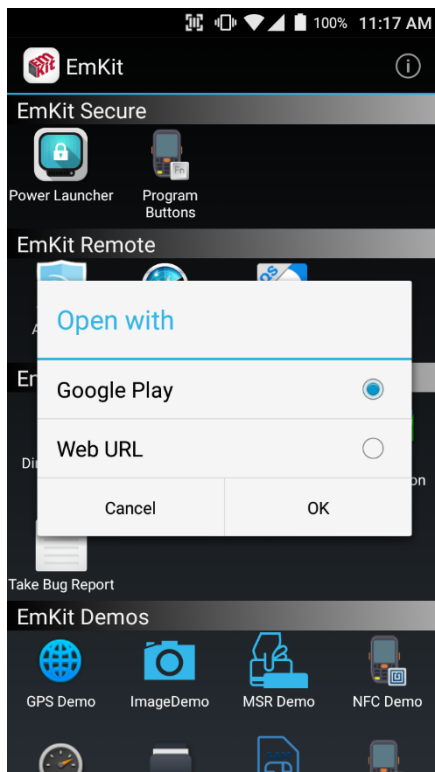

App provides AirWatch agent install via Google Play or Web URL.

- Google Play method requires Google account login. AirWatch agent download and install managed by Google Play
- Web URL method requires user's manual installation

## EmKit Remote

## EmKit

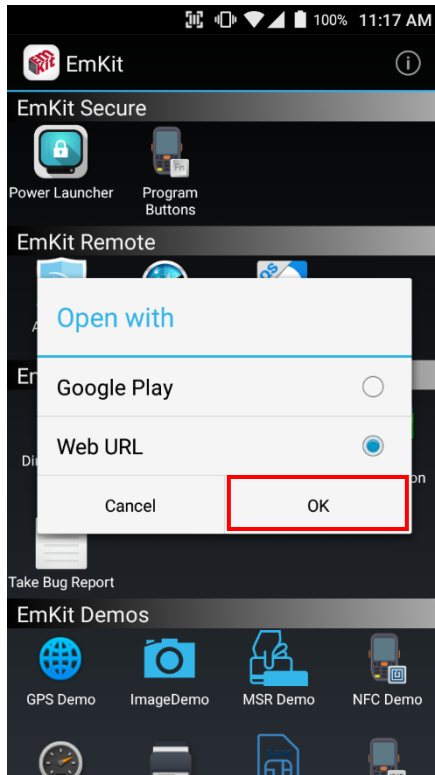

To install AirWatch agent from Web URL method, select Web URL and then **OK**

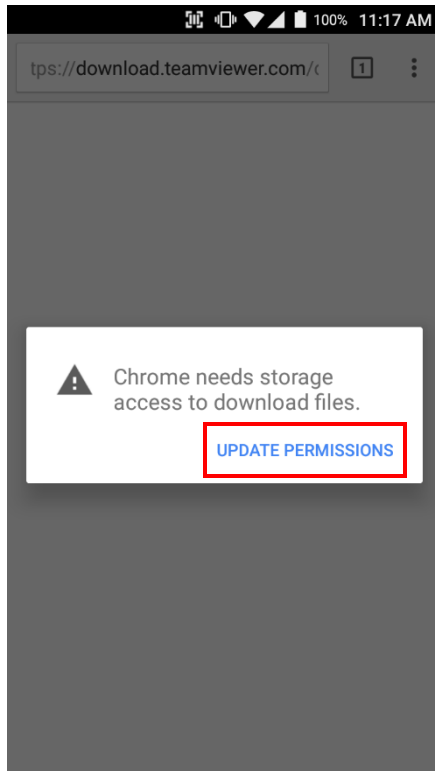

Web browser will download the apk file to the Point Mobile Android device. Before downloading, browser need permission to download apk file to the storage. Please touch **Update Permissions** button

## EmKit Remote

## EmKit

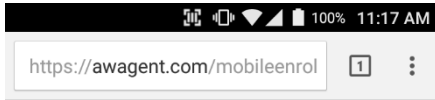

After permission update, web browser download the latest version of AirWatch agent apk file. Install this apk file to Point Mobile Android device.

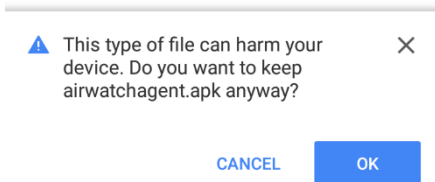

**Note:** If you need to install specific agent version, please contact to AirWatch

## EmKit Remote

## EmKit

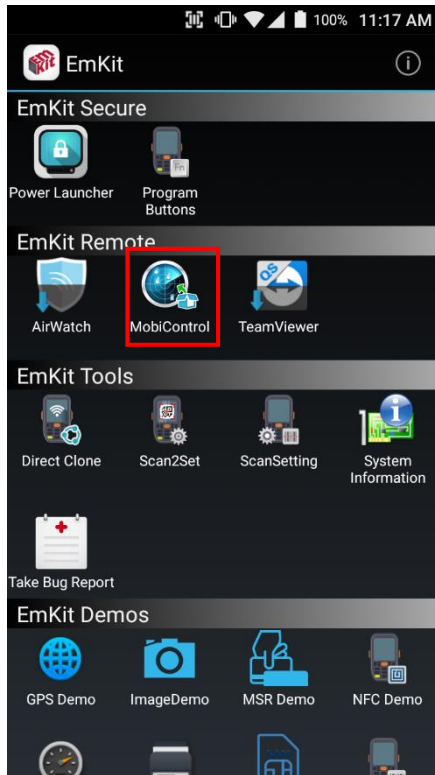

SOTI Mobi Control installer is pre-installed to Point Mobile Android device. To start enrollment process, please touch MobiControl icon

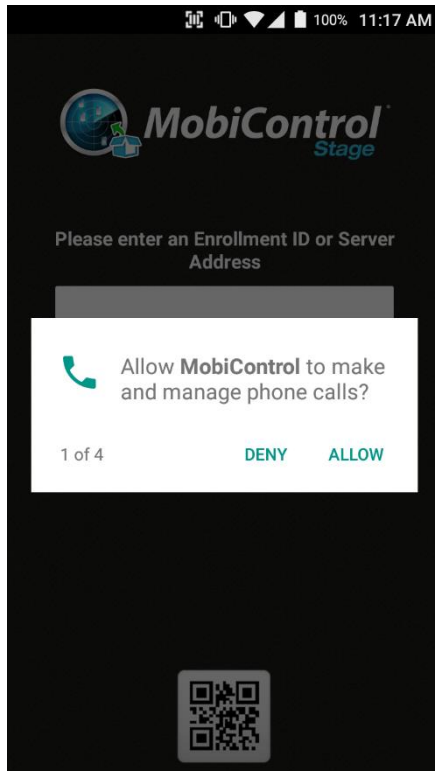

Mobi Control app request permission grant during enrollment process. Please allow it.



# EmKit Remote

## EmKit

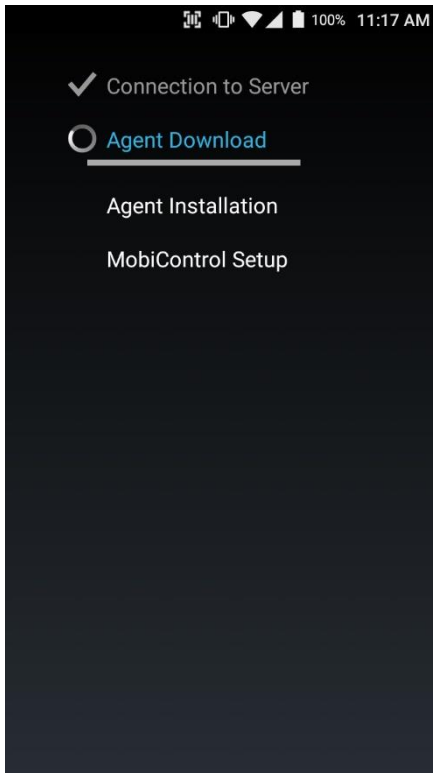

After login, Mobi Control app communicate with SOTI server and then install the Mobi Control agent

**Note:** Agent version determine from SOTI console's setting. If agent version is incorrect after enrollment, please contact to SOTI

# EmKit Remote

## EmKit

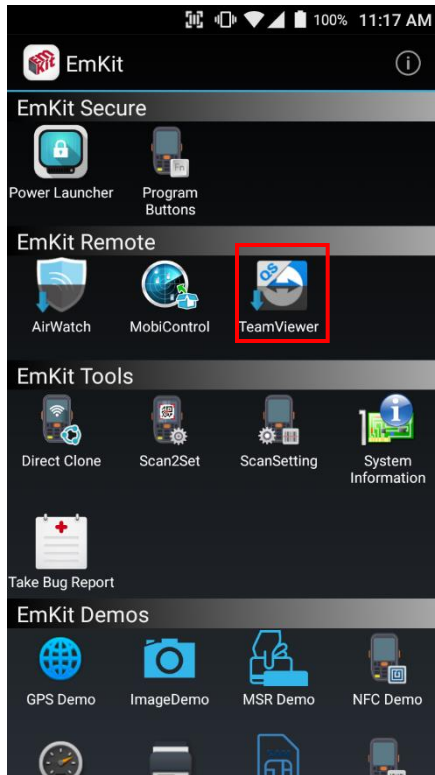

To install the TeamViewer QS app to Point Mobile Android device, please touch TeamViewer icon

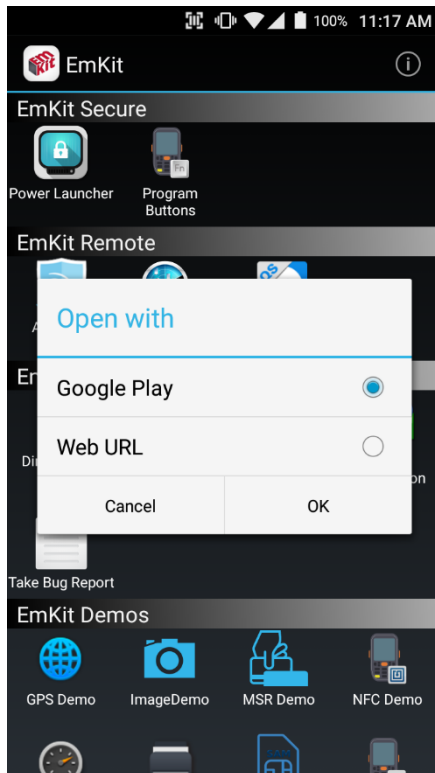

App provides TeamViewer QS app install via Google Play or Web URL.

- Google Play method requires Google account login. TeamViewer QS app download and install managed by Google Play
- Web URL method requires user's manual installation

## EmKit Remote

## EmKit

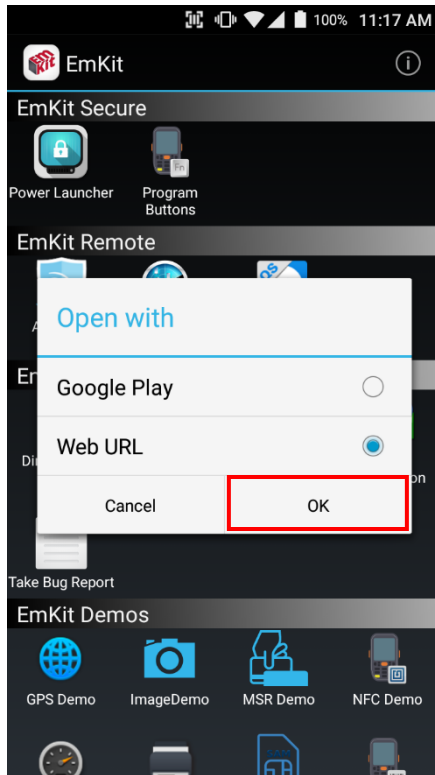

To install TeamViewer QS app from Web URL method, select Web URL and then **OK**

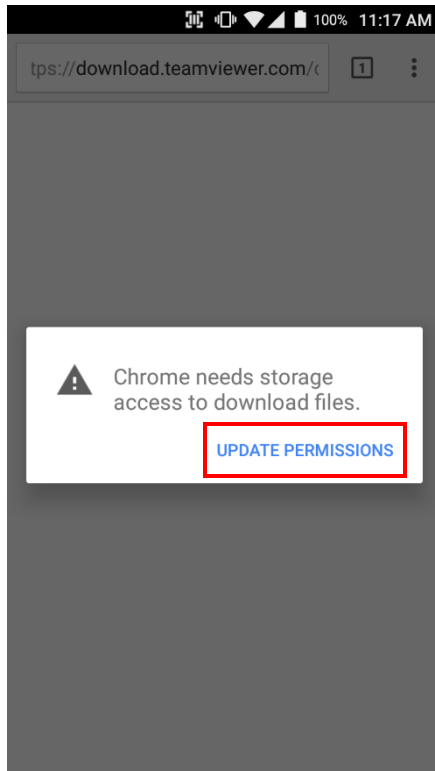

Web browser will download the apk file to the Point Mobile Android device. Before downloading, browser need permission to download apk file to the storage. Please touch **Update Permissions** button

## EmKit Remote

## EmKit

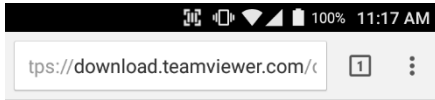

After permission update, web browser download the latest version of TeamViewer QS apk file. Install this apk file to Point Mobile Android device.

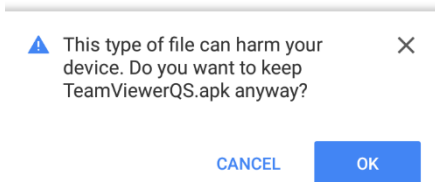

**Note:** If you need to install specific TeamViewer QS version, please contact to TeamViewer

# EmKit Tools

## EmKit

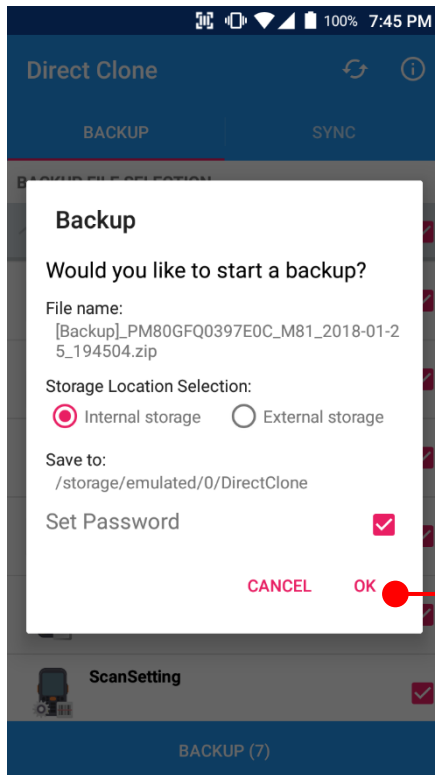

### Direct Clone

Create the **Master PDA** - backup your system settings and apps into a secured file. Without any network connection, Master PDA become a local server in your work place. Nearby Point Mobile device will automatically communicate with Master PDA and download the backup file and then **Restore**.

Create the backup file

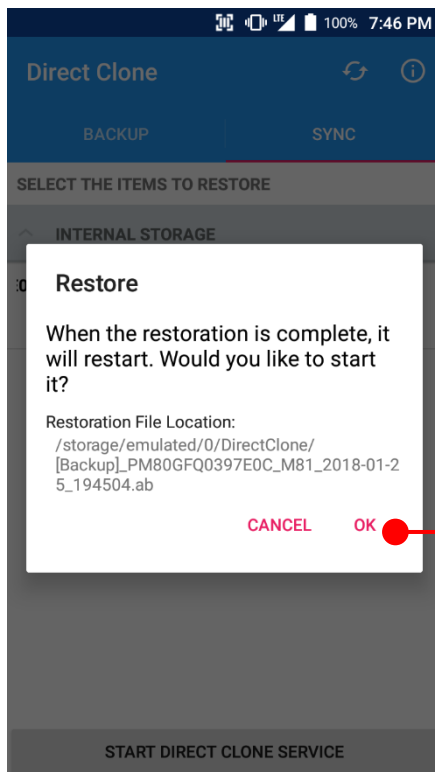

Backed up file will restore your Point Mobile Android device.

# EmKit Tools

## EmKit

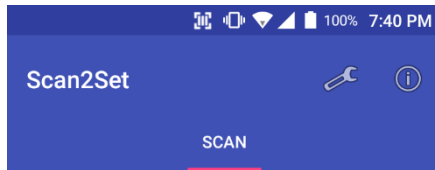

### Scan2Set

Scan2Set is designed for the network environment. Point Mobile Android device downloads the Direct Clone file from the FTP, Web server and Google Drive with just one QRcode Scan!



Scan your QR code and,

- Connect to your network
- Restore your PDA
- Work Managed Device setup

SCAN START

### Step 1. Create Direct Clone Backup file

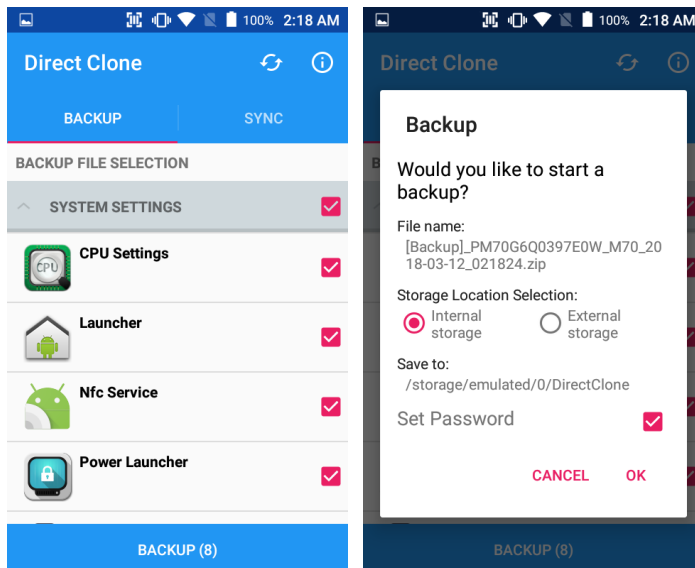

- Make a Direct Clone file from Master PDA device

# EmKit Tools

## EmKit

### Step 2. Upload Direct Clone file to your FTP site or Web server

- Copy the Direct Clone file from the Point Mobile Android device

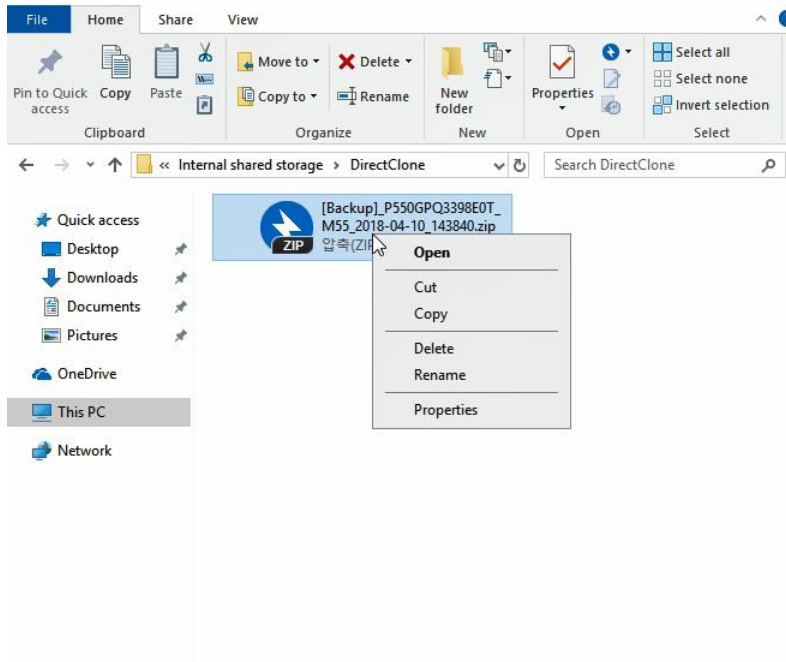

- Upload this file to your FTP site or Web Server. You may change file name

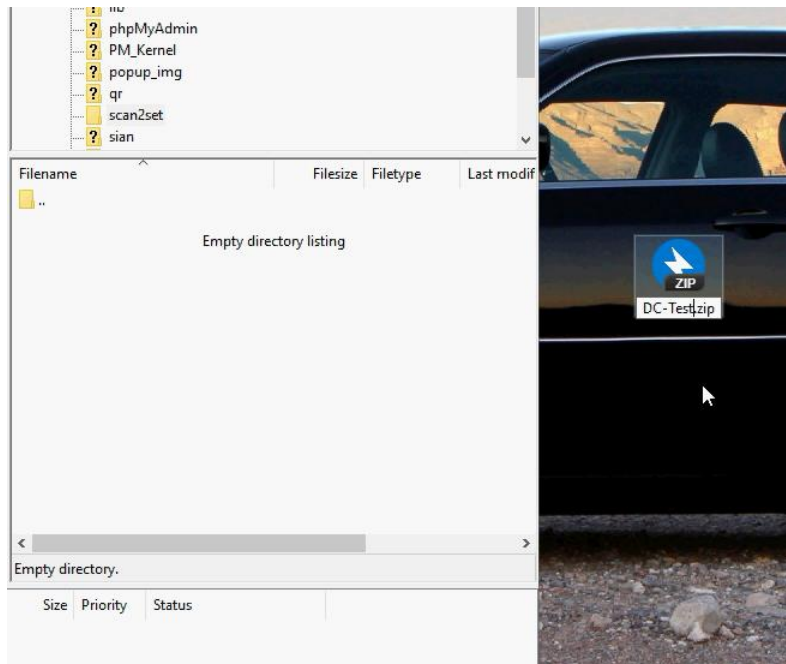

# EmKit Tools

## EmKit

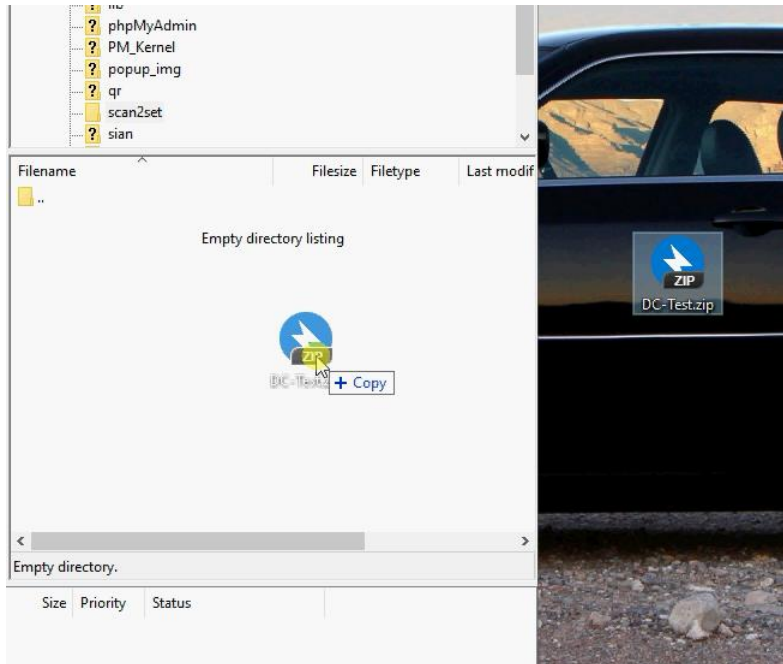

- After file uploading, please check the url first. File should be download with url address.

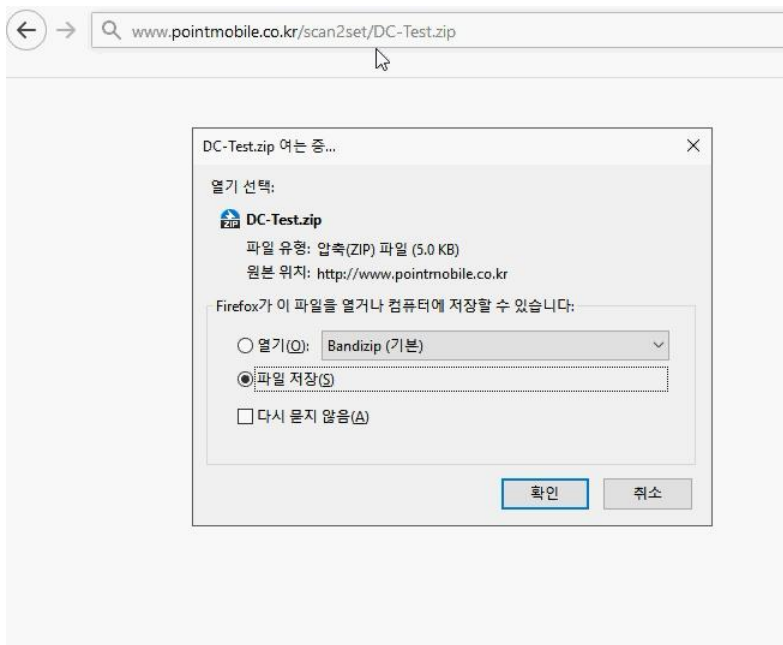



# EmKit Tools

## EmKit

### Step 3. Generate QRcode

- Access to Web QRcode generating site [www.pointmobile.co.kr/qr](http://www.pointmobile.co.kr/qr)

- Click **Web/Google Drive** menu
- Input Network information, Direct Clone file name and password

# EmKit Tools

## EmKit

Web/Google Drive  
FTP  
Work Managed Device Enrollment  
json format

QR Code Generator for Scan2Set (v1.3.2)

Network Setup

SSID:   
 Hidden

Password:

Security Type:  None  WEP  WPA,WPA2,WPA2PSK

Direct Clone File Location

URL:

File Name:

Password:

**Note:** Make sure put http:// or https:// in front of url address

- Click **Generate QRcode** button and save or print generated QRcode

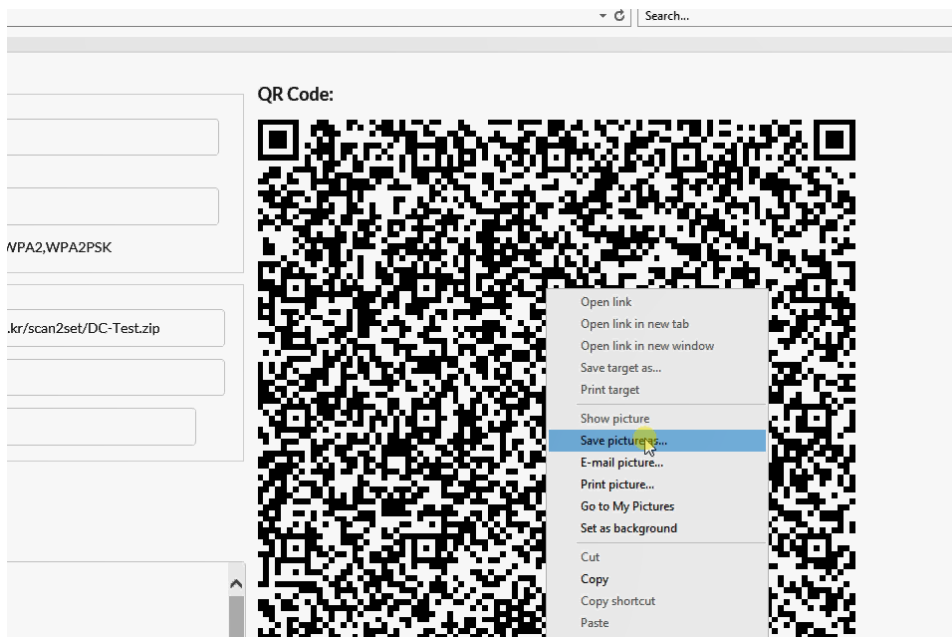

# EmKit Tools

## EmKit

### Step 4. Read QRcode in other PDAs

- Turn on your Point Mobile Android device.
- Press the Power Button, then you will see the Scan2Set in the menu

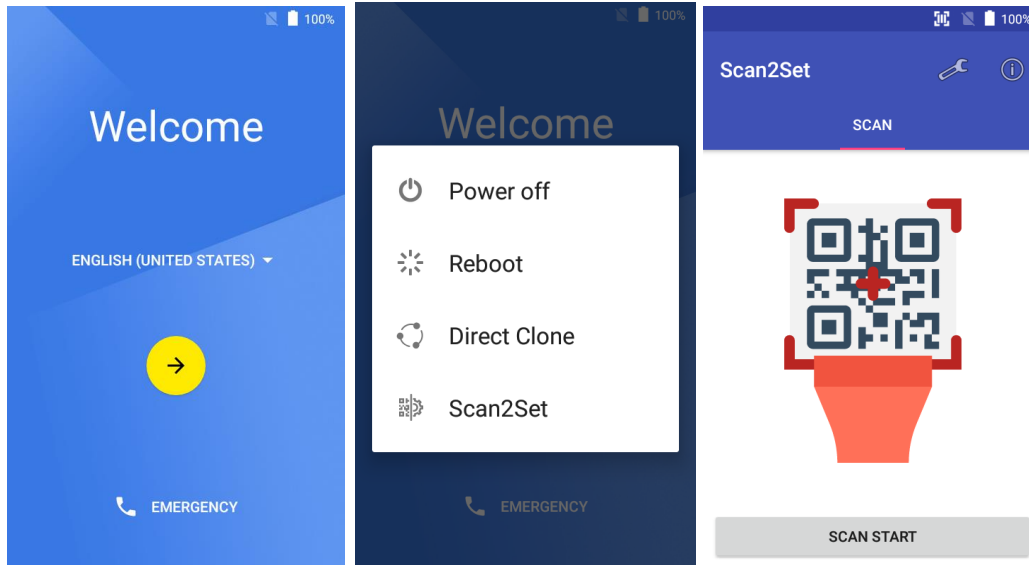

- Read the generated QRcode. Point Mobile Android device will download the file from the FTP site or Web server and restore Direct Clone file

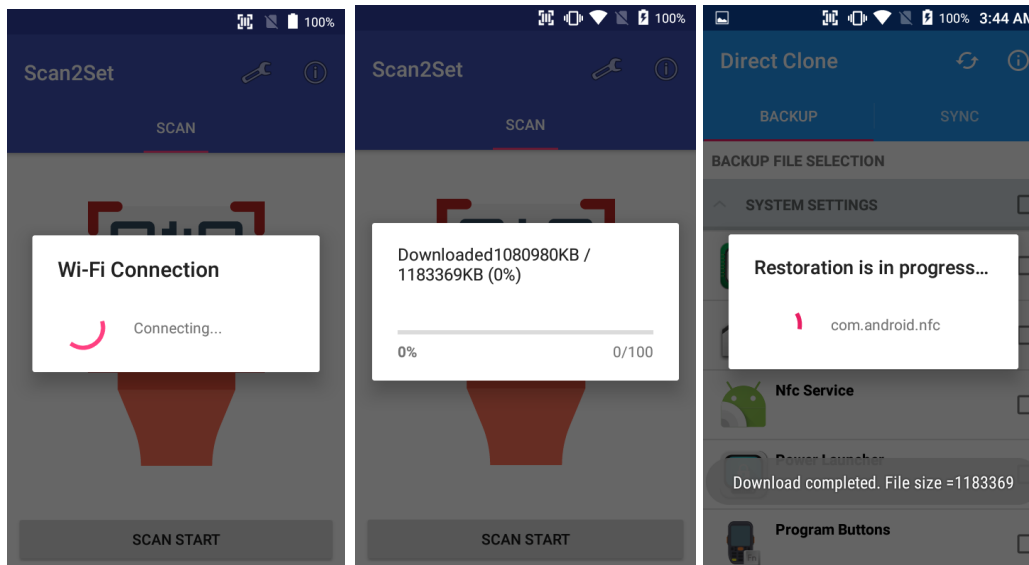

# EmKit Tools

## EmKit

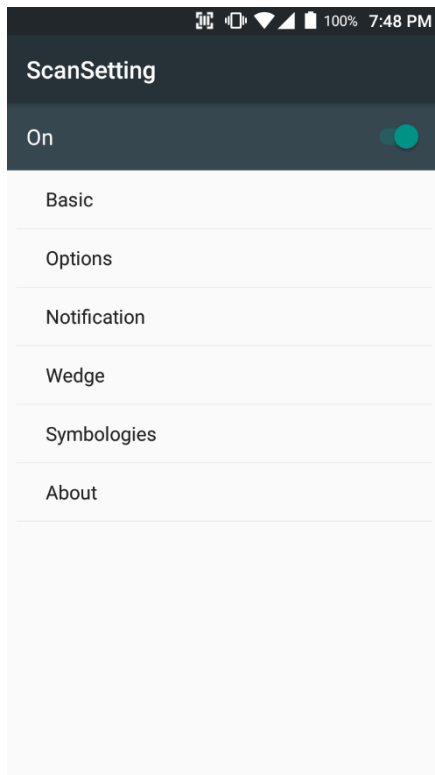

### ScanSetting

You can set your PM80's scanner option with intuitive menu.



### System information

All of SW and HW information available here and can save it to the file.

- Touch **Save to file**.
- **devinfo.html** file saved to root folder of the internal storage.

# EmKit Tools

## EmKit

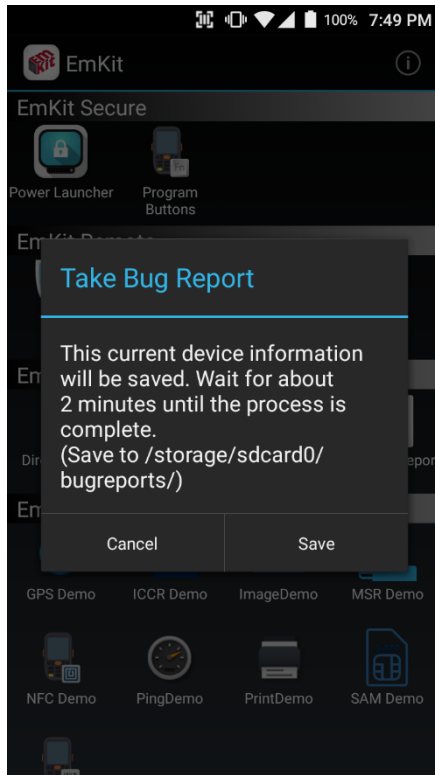

### Take Bug Report

This function save logs and event to the internal storage. When you have a field issue, and need to contact service center, please find the reproduce step first.

- Reproduce the issue.
- After issue, reproduce, please run **Take bug report**.
- File will be saved to **bugreports** folder.
- Copy the file to the PC and then zip it to reduce the file size.
- Share bug report file to the service center or Point Mobile Support team with reproduce steps.

# EmKit Demos

## EmKit

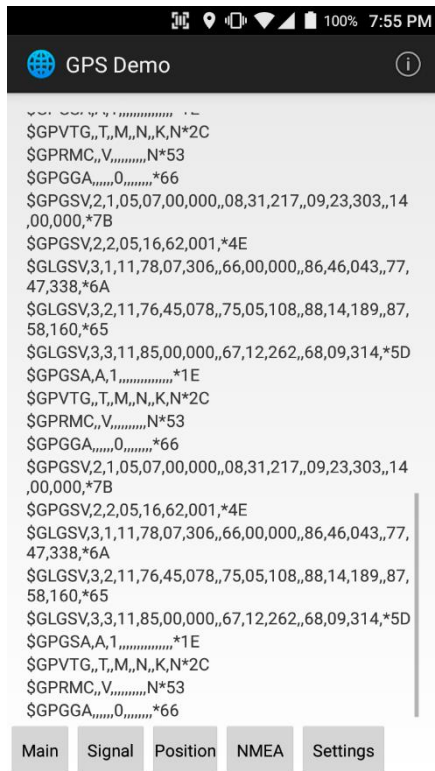

### GPS Demo

Developer can demonstrate or check Point Mobile Android model's GPS signal strength, Satellite info, NMEA info.

*Some of demo app only available for specific Hardware feature integrated SKU (Stock Keeping Unit)*

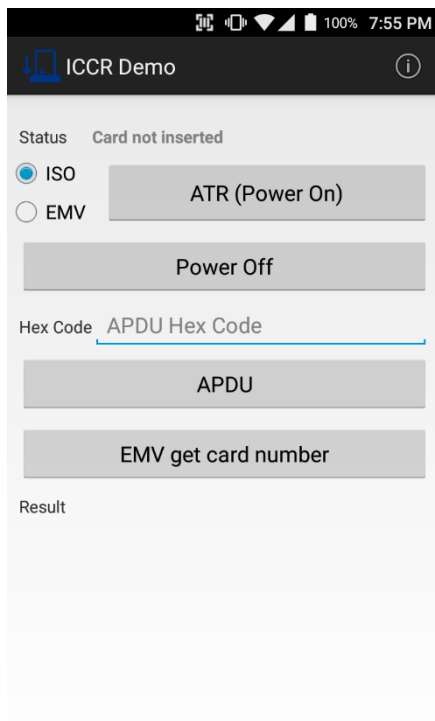

### ICCR Demo

Developer can demonstrate or check Point Mobile Android model's payment solution.

*Some of demo app only available for specific Hardware feature integrated SKU (Stock Keeping Unit)*

# EmKit Demos

## EmKit

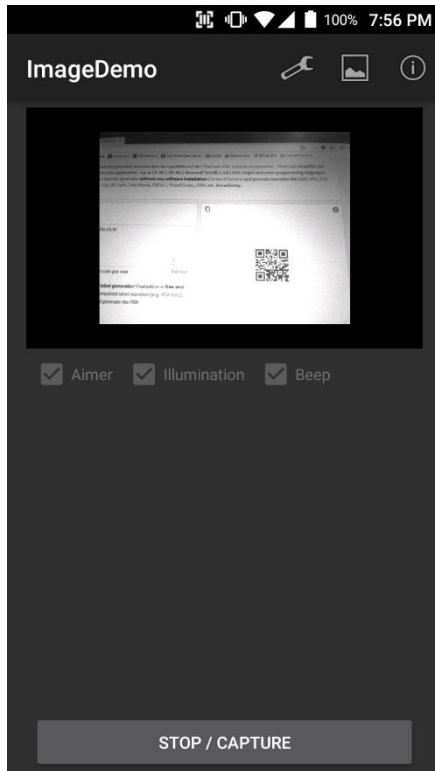

### Image Demo

Developer can demonstrate or check Point Mobile Android model's 2D scanner's image taking solution.

*Some of demo app only available for specific Hardware feature integrated SKU (Stock Keeping Unit)*

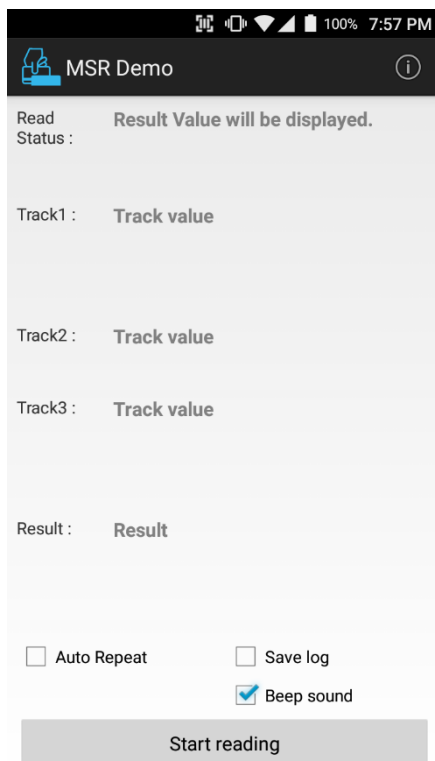

### MSR Demo

Developer can demonstrate or check Point Mobile Android model's IC card and Magnetic card reading solution.

*Some of demo app only available for specific Hardware feature integrated SKU (Stock Keeping Unit)*

# EmKit Demos

## EmKit

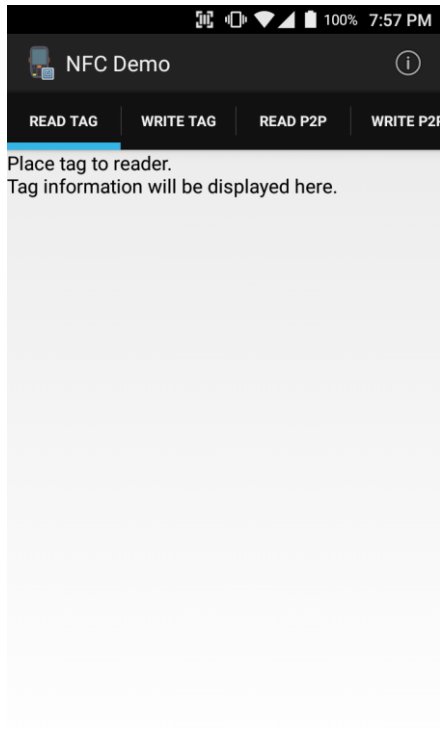

### NFC Demo

Developer can demonstrate or check Point Mobile Android model's NFC Read/Write solution.

*Some of demo app only available for specific Hardware feature integrated SKU (Stock Keeping Unit)*

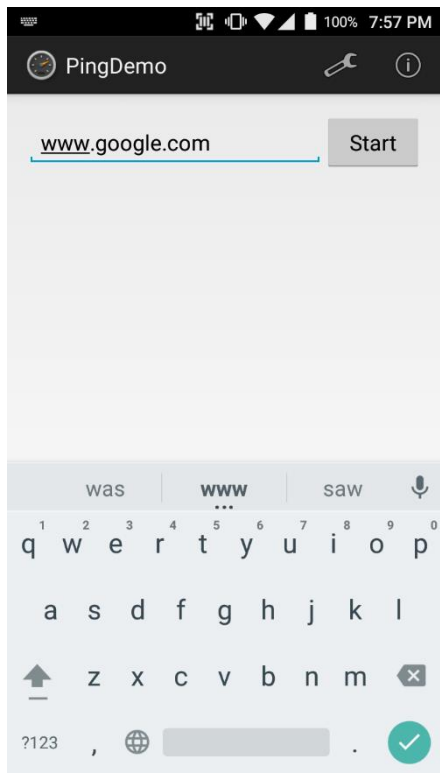

### Ping Demo

Developer can demonstrate or check Point Mobile Android model's ping test.



# EmKit Demos

## EmKit

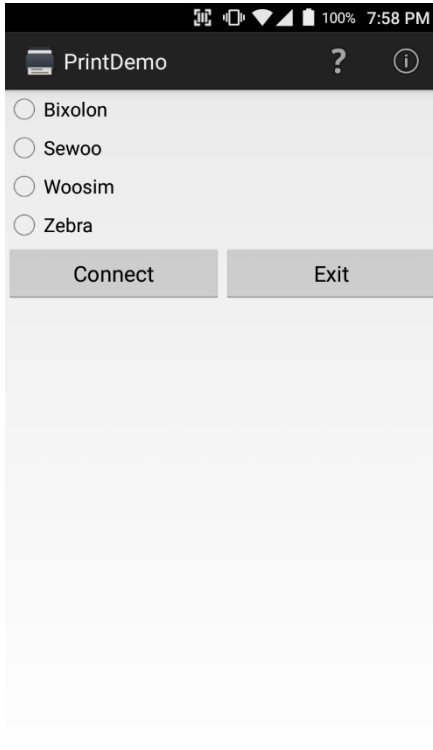

### Print Demo

Developer can demonstrate or check Point Mobile Android model's Bluetooth mobile printing solution.

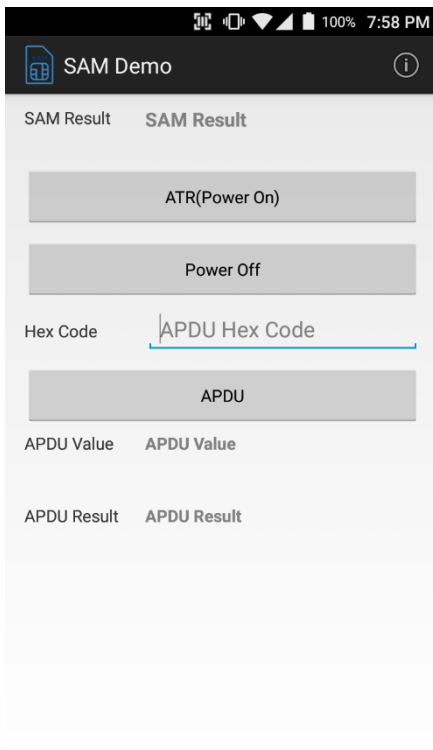

### SAM Demo

Developer can demonstrate or check Point Mobile Android model's SAM communication.

*Some of demo app only available for specific Hardware feature integrated SKU (Stock Keeping Unit)*

# EmKit Demos

## EmKit

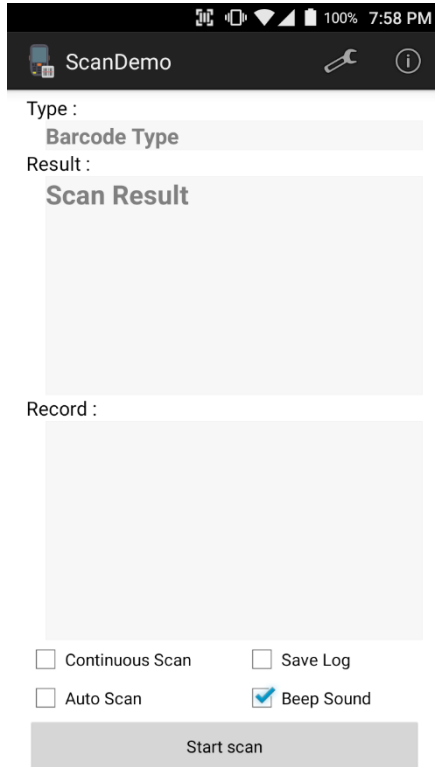

### Scan Demo

Developer can demonstrate or check Point Mobile Android model's Scanner solution.

*Some of demo app only available for specific Hardware feature integrated SKU (Stock Keeping Unit)*



## **POINT MOBILE. CO., LTD.**

### **Offline**

Tel: +82-2-3397-7870~1

ARS: 1800-3010

Fax: +82-2-3397-7872

Address: B-9F Kabul Great Valley, 32, Digital-ro 9-gil,  
Geumcheon-gu, Seoul, Korea 08512

### **Online**

Website: <http://www.pointmobile.co.kr/>

E-mail: [pm\\_support@pointmobile.co.kr](mailto:pm_support@pointmobile.co.kr)