

Gryphon™ I GD4500

General Purpose Coded
Handheld Area Imager Bar Code Reader



Product Reference Guide

Datalogic S.r.l.

Via S. Vitalino, 13
40012 Calderara di Reno (BO)
Italy
Tel. +39 051 3147011
Fax +39 051 3147205

©2011 - 2018 Datalogic S.p.A. and/or its affiliates

An Unpublished Work - All rights reserved. No part of the contents of this documentation or the procedures described therein may be reproduced or transmitted in any form or by any means without prior written permission of Datalogic S.r.l. or its subsidiaries or affiliates ("Datalogic" or "Datalogic S.r.l."). Owners of Datalogic products are hereby granted a non-exclusive, revocable license to reproduce and transmit this documentation for the purchaser's own internal business purposes. Purchaser shall not remove or alter any proprietary notices, including copyright notices, contained in this documentation and shall ensure that all notices appear on any reproductions of the documentation.

Should future revisions of this manual be published, you can acquire printed versions by contacting your Datalogic representative. Electronic versions may either be downloadable from the Datalogic website (www.datalogic.com) or provided on appropriate media. If you visit our website and would like to make comments or suggestions about this or other Datalogic publications, please let us know via the "Contact Datalogic" page

Disclaimer

Datalogic has taken reasonable measures to provide information in this manual that is complete and accurate, however, Datalogic reserves the right to change any specification at any time without prior notice.

Datalogic and the Datalogic logo are registered trademarks of Datalogic S.p.A. in many countries, including the U.S. and the E.U. Gryphon is a trademark of Datalogic S.p.A. and/or its affiliates, registered in the U.S. All other brand and product names may be trademarks of their respective owners.

Patents

See www.patents.datalogic.com for patent list.



Table of Contents

INTRODUCTION	1
About the Scanner	1
Using the GD4500 Reader	1
About this Manual	2
Overview	2
Manual Conventions	2
Technical Support	3
Datalogic Website Support	3
Reseller Technical Support	3
Telephone Technical Support	3
SETUP	5
Unpacking	5
Setting Up the Scanner	5
Connect Host Interface	6
Stand Installation	8
Hands-Free Stand/Holder	8
Using the Gryphon™ I GD4500	9
Interface Selection	11
Configuring the Interface	11
Customizing Configuration Settings	15
Using the Programming Bar Codes	15
Interface Settings	16
Configuring Other Features	16
Software Version Transmission	16
CONFIGURATION USING BAR CODES	19
Configuration Parameters	19
Global Interface Features	21
Host Commands — Obey/Ignore	21
USB Suspend Mode	21
RS-232 ONLY INTERFACE 23	
RS-232 Standard Factory Settings	23
Baud Rate	23
Data Bits	24
Stop Bits	25
Parity	25
Handshaking Control	26
RS-232/USB-COM INTERFACES 27	
Standard Factory Settings	27
Intercharacter Delay	28
Beep On ASCII BEL	29
Beep On Not on File	29
ACK NAK Options	30
ACK Character	31
NAK Character	31
ACK NAK Timeout Value	32
ACK NAK Retry Count	33
ACK NAK Error Handling	34
Indicate Transmission Failure	35
Disable Character	35
Enable Character	36
KEYBOARD INTERFACE 37	
Country Mode	38

Setup on PC to use ALT Universal	38
Setting Country Mode	39
Setting Encoding Type	53
Setting ALT output type	60
Caps Lock State	61
Numlock	61
Keyboard Numeric Keypad	62
Keyboard Send Control Characters	63
Wedge Quiet Interval	64
Intercharacter Delay	65
Intercode Delay	66
USB Keyboard Speed	67
USB-OEM INTERFACE 69	
Introduction	69
Standard Factory Settings	69
USB-OEM Device Usage	70
USB-OEM Interface Options	70
IBM 46XX INTERFACE 71	
46xx Number of Host Resets	72
Transmit Labels in code 39 Format	74
Interface Options	74
DATA FORMAT 75	
Global Prefix/Suffix	76
Global AIM ID	77
GS1-128 AIM ID	77
Label ID	78
Label ID: Pre-loaded Sets	78
Label ID: Set Individually Per Symbology	79
Label ID Control	79
Label ID Symbology Selection	80
Case Conversion	85
Character Conversion	86
READING PARAMETERS 87	
Double Read Timeout	88
Reading Performance	90
LED and Speaker Indicators	91
Power On Alert	91
Good Read: When to Indicate	92
Good Read Beep Type	93
Good Read Beep Frequency	93
Good Read Speaker Volume	94
Good Read Beep Length	95
Enable/Disable Good Read Indicator	96
.....	96
Scanning Features	97
Scan Mode	97
Flash On Time	98
Flash Off Time	99
Stand Mode Indication	100
Stand Mode Sensitivity	102
Stand Mode Illumination Off Time	103
Scanning Active Time	103
Stand Illumination Control	104
Motion Still Timeout	105
Pick Mode	106
Aiming Pointer	106
Aiming Duration Timer	107
Green Spot Duration	108
Mobile Phone Mode	109
Partial Label Reading Control	109
Decode Negative Image	110
Image Capture	110

Corded Stand Mode	111
Corded Stand Beep	112
Multiple Labels per Frame	113
Multiple Labels Ordering by Code Symbology	114
Multiple Labels Ordering by Code Length	114
1D SYMBOLOGIES 113	
Introduction	113
Standard Factory Settings for Symbologies	113
Disable All Symbologies	114
Coupon Control	114
UPC-A	115
UPC-A Enable/Disable	115
UPC-A Check Character Transmission	115
Expand UPC-A to EAN-13	116
UPC-A Number System Character Transmission	116
UPC-E	118
UPC-E Enable/Disable	118
UPC-E Check Character Transmission	118
Expand UPC-E to EAN-13	119
Expand UPC-E to UPC-A	119
UPC-E Number System Character Transmission	120
EAN 13	121
EAN 13 Enable/Disable	121
EAN 13 Check Character Transmission	121
EAN-13 Flag 1 Character	122
EAN-13 ISBN Conversion	122
ISSN Enable/Disable	123
EAN 8	124
EAN 8 Enable/Disable	124
EAN 8 Check Character Transmission	124
Expand EAN 8 to EAN 13	125
.....	125
UPC/EAN Global Settings	126
UPC/EAN Price Weight Check	126
Add-Ons	127
Optional Add-ons	127
Optional Add-On Timer	128
GS1 DataBar™ Omnidirectional	129
GS1 DataBar Omnidirectional Enable/Disable	129
GS1 DataBar Omnidirectional GS1-128 Emulation	130
GS1 DataBar™ Expanded	131
GS1 DataBar Expanded Enable/Disable	131
GS1 DataBar Expanded GS1-128 Emulation	131
GS1 DataBar Expanded Length Control	132
GS1 DataBar Expanded Set Length 1	132
GS1 DataBar Expanded Set Length 2	133
GS1 DataBar™ Limited	134
GS1 DataBar Limited Enable/Disable	134
GS1 DataBar Limited GS1-128 Emulation	134
Code 39	135
Code 39 Enable/Disable	135
Code 39 Check Character Calculation	135
Code 39 Check Character Transmission	136
Code 39 Start/Stop Character Transmission	137
Code 39 Full ASCII	137
Code 39 Quiet Zones	138
Code 39 Length Control	139
Code 39 Set Length 1	140
Code 39 Set Length 2	141
Code 32 (Italian Pharmaceutical)	142
Code 32 Enable/Disable	142
Code 32 Feature Setting Exceptions	142

Code 32 Check Character Transmission	142
Code 32 Start/Stop Character Transmission	143
Code 39 CIP (French Pharmaceutical)	143
Code 39 CIP Enable/Disable	143
Code 128	144
Code 128 Enable/Disable	144
Expand Code 128 to Code 39	144
Code 128 Check Character Transmission	145
Code 128 Function Character Transmission	145
Code 128 Quiet Zones	146
Code 128 Length Control	147
Code 128 Set Length 1	147
Code 128 Set Length 2	148
GS1-128	149
GS1-128 Enable	149
Interleaved 2 of 5 (I 2 of 5)	150
I 2 of 5 Enable/Disable	150
I 2 of 5 Check Character Calculation	151
I 2 of 5 Check Character Transmission	152
I 2 of 5 Length Control	152
I 2 of 5 Set Length 1	153
I 2 of 5 Set Length 2	154
Interleaved 2 of 5 CIP HR	155
Interleaved 2 of 5 CIP HR Enable/Disable	155
Datalogic 2 of 5	155
Datalogic 2 of 5 Enable/Disable	155
Datalogic 2 of 5 Check Character Calculation	156
Datalogic 2 of 5 Check Character Transmission	156
Datalogic 2 of 5 Length Control	157
Datalogic 2 of 5 Set Length 1	157
Datalogic 2 of 5 Set Length 2	158
Codabar	159
Codabar Enable/Disable	159
Codabar Check Character Calculation	159
Codabar Check Character Transmission	160
Codabar Start/Stop Character Transmission	160
Codabar Start/Stop Character Set	161
Codabar Start/Stop Character Match	161
Codabar Quiet Zones	162
Codabar Length Control	163
Codabar Set Length 1	163
Codabar Set Length 2	164
ABC Codabar	165
ABC Codabar Enable/Disable	165
ABC Codabar Concatenation Mode	165
ABC Codabar Dynamic Concatenation Timeout	166
ABC Codabar Force Concatenation	166
Code 11	167
Code 11 Enable/Disable	167
Code 11 Check Character Calculation	167
Code 11 Check Character Transmission	168
Code 11 Length Control	168
Code 11 Set Length 1	169
Code 11 Set Length 2	170
Standard 2 of 5	171
Standard 2 of 5 Enable/Disable	171
Standard 2 of 5 Check Character Calculation	171
Standard 2 of 5 Check Character Transmission	172
Standard 2 of 5 Length Control	172
Standard 2 of 5 Set Length 1	173
Standard 2 of 5 Set Length 2	174
Industrial 2 of 5	175

Industrial 2 of 5 Enable/Disable	175
Industrial 2 of 5 Check Character Calculation	175
Industrial 2 of 5 Check Character Transmission	176
Industrial 2 of 5 Length Control	176
Industrial 2 of 5 Set Length 1	177
Industrial 2 of 5 Set Length 2	178
IATA	179
IATA Enable/Disable	179
IATA Check Character Transmission	179
ISBT 128	180
ISBT 128 Concatenation	180
ISBT 128 Concatenation Mode	180
ISBT 128 Dynamic Concatenation Timeout	181
ISBT 128 Force Concatenation	182
ISBT 128 Advanced Concatenation Options	182
MSI	183
MSI Enable/Disable	183
MSI Check Character Calculation	183
MSI Check Character Transmission	184
MSI Length Control	184
MSI Set Length 1	185
MSI Set Length 2	186
Code 93	187
Code 93 Enable/Disable	187
Code 93 Check Character Calculation	187
Code 93 Check Character Transmission	188
Code 93 Length Control	188
Code 93 Set Length 1	189
Code 93 Set Length 2	190
Code 93 Quiet Zones	191
Follett 2 of 5	192
Follett 2 of 5 Enable/Disable	192
BC412	192
BC412 Enable/Disable	192
BC412 Check Character Calculation	193
BC412 Length Control	193
BC412 Set Length 1	194
BC412 Set Length 2	195
2D SYMBOLOGIES 201	
2D Global Features	201
2D Maximum Decoding Time	202
2D Structured Append	203
2D Normal/Inverse Symbol Control	203
SYMBOLOGY SELECTION 204	
Aztec Code	204
Aztec Code Enable / Disable	204
Aztec Code Length Control	204
China Sensible Code	207
China Sensible Code Enable / Disable	207
China Sensible Code Length Control	207
Data Matrix	210
Data Matrix Enable / Disable	210
Data Matrix Square/Rectangular Style	210
Data Matrix Length Control	211
Maxicode	213
Maxicode Enable / Disable	213
Maxicode Primary Message Transmission	213
Maxicode Length Control	214
PDF417	216
PDF417 Enable / Disable	216
PDF417 Length Control	216
Micro PDF417	219

Micro PDF417 Enable / Disable	219
Micro PDF417 Code 128 GS1-128 Emulation	219
Micro PDF417 Length Control	220
QR Code	222
QR Code Enable / Disable	222
QR Code Length Control	222
Micro QR Code	225
Micro QR Code Enable/Disable	225
Micro QR Code Length Control	225
UCC Composite	228
UCC Optional Composite Timer	228
Postal Code Selection	229
Postnet BB Control	230
MOTION FEATURES 231	
Motion Aiming Control	231
Motion Sensitivity	232
Motionless Timeout	233
REFERENCES.....	233
RS-232 Parameters	234
RS-232 Only	234
RS-232/USB COM Parameters	235
Keyboard Interface	242
Wedge Quiet Interval	242
Intercharacter Delay	243
Intercode Delay	244
Data Format	245
Data Editing	245
Global Prefix/Suffix	246
Global AIM ID	247
Label ID	248
Character Conversion	252
Scanning Features	253
Scan Mode	253
Scanning Active Time	254
Flash On Time	255
Flash Off Time	256
Symbolgies	257
Set Length	257
TECHNICAL SPECIFICATIONS.....	263
LED and Beeper Indications	266
Programming Mode	267
Troubleshooting	267
Standard Cable Pinouts	268
STANDARD DEFAULTS.....	269
Default Exceptions	277
SAMPLE BAR CODES	281
KEYPAD.....	285
SCANCODE TABLES.....	287
Control Character Emulation	287
Single Press and Release Keys	287
Interface Type PC AT PS/2 or USB-Keyboard	288
Interface Type PC AT PS/2 Alt Mode or USB-Keyboard Alt Mode	290
Microsoft Windows Codepage 1252	292



Chapter 1 Introduction

About the Scanner

With rich feature sets and extensive model options, the Gryphon™ product series from Datalogic represents the premium level of data collection equipment for general purpose applications. The Gryphon I GD45XX reader has enhanced Megapixel optics with improved motion tolerance, allowing codes placed on fast-moving objects to be easily and quickly captured, creating the ideal reader for tasks requiring high throughput like those found in retail, light industrial environments and healthcare.

Using the GD4500 Reader

To read a symbol or capture an image, simply aim the reader and pull the trigger. The Gryphon™ I GD45XX is a powerful omni-directional reader, so the orientation of the symbol is not important. Datalogic's exclusive patented 'Green Spot' for good-read feedback helps to improve productivity in noisy environments or in situations where silence is required. When positioning the product into the stand, the magnetic coupling will make the scanner automatically detect a bar code inside the field of view, and switch the reading system from trigger mode to autosense mode.

The Gryphon™ I GD45XX reliably decodes all standard 1D (linear) and 2D bar codes, including GS1 DataBar™ linear codes, Postal Codes (China Post), Stacked Codes (such as GS1 DataBar Expanded Stacked, GS1 DataBar Stacked, GS1 DataBar, Stacked Omnidirectional). The data stream – acquired from decoding a symbol – is rapidly sent to the host. The reader is immediately available to read another symbol.

Figure 1. Correct positioning of scanner

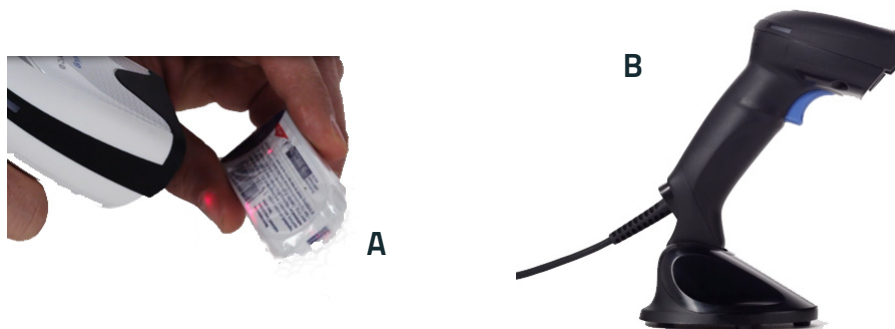

About this Manual

This Product Reference Guide (PRG) is provided for users seeking advanced technical information, including connection, programming, maintenance and specifications. The Quick Reference Guide (QRG) and other publications associated with this product are downloadable free of charge from the website listed on the back cover of this manual.

Typically, units are factory-programmed for the most common terminal and communications settings. If you need to modify any programmable settings, custom configuration can be accomplished by scanning the programming bar codes within this guide.

Programming can alternatively be performed using the Datalogic Aladdin™ Configuration application, which is available from the Datalogic website listed on the back cover of this manual. This multi-platform utility program allows device configuration using a PC. It communicates to the device using a serial or USB cable and can also create configuration bar codes to print.

Overview

[Chapter 1, Introduction](#) provides a product overview, unpacking instructions, and cable connection information.

[Chapter 2, Setup](#) presents information about unpacking and setting up the scanner, and interface configuration bar codes and details.

[Chapter 3, Configuration Using Bar Codes](#) provides instructions and bar code labels for customizing your scanner. There are different sections for interface types, general features, data formatting, and symbology-specific features.

[Chapter 4, References](#) provides details concerning programmable features.

[Appendix A, Technical Specifications](#) lists physical and performance characteristics, as well as environmental and regulatory specifications. It also provides standard cable pin-outs and descriptions of the functions and behaviors of the scanner's LED and Speaker indicators.

[Appendix B](#), references common factory default settings for scanner features and options.

[Appendix C, Sample Bar Codes](#) offers sample bar codes of several common symbologies.

[Appendix D, Keypad](#) includes numeric bar codes to be scanned for certain parameter settings.

[Appendix E, Scancode Tables](#) lists control character emulation information for Wedge and USB Keyboard interfaces.

Manual Conventions

The symbols listed below are used in this manual to notify the reader of key issues or procedures that must be observed when using the scanner:



NOTE

Notes contain information necessary for properly diagnosing, repairing and operating the scanner.



The CAUTION symbol advises you of actions that could damage equipment or property.

Technical Support

Datalogic Website Support

The Datalogic website (www.datalogic.com) is the complete source for technical support and information for Datalogic products. The site offers product support, warranty information, product manuals, product tech notes, software updates, demos, and instructions for returning products for repair.

Reseller Technical Support

An excellent source for technical assistance and information is an authorized Datalogic reseller. A reseller is acquainted with specific types of businesses, application software, and computer systems and can provide individualized assistance.

Telephone Technical Support

If you do not have internet or email access, you may contact Datalogic technical support at (541) 349-8283 or check the back cover of your manual for more contact information.

Current versions of the Product Reference Guide (PRG), Quick Reference Guide (QRG), the Datalogic Aladdin™ Configuration application, software/firmware and any additional manuals, instruction sheets and utilities for this product can be downloaded from the website listed on the back cover of this manual. Alternatively, printed copies or product support CDs may be purchased through your Datalogic reseller.

NOTES



Chapter 2 Setup

Unpacking

Check carefully to ensure the scanner and any cables or accessories ordered are present and undamaged. If any damage occurred during shipment, contact Technical Support on page 3.

KEEP THE PACKAGING. Should the unit ever require service, it should be returned in its original shipping container.

Setting Up the Scanner

Follow the steps provided in this section to connect and get your scanner up and communicating with its host:

1. Connect the Interface Cable at the scanner as shown in Figure 2. To disconnect the cable, insert a paper clip or similar object into the opening shown (item #3).
2. Connect the other end to the Host (see the next section, [Connect Host Interface](#) on page 6 and Figure 3).
3. Modify "[Customizing Configuration Settings](#)" on page 15 (only if modifications are needed from factory settings).

Figure 2. Cable Connection/Disconnection at the Scanner

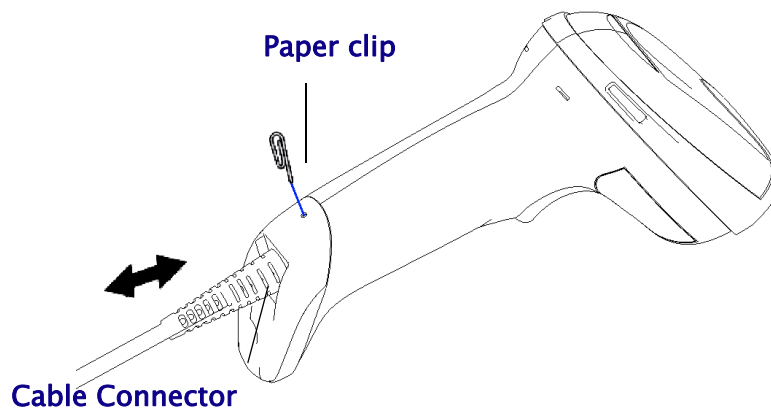

Connect Host Interface

The scanner kit you ordered to match your interface should provide a compatible cable for your installation. If this is not so, contact [Technical Support](#).

The scanner can communicate using the following interfaces:

RS-232 Serial Connection

Turn off power to the terminal/PC and connect the scanner to the terminal/PC serial port via the RS-232 cable as shown in Figure 3. If the terminal will not support POT (Power Off the Terminal) to supply scanner power, use the approved power supply (AC Adapter). Plug the AC Adapter barrel connector into the socket on the RS-232 cable connector and the AC Adapter plug into a standard power outlet.

RS-232: The scanner can communicate with a standard or Wincor-Nixdorf (W-N) RS-232 host.

RS-232 OPOS: This interface is used for OPOS/UPOS/JavaPOS systems.

Keyboard Wedge Connection

The Keyboard Wedge cable has a 'Y' connection from the scanner. Connect the female to the male end from the keyboard and the remaining end at the keyboard port at the terminal/PC.

Keyboard Wedge (KBW) : When connected using this interface, the host interprets scanned data as keystrokes and supports several international keyboards (for the Windows® environment). See "[Country Mode](#)" on page 38 for a full listing.

USB Connection

Connect the scanner to a USB port on the terminal/PC using the correct USB cable for the interface type you ordered.

USB : Select to communicate either by USB OEM, USB COM STD, or USB Keyboard interface types by scanning the appropriate interface type bar codes available in this manual. The default interface is USB-KBD, or RS-232-STD.

Figure 3. Connection to the Host

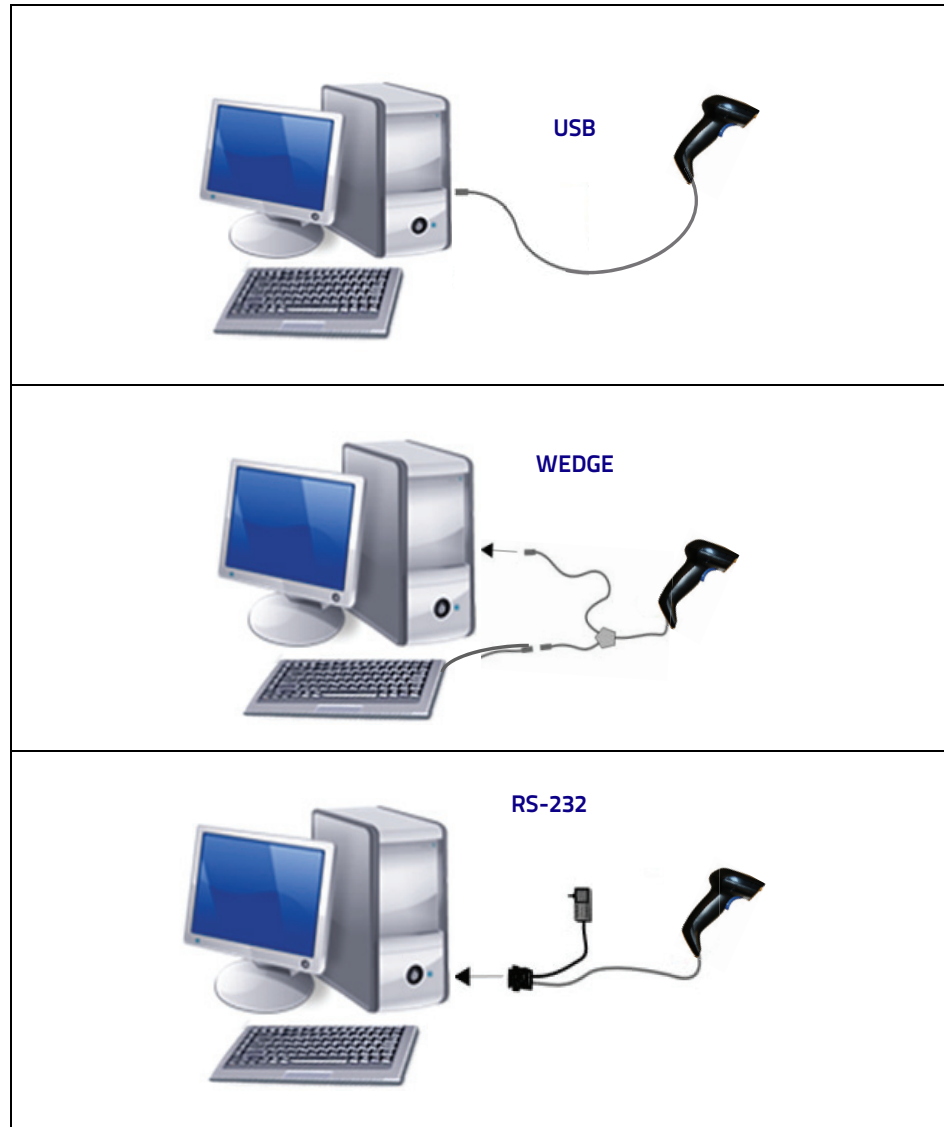

Specific cables are required for connection to different hosts. The connections illustrated in Figure 3 are examples only. Actual connectors may vary from those illustrated, but the steps to connect the scanner remain the same.

Stand Installation

Hands-Free Stand/Holder

An accessory is available which holds the reader (except those with integrated stand) at a convenient angle, allowing hands free scanning of items.

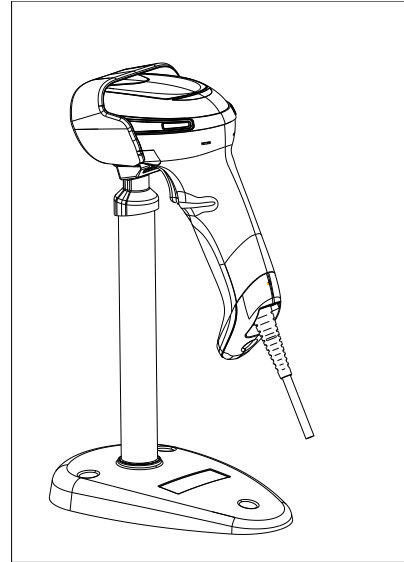
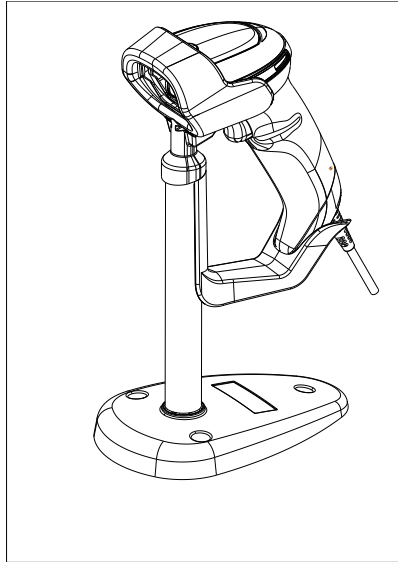

It can also be used as a holder. The holder “cup” can be positioned in any of the angles shown in the figure below. The reader automatically recognizes the insertion and changes its Scan Mode to allow the user to operate in hands-free mode.

Figure 4. Adjusting the Stand Arm

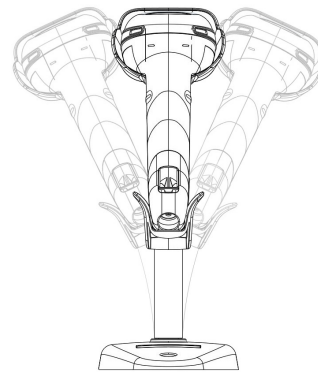
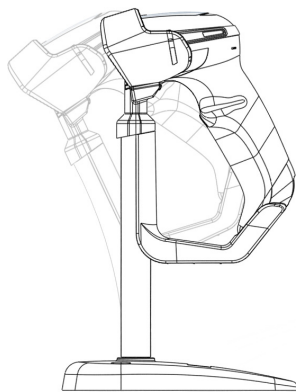

Using the Gryphon™ I GD4500

The Gryphon™ I GD4500 normally functions by capturing and decoding codes. The aiming system is activated on trigger pull and indicates the center of the field of view which should be positioned over the bar code:

Aiming System

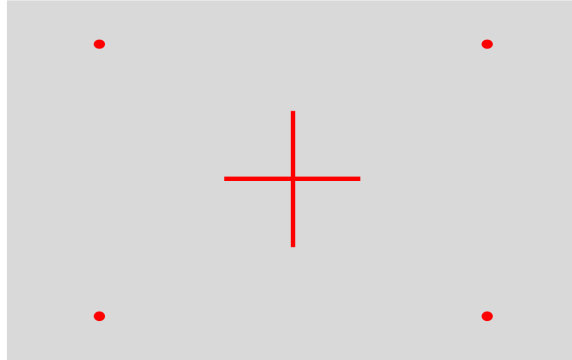

Relative Size and Location of Aiming System Pattern

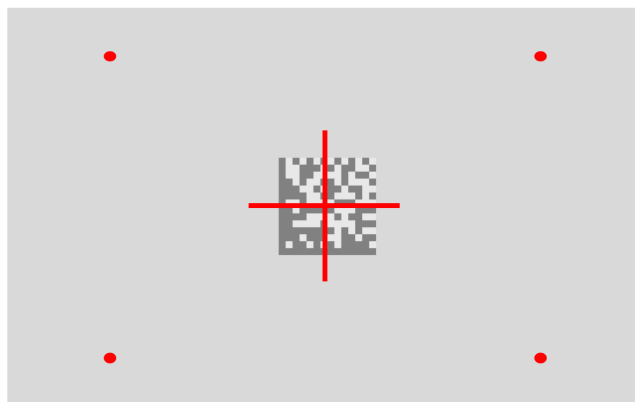

2D Matrix Symbol

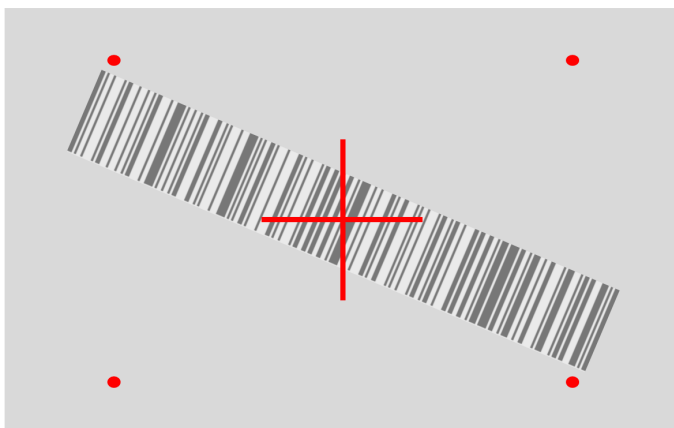

Linear Bar

A red beam illuminates the label. The field of view indicated by the aiming system will be smaller when the reader is closer to the bar code and larger when it is farther from the code. Symbologies with smaller bars or elements (mil size) should be read closer to the unit. Symbologies with larger bars or elements (mil size) should be read farther from the unit. If the aiming system is centered and the entire bar code is within the aiming field, you will get a good read. Successful reading is signaled by an audible tone plus a good-read green spot LED indicator.

Relative Size and Location of Green Spot

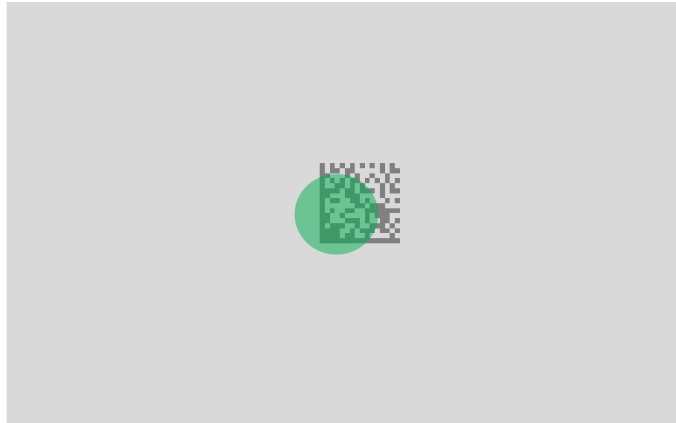

Interface Selection

Upon completing the physical connection between the scanner and its host, proceed directly to "[Configuring the Interface](#)" on page 11 for information and programming for the interface type the scanner is connected to (for example: RS-232, Keyboard Wedge, USB, etc.) and scan the appropriate bar code in that section to select your system's correct interface type.

The scanner, depending upon the model, will support one of the following sets of host interfaces:

- USB (Keyboard, COM, OEM)
- USB Composite (Keyboard + COM)
- USB HID POS
- USB Toshiba TEC
- RS-232 STD
- RS-232 WN
- RS232 OPOS
- Keyboard Wedge
- IBM46XX port 9b (a specific cable's required)
- Datalogic Magellan Scanners' specific interface

Configuring the Interface





Scan the programming bar code from the following section which selects the appropriate interface type to match the system the scanner will be connected to. Next, proceed to the corresponding chapter in this manual (also listed in the table) to configure any desired settings and features associated with that interface.



NOTE

Unlike some other programming features and options, interface selections require that you scan only one programming bar code label. **DO NOT** scan an ENTER/EXIT bar code prior to scanning an interface selection bar code. Some interfaces require the scanner to start in the disabled state when powered up. If additional scanner configuration is desired while in this state, pull the trigger and hold for 5 seconds. The scanner will change to a state that allows programming with bar codes.

Table 1. Available Interfaces

RS-232		FEATURES
RS-232 standard interface	 Select RS232-STD	
 Select RS232-WN	RS-232 Wincor-Nixdorf	
RS-232 for use with OPOS/UPOS/JavaPOS	 Select RS-232 OPOS	
 Select USB-COM-STD ^a	USB Com to simulate RS-232 standard interface	
USB-OEM		FEATURES
USB-OEM (can be used for OPOS/UPOS/JavaPOS)	 Select USB-OEM	Set USB-OEM Interface Features starting on page 69

a. Download the correct USB Com driver from www.datalogic.com

USB-COMPOSITE		FEATURES
<p>USB-Composite (combines USB-KBD emulation and USB-COM)</p>	 Select USB-Composite	
OTHER INTERFACES		
 Select IBM46xx Port 9b	<p>IBM46xx Port 9b</p>	
<p>USB HID POS</p>	 Select USB HID POS	
 Select USB Toshiba TEC	<p>USB Toshiba TEC</p>	
<p>Datalogic Magellan Scanners' specific interface</p>	 Select Datalogic Magellan Scanners' specific interface	

KEYBOARD	FEATURES
<p>AT, PS/2 25-286, 30-286, 50, 50Z, 60, 70, 80, 90 & 95 w/Standard Key Encoding</p>  <p>Select KBD-AT</p>	<p>Set KEYBOARD WEDGE Interface Features starting on page 37</p>
 <p>Select KBD-AT-NK</p> <p>Keyboard Wedge for IBM AT PS2 with standard key encoding but without external keyboard</p>	
<p>AT, PS/2 25-286, 30-286, 50, 50Z, 60, 70, 80, 90 & 95 w/Alternate Key</p>  <p>Select KBD-AT-ALT</p>	
 <p>Select KBD-AT-ALT-NK</p> <p>Keyboard Wedge for IBM AT PS2 with alternate key encoding but without external keyboard</p>	
<p>USB Keyboard with standard key encoding</p>  <p>Select USB Keyboard</p>	
 <p>Select USB Alternate Keyboard</p> <p>USB Keyboard with alternate key encoding</p>	

Customizing Configuration Settings

Using the Programming Bar Codes

This manual contains feature descriptions and bar codes which allow you to reconfigure your scanner. Some programming bar code labels, like "[Resetting the Product Configuration to Defaults](#)" on page 17, require only the scan of that single label to enact the change. Most of the programming labels in this manual, however, require the scanner to be placed in Programming Mode prior to scanning them. Scan an ENTER/EXIT bar code once to enter Programming Mode. Once the scanner is in Programming Mode, you can scan a number of parameter settings before scanning the ENTER/EXIT bar code a second time, which will then accept your changes, exit Programming Mode and return the scanner to normal operation.



NOTE

There are some exceptions to the typical programming sequence described above. Please read the description and setting instructions carefully when configuring each given programmable feature.

Datalogic Aladdin™ Utility

Programming can alternatively be performed using the Datalogic Aladdin™ Configuration application which is available for free download from the Datalogic website listed on the back cover of this manual. This multi-platform utility program allows device configuration using a PC. It communicates to the device using a serial or USB cable and can also create configuration bar codes to print. Datalogic Aladdin™ is a multi-platform utility program providing a quick and user-friendly configuration method via the RS-232/USB-COM interface. The Aladdin utility is available on the Datalogic website. Aladdin allows you to program the scanner by selecting configuration commands through a user-friendly graphical interface running on a PC. These commands are sent to the scanner over the selected communication interface, or they can be printed as bar codes to be scanned.

Aladdin also provides the ability to perform a software upgrade for the connected device (see the Datalogic Aladdin™ Help On-Line for more details).

Interface Settings

The scanner is typically factory-configured with a set of default features standard to the interface type you ordered. See "Interface Selection" on page 11.

[Global Interface Features, starting on page 21](#) provides settings configurable by all interface types. If your installation requires you to further customize your scanner, you can select other options through use of the instructions and programming bar codes available in the appropriate section for your interface.

- [RS-232 ONLY Interface, starting on page 23](#)
- [RS-232/USB-COM Interfaces, starting on page 27](#)
- RS232 OPOS
- USB Composite (COM + Keyboard)
- [Keyboard Interface, starting on page 37](#)
- [USB-OEM Interface, starting on page 69](#)

Configuring Other Features

If your installation requires different programming than the standard factory default settings, the following sections of this manual allow configuration of non-interface-specific settings you might require:

Configuration Using Bar Codes: General Features includes programming for scanning, speaker and LED indicators and other such universal settings.

Reading Parameters: Reading Parameters include programming for scanning, speaker and LED indicators and other universal settings.

1D Symbologies: Includes options concerning the bar code label types (symbologies). These settings allow you to enable/disable symbologies, set label lengths, require check digit, etc.

Software Version Transmission

The software version of the device can be transmitted over the RS-232, Keyboard and USB interfaces by scanning the following label.



Transmit Software Version

Resetting the Product Configuration to Defaults

If you aren't sure what programming options are in your scanner, or you've changed some options and want to restore the Custom Default Configuration that may have been saved in the scanner, scan the [Restore Custom Default Configuration](#) bar code below. This will restore the custom configuration for the currently active interface.



NOTE

Custom defaults are based on the interface type. Configure the scanner for the correct interface before scanning this label.



Restore Custom Default Configuration

NOTES



Chapter 3

Configuration Using Bar Codes

This and following sections provide programming bar codes to configure your scanner by changing the default settings. For details about additional methods of programming, see "Customizing Configuration Settings" on page 15.



NOTE

You must first enable your scanner to read bar codes in order to use this section. If you have not done this, go to Setup, starting on page 5 and complete the appropriate procedure.

Configuration Parameters

Once the scanner is set up, you can change the default parameters to meet your application needs. Refer to "Resetting the Product Configuration to Defaults" on page 17 for initial configuration in order to set the default values and select the interface for your application.

The following configuration parameters are divided into logical groups, making it easy to find the desired function based on its reference group.

Interface Configuration:

- "RS-232 ONLY Interface" on page 23
- "RS-232/USB-COM Interfaces" on page 27
- "Keyboard Interface" on page 37
- "USB-OEM Interface" on page 69

Parameters common to all interface applications:

- "Global Prefix/Suffix" on page 76
- "Data Format" on page 75 offers advanced configuration options for customization of scanned data output.
- "Reading Parameters" on page 87 control various operating modes and indicators status functioning.

Symbology-specific parameters:

"1D Symbologies" on page 113 defines options for all symbologies and provides the programming bar codes necessary for configuring these features.



NOTE

You must first enable your scanner to read bar codes in order to use this section. If you have not done this, go to Setup, starting on page 5 and complete the appropriate procedure.



To program features:

1. Scan the ENTER/EXIT PROGRAMMING bar code, available at the top of each programming page, when applicable.
2. Scan the bar code to set the desired programming feature. You may need to cover unused bar codes on the page, and possibly the facing page, to ensure that the scanner reads only the bar code you intend to scan.
3. If additional input parameters are needed, go to [Appendix D, Keypad](#), and scan the appropriate characters from the keypad.



NOTE

Additional information about many features can be found in the "References" chapter.

If you make a mistake before the last character, scan the CANCEL bar code to abort and not save the entry string. You can then start again at the beginning.

4. Complete the programming sequence by scanning the ENTER/EXIT PROGRAMMING bar code to exit Programming Mode.

For more detailed descriptions, programming information and examples for setting selected configuration items, see [References, starting on page 233](#).



Global Interface Features

The following interface features are configurable by all interface types. To set features specific to your interface, turn to that section of this manual.

HOST COMMANDS — OBEY/IGNORE on page 21
USB SUSPEND MODE on page 21

Host Commands — Obey/Ignore

This option specifies whether the scanner will obey or ignore host commands. When set to ignore, the scanner will ignore all host commands except for those necessary for:

- service mode
- flash programming mode
- keeping the interface active
- transmission of labels.

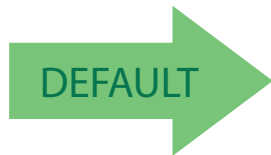

Host Commands = Obey



Host Commands = Ignore

USB Suspend Mode

This setting enables/disables the ability of the USB interface to enter suspend mode.



USB Suspend Mode = Enable



NOTES



RS-232 ONLY Interface

Use the programming bar codes in this chapter if modifications to the standard RS-232 interface settings are necessary to meet your system's requirements. Additional settings which apply to both the RS-232 and USB interfaces are available in [Chapter 5, RS-232/USB-COM Interfaces](#).

BAUD RATE on page 23	PARITY on page 25
DATA BITS on page 24	HANDSHAKING CONTROL on page 26
DATA BITS on page 24	

RS-232 Standard Factory Settings

Reference [Appendix B](#), for a listing of standard factory settings.

Baud Rate

Baud rate is the number of bits of data transmitted per second. Set the scanner's baud rate to match the baud rate setting of the host device. With an improper baud rate setting, data may not reach the host correctly.



Baud Rate = 1200



Baud Rate = 2400



Baud Rate = 4800



Baud Rate = 9600





Baud Rate (continued)



Baud Rate = 19,200



Baud Rate = 38,400



Baud Rate = 57,600



Baud Rate = 115,200

Data Bits

This parameter allows the reader to interface with devices requiring a 7-bit or 8-bit ASCII protocol for sending and receiving data.



7 Data Bits



8 Data Bits



Stop Bits

The stop bit(s) at the end of each transmitted character marks the end of transmission of one character and prepares the receiving device for the next character in the serial data stream. The number of stop bits selected (one or two) depends on the number the receiving terminal is programmed to accommodate. Set the number of stop bits to match host device requirements.

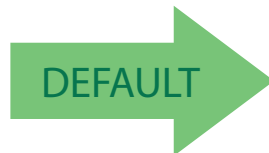

1 Stop Bit



2 Stop Bits

Parity

This feature specifies parity required for sending and receiving data. A parity check bit is the most significant bit of each ASCII coded character. Select the parity type according to host device requirements.

- Select None when no parity bit is required.
- Select Odd parity and the parity bit value is set to 0 or 1, based on data, to ensure that an odd number of 1 bits are contained in the coded character.
- Select Even parity and the parity bit value is set to 0 or 1, based on data, to ensure that an even number of 1 bits are contained in the coded character.

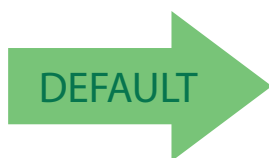

Parity = None



Parity = Even



Parity = Odd



Handshaking Control

The data interface consists of an RS-232 port designed to operate either with or without the hardware handshaking lines, Request to Send (RTS), and Clear to Send (CTS). Handshaking Control includes the following options:

- RTS — RTS is asserted during transmissions. CTS is ignored.
- RTS/CTS — RTS is asserted during transmissions. CTS gates transmissions.
- RTS/XON/XOFF — RTS is asserted during transmissions. CTS is ignored. XON and XOFF gate transmissions.
- RTS On/CTS — RTS is always asserted. CTS gates transmissions.
- RTS/CTS Scan Control — RTS is asserted during transmissions. CTS gates transmissions and controls enable and disable state of scanner.

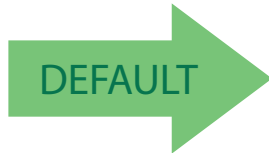

Handshaking Control = RTS



Handshaking Control = RTS/CTS



Handshaking Control = RTS/XON/XOFF



Handshaking Control = RTS On/CTS



Handshaking Control = RTS/CTS Scan Control



RS-232/USB-COM Interfaces

The programming bar codes in this chapter allow modifications to the standard RS-232 and USB-Com interfaces.

STANDARD FACTORY SETTINGS on page 27
INTERCHARACTER DELAY on page 28
BEEP ON ASCII BEL on page 29
BEEP ON NOT ON FILE on page 29
ACK NAK OPTIONS on page 30
ACK CHARACTER on page 31
NAK CHARACTER on page 31
ACK NAK TIMEOUT VALUE on page 32
ACK NAK RETRY COUNT on page 33
ACK NAK ERROR HANDLING on page 34
INDICATE TRANSMISSION FAILURE on page 35
DISABLE CHARACTER on page 35
ENABLE CHARACTER on page 36

Standard Factory Settings

Reference [Appendix B](#), for a listing of standard factory settings.



Intercharacter Delay

This parameter specifies the intercharacter delay between the end of one character and the beginning of the next. The delay can be set within a range of zero (0) to 990 milliseconds in 10ms increments. A setting of zero specifies no delay. See "Label ID: Pre-loaded Sets" on page 248 for more detailed programming instructions.



Intercharacter Delay = No Delay



Select Intercharacter Delay Setting

To configure this feature, scan the ENTER/EXIT bar code above, then the bar code at left followed by digits from the Alphanumeric characters in [Appendix D, Keypad](#) representing your desired character(s). End by scanning the ENTER/EXIT bar code again.

Make a mistake? Scan the CANCEL bar code to abort and not save the entry string. You can then start again at the beginning.

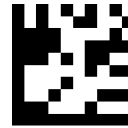

CANCEL

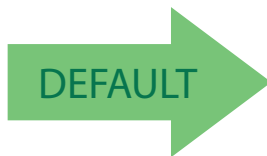

00 = No Intercharacter Delay



Beep On ASCII BEL

When this parameter is enabled, the scanner issues a beep when a <BEL> character is detected on the RS-232 serial line. <BEL> is issued to gain a user's attention to an illegal entry or other important event.



Beep On ASCII BEL = Disable



Beep On ASCII BEL = Enable

Beep On Not on File

This option enables/disables the action of the scanner to sound a three beep sequence upon receiving a Not-On-File (NOF) host command.



Beep On Not on File = Disable



Beep On Not on File = Enable



ACK NAK Options

This enables/disables the ability of the scanner to support the RS-232 ACK/NAK protocol. When configured, the scanner and/or host sends an “ACK” when it receives data properly, and sends “NAK” when the data is in error.

Options are:

- Disable
- Enable for label transmission — The scanner expects an ACK/NAK response from the host when a label is sent.
- Enable for host-command acknowledge — The scanner will respond with ACK/NAK when the host sends a command.
- Enable for label transmission and host-command acknowledge

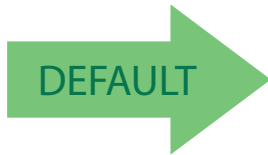

ACK/NAK Protocol = Disable ACK/NAK



ACK/NAK Protocol = Enable for label transmission



ACK/NAK Protocol = Enable for host-command acknowledge



ACK/NAK Protocol = Enable for label transmission and host-command acknowledge



ACK Character

This setting specifies an ASCII character or hex value to be used as the ACK character. ASCII characters or any hex value from 0 to 0xFF can be selected. See "ACK Character" on page 236 for more detailed programming instructions.



NOTE

Setting to previously defined characters such as XON, XOFF, or host commands conflicts with normal operation of these characters. 8-bit data is not recognized when the option Data Bits on page 24 has been set as 7 Data Bits.



Select ACK Character Setting

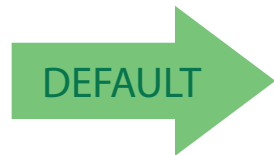

0x06 'ACK' Character

NAK Character

This setting specifies an ASCII character or hex value to be used as the NAK character. ASCII characters or any hex value from 0 to 0xFF can be selected. See "NAK Character" on page 237 for more detailed programming instructions.



NOTE

Setting to previously defined characters such as XON, XOFF, or host commands conflicts with normal operation of these characters. 8-bit data is not recognized when the option Data Bits on page 24 has been set as 7 Data Bits.



Select NAK Character Setting

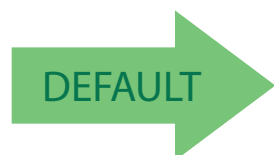

0x15 'NAK' Character



Make a mistake? Scan the CANCEL bar code to abort and not save the entry string. You can then start again at the beginning.

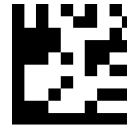

CANCEL

ACK NAK Timeout Value

This option specifies the amount of time the scanner waits for an ACK character from the host following label transmission. The selectable timeout range is 200 milliseconds to 15,000ms (15 seconds) in 200ms increments. A selection of 0 disables the timeout. See "ACK NAK Timeout Value" on page 238 for more detailed programming instructions.



Select ACK NAK Timeout Value Setting

To configure this feature, scan the ENTER/EXIT bar code above, then the bar code at left followed by digits from the Alphanumeric characters in [Appendix D, Keypad](#) representing your desired character(s). End by scanning the ENTER/EXIT bar code again.

Make a mistake? Scan the CANCEL bar code to abort and not save the entry string. You can then start again at the beginning.



CANCEL

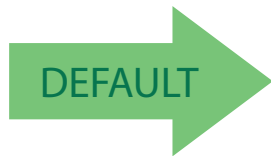

01 ACK NAK Timeout value is 200ms



ACK NAK Retry Count

This feature specifies the number of times the scanner retries a label transmission due to a retry condition. The selectable range is from 1 to 254 retries. A selection of 0 disables the count, and a selection of 255 specifies unlimited retries. See "ACK NAK Retry Count" on page 239 for more detailed programming instructions.



Select ACK NAK Retry Count Setting

To configure this feature, scan the ENTER/EXIT bar code above, then the bar code at left followed by digits from the Alphanumeric characters in [Appendix D, Keypad](#) representing your desired character(s). End by scanning the ENTER/EXIT bar code again.

Make a mistake? Scan the CANCEL bar code to abort and not save the entry string. You can then start again at the beginning.

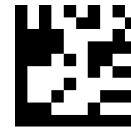

CANCEL

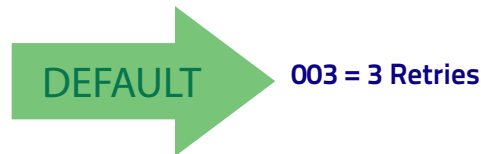



ACK NAK Error Handling

This feature specifies the method the scanner uses to handle receive errors detected while waiting for an ACK character from the host.

Options are:

- Ignore errors detected
- Process error as valid ACK character
- Process error as valid NAK character

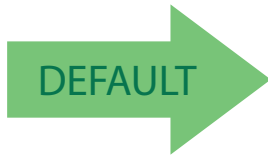

ACK NAK Error Handling = Ignore Errors Detected



ACK NAK Error Handling = Process Error
as Valid ACK Character



ACK NAK Error Handling = Process Error
as Valid NAK Character



Indicate Transmission Failure

This option enables/disables the scanner's ability to sound an error beep to indicate a transmission failure while in ACK/NAK mode.



Indicate Transmission Failure = Disable Indication



Indicate Transmission Failure = Enable Indication



Disable Character

Specifies the value of the RS-232 host command used to disable the scanner. ASCII characters or any hex value from 0 to 0xFF can be selected. See "Disable Character" on page 240 for more detailed programming instructions.



NOTE

Setting to previously defined characters such as XON, XOFF, or host commands conflicts with normal operation of these characters.



Select Disable Character Setting



0x44 = Disable Character is 'D'

Make a mistake? Scan the CANCEL bar code to abort and not save the entry string. You can then start again at the beginning.



CANCEL



Enable Character

Specifies the value of the RS-232 host command used to enable the scanner. ASCII characters or any hex value from 0 to 0xFF can be selected. See "Enable Character" on page 241 for more detailed programming instructions.



NOTE

Setting to previously defined characters such as XON, XOFF, or host commands conflicts with normal operation of these characters.



Select Enable Character Setting

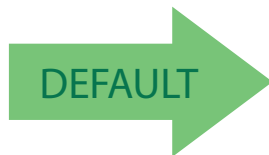

0x45 = Enable Character is 'E'

Make a mistake? Scan the CANCEL bar code to abort and not save the entry string. You can then start again at the beginning.



CANCEL

Keyboard Interface

Use the programming bar codes in this chapter to select options for USB Keyboard and Wedge Interfaces. Reference [Appendix B](#), for a listing of standard factory settings. Information about control character emulation which applies to keyboard interfaces is listed in [Appendix E, Scancode Tables](#).

COUNTRY MODE on page 38
CAPS LOCK STATE on page 61
NUMLOCK on page 61
KEYBOARD NUMERIC KEYPAD on page 62
KEYBOARD SEND CONTROL CHARACTERS on page 63
WEDGE QUIET INTERVAL on page 64
INTERCODE DELAY on page 66
USB KEYBOARD SPEED on page 67



Country Mode

This feature specifies the country/language supported by the keyboard. The Country Mode setting is ignored if the interface uses alternate key encoding.

Setup on PC to use ALT Universal

1. Open Registry Edit

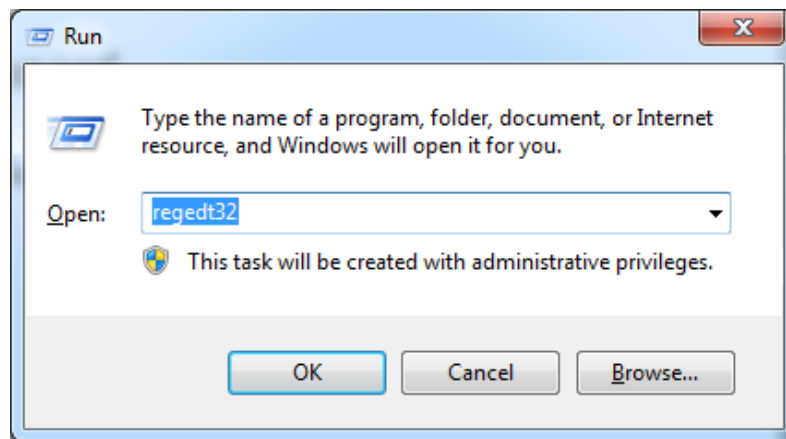

2. Set EnableHexNumpad to 1 as follows:

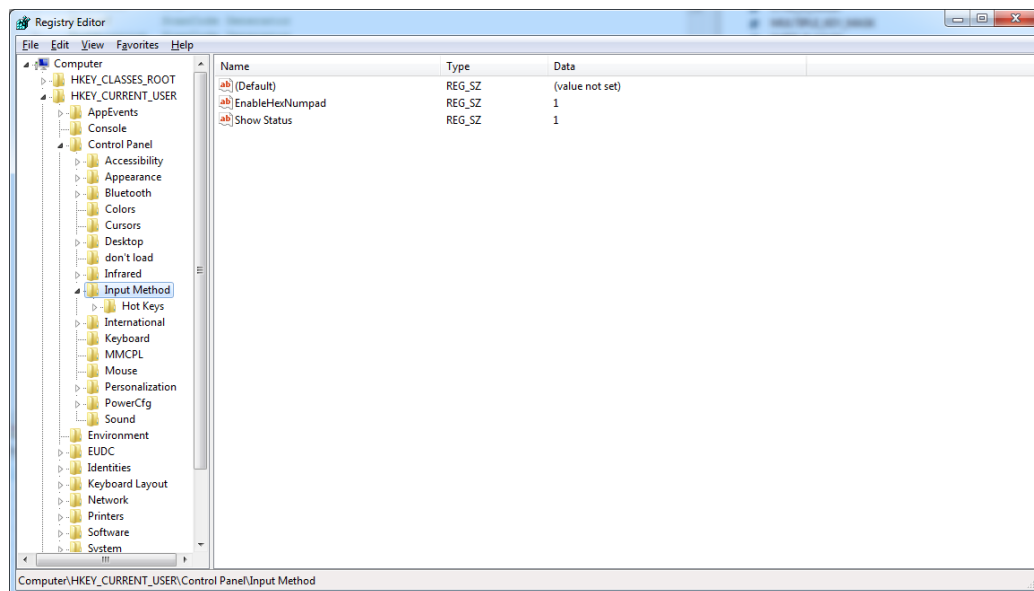

3. Reset the PC.



Setting Country Mode

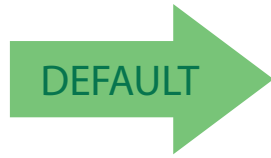

United States



French International (Belgian French)



United Kingdom



Danish



French (France)



German



Italian



Setting Country Mode (continued)



Norwegian



Portuguese Portugal



Spanish



Swedish



Swiss French



Japanese ASCII



Hungarian



Setting Country Mode (continued)



Slovak



Czech



Romanian



Croatian



Polish_214



Canadian French Win7



Lithuanian



Setting Country Mode (continued)



Vietnamese



Russian



Arabic 101



Chinese ASCII



Thai-Kedmanee



Albanian



Arabic 102



Setting Country Mode (continued)



Arabic 102 AZERTY



Azeri Cyrillic



Azeri Latin



Belarusian



Bosnian Cyrillic



Bosnian Latin



Bulgarian Cyrillic



Setting Country Mode (continued)



Bulgarian Latin



Canadian French (Legacy)



Canadian Multilingual



Chinese (Simplified)



Chinese (Traditional)



Czech Programmers



Czech QWERTY



Setting Country Mode (continued)



Dutch Netherland



Estonian



Faeroese



Finnish



French (Canada) 2000/XP



French (Canada) 95/98



Galician



Setting Country Mode (continued)



Greek



Greek Latin



Greek Polytonic



Greek220



Greek220 Latin



Greek319



Greek319 Latin



Setting Country Mode (continued)



Hebrew Israel



Hungarian_101KEY



Icelandic



Irish



Italian_142



Japanese (Shift-JIS)



Kazakh



Setting Country Mode (continued)



Korean (Hangul)



Korean ASCII



Kyrgyz Cyrillic



Latin America



Latvian

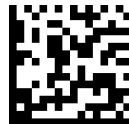

Latvian QWERTY



Lithuanian_IBM



Setting Country Mode (continued)



Macedonian -FYROM



Maltese_47KEY



Mongolian-Cyrillic



Polish Programmer



Portuguese Brazil



Portuguese Brazilian ABNT



Portuguese Brazilian ABNT2



Setting Country Mode (continued)



Romanian Legacy



Romanian Programmer



Romanian Standard



Russian Typewriter



Serbian Cyrillic



Serbian Latin



Slovak QWERTY



Setting Country Mode (continued)



Spanish Variation



Slovenian



Swiss German



Tatar



Turkish F



Turkish Q



Ukrainian



Setting Country Mode (continued)



US Dvorak



US Dvorak Left Hand



US Dvorak Right Hand



US English (Mac)



US English (North American)



US International



Uzbek Cyrillic



Setting Encoding Type

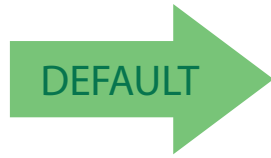

Don't use encoding



UTF_8



Windows 874



Windows 932



Windows 936



Windows 949



Windows 950



Setting Encoding Type (continued)



Windows 1250



Windows 1251



Windows 1252



Windows 1253



Windows 1254



Windows 1255



Windows 1256



Setting Encoding Type (continued)



Windows 1257



Windows 1258



Windows 20866



ISO 8859-1



ISO 8859-2



ISO 8859-3



ISO 8859-4



Setting Encoding Type (continued)



ISO 8859-5



ISO 8859-6



ISO 8859-7



ISO 8859-8



ISO 8859-9



ISO 8859-10



ISO 8859-11



Setting Encoding Type (continued)



ISO 8859-13



ISO 8859-14



ISO 8859-15



ISO 8859-16



MS-DOS 437



MS-DOS 737



MS-DOS 775



Setting Encoding Type (continued)



MS-DOS 850



MS-DOS 852

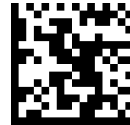

MS-DOS 855



MS-DOS 857



MS-DOS 860



MS-DOS 861



MS-DOS 862



Setting Encoding Type (continued)



MS-DOS 863



MS-DOS 865



MS-DOS 866



MS-DOS 869



Mac CP10000



Setting ALT output type

This option specifies the encode type of ALT Mode when the scanner sends Output Keyboard Data in Alt Mode. (Be aware that the scanner may switch automatically between ALT mode & Normal Keyboard Scancode, to correctly display some characters that are not present in the current Keyboard Country).

.



ALT Codepage: (use on non Unicode application: Notepad)



ALT Unicode: (use on Unicode application: Word)



ALT Universal: (Use for all)

Caps Lock State

This option specifies the format in which the scanner sends character data. This applies to Keyboard Wedge interfaces. This does not apply when an alternate key encoding keyboard is selected. This does not apply to USB Keyboard.

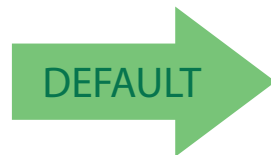

Caps Lock State = Caps Lock OFF



Caps Lock State = Caps Lock ON



Caps Lock State = AUTO Caps Lock Enable

Numlock

This option specifies the setting of the Numbers Lock (Numlock) key while in Keyboard Wedge interface. This only applies to alternate key encoding interfaces. It does not apply to USB Keyboard.

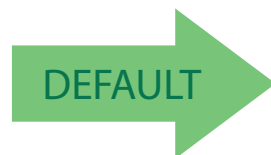

Numlock = Numlock key unchanged



Numlock = Numlock key toggled



Keyboard Numeric Keypad

This feature specifies if numeric characters will be sent using the standard keys or the numeric keypad.

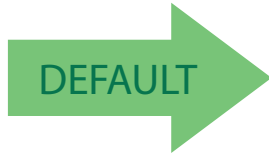

Keyboard Numeric Keypad = Standard Keys



Keyboard Numeric Keypad = Numeric Keypad



Keyboard Send Control Characters

This feature is used by the Keyboard Wedge and USB Keyboard interfaces. It specifies how the scanner transmits ASCII control characters to the host. Reference [Appendix E, Scancode Tables](#) for more information about control characters.

Options are as follows:

Send Ctrl+Key : ASCII characters from 00H to 0x1FH inclusive are transmitted in the format Ctrl+Key. Special keys are available in the range from 81H to A1.

Send Ctrl+Shift+Key : The behavior is the same as above, but control keys are sent in the format Ctrl+Shift+Keys.

Send Special Function Key : Send characters between 00H and 1FH according to the special function key mapping table (see "[Interface Type PC AT PS/2 Alt Mode or USB-Keyboard Alt Mode](#)" on page 290). This is used to send keys that are not in the normal ASCII set. A unique set is provided for each available scancode set.



Keyboard Send Control Characters = Send Ctrl+Key



Keyboard Send Control Characters = Send Ctrl+Shift+Key



Keyboard Send Control Characters = Send Special Function Key :



Wedge Quiet Interval

This option specifies the amount of time to look for keyboard activity before the scanner breaks the keyboard connection in order to transmit data to host. The selectable range for this feature is from 0 to 990ms in 10ms increments. See "Wedge Quiet Interval" on page 242 for more detailed programming instructions.



NOTE

This feature applies **ONLY** to the Keyboard Wedge interface.



Select Wedge Quiet Interval Setting

To configure this feature, scan the ENTER/EXIT bar code above, then the bar code at left followed by digits from the Alphanumeric characters in **Appendix D, Keypad** representing your desired character(s). End by scanning the ENTER/EXIT bar code again.

Make a mistake? Scan the CANCEL bar code to abort and not save the entry string. You can then start again at the beginning.

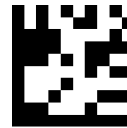

CANCEL

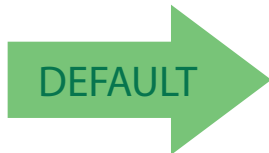

10 = Quiet Interval of 100 ms

Intercharacter Delay

This parameter specifies the intercharacter delay between the end of one character and the beginning of the next. The delay can be set within a range of zero (0) to 990 milliseconds in 10ms increments. A setting of zero specifies no delay. See "[Intercharacter Delay](#)" on page 243 for more detailed programming instructions.



Select Intercharacter Delay Setting

Make a mistake? Scan the CANCEL bar code to abort and not save the entry string. You can then start again at the beginning.



CANCEL



Intercharacter Delay = No Delay

To configure this feature, scan the ENTER/EXIT bar code above, then the bar code at left followed by digits from the Alphanumeric characters in [Appendix D, Keypad](#) representing your desired character(s). End by scanning the ENTER/EXIT bar code again.

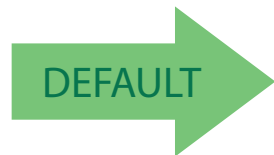

00 = No Intercharacter Delay



Intercode Delay

Specifies the delay between labels transmitted to the host for this interface. The selectable range for this feature is from 0 to 99 seconds. See "Intercode Delay" on page 244 for more detailed programming instructions.



Set Intercode Delay

To configure this feature, scan the ENTER/EXIT bar code above, then the bar code at left followed by digits from the Alphanumeric characters in [Appendix D, Keypad](#) representing your desired character(s). End by scanning the ENTER/EXIT bar code again.

Make a mistake? Scan the CANCEL bar code to abort and not save the entry string. You can then start again at the beginning.

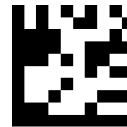

CANCEL

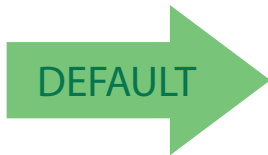

00 = No Wedge Intercode Delay

USB Keyboard Speed

This option specifies the USB poll rate for a USB Keyboard.



NOTE

This feature applies **ONLY** to the USB Keyboard interface.

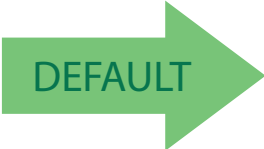

USB Keyboard Speed = 1ms



USB Keyboard Speed = 2ms



USB Keyboard Speed = 3ms



USB Keyboard Speed = 5ms



USB Keyboard Speed = 7ms



USB Keyboard Speed = 10ms

USB Keyboard Numeric Keypad

This option Controls whether numeric characters will be sent using standard keys or the numeric keypad.

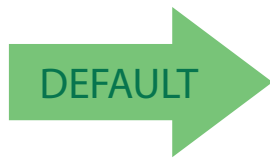

Standard Keys



Numeric Keypad

USB-OEM Interface

INTRODUCTION on page 69
STANDARD FACTORY SETTINGS on page 69
USB-OEM DEVICE USAGE on page 70
USB-OEM INTERFACE OPTIONS on page 70

Introduction

Feature settings for USB interfaces differ depending upon which host type the scanner will be connected with. Use the feature settings in this chapter to specifically configure for the USB-OEM interface. Other USB interfaces are included in the appropriate chapter for their host type.

Standard Factory Settings

Reference [Appendix B](#), for a listing of standard factory settings.



USB-OEM Device Usage

The USB-OEM protocol allows for the scanner to be identified as one of two different types of bar code scanners. Depending on what other scanners you may already have connected to a USB-OEM POS, you may need to change this setting to enable all devices to communicate.

Options are:

- Tabletop Scanner
- Handheld Scanner



NOTE

It may be necessary to switch device usage when connecting two scanners of the same type to a POS system.



USB-OEM Device Usage = Tabletop Scanner



USB-OEM Device Usage = Handheld Scanner



USB-OEM Interface Options

This setting provides for an interface specific control mechanism.

Options are:

- Obey — Obey Scanner Configuration Host Commands
- Ignore — Ignore Scanner Configuration Host Commands



USB-OEM Interface Options = Obey



USB-OEM Interface Options = Ignore



IBM 46XX Interface

Use the bar codes in this section to configure programmable features for available IBM 46XX interfaces.

Reference Appendix B, for a listing of standard factory settings..

46XX NUMBER OF HOST RESETS on page 72
TRANSMIT LABELS IN CODE 39 FORMAT on page 74
INTERFACE OPTIONS on page 74



46xx Number of Host Resets

Specifies how many consecutive resets are processed before the reader starts a five-second period to allow the user to enter Programming Mode and configure the reader. The configurable range for this feature is 1 to 15 resets.



46xx Number of Host Resets = 1



46xx Number of Host Resets = 2



46xx Number of Host Resets = 3



46xx Number of Host Resets = 4



46xx Number of Host Resets = 5



46xx Number of Host Resets = 6



46xx Number of Host Resets = 7

46xx Number of Host Resets - cont.



46xx Number of Host Resets = 8



46xx Number of Host Resets = 9



46xx Number of Host Resets = 10



46xx Number of Host Resets = 11



46xx Number of Host Resets = 12



46xx Number of Host Resets = 13



46xx Number of Host Resets = 14



46xx Number of Host Resets = 15



Transmit Labels in code 39 Format

This feature enable/disables translation to Code 39 before transmitting label data to an IBM-46XX or a USB-OEM host. Only the symbology identifier is modified for the translation. The data is not converted to Code 39 or verified to be valid for Code 39.

Options are:

IBM Standard Format: Send labels in standard IBM format.

Code 39 Format: Translate the following symbologies to Code 39:

- USB-OEM: Code128, Code 93, and Codabar
- IBM-Port 5B: Code 128, Code 93, and Codabar
- IBM-Port 9B: Code 93 and Codabar

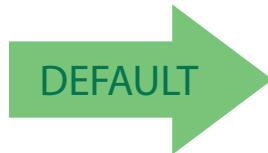

Transmit Labels in Code 39 Format = IBM Standard Format



Transmit Labels in Code 39 Format = Code 39 Format

Interface Options

This feature provides for an interface-specific control mechanism.



Obey Scanner Configuration Host Commands



Ignore Scanner Configuration Host Commands



Data Format

GLOBAL PREFIX/SUFFIX on page 76
GLOBAL AIM ID on page 77
GS1-128 AIM ID on page 77
LABEL ID starting on page 78 <ul style="list-style-type: none">•Label ID: Pre-loaded Sets on page 78•Label ID: Set Individually Per Symbology on page 79•Label ID Control on page 79•Label ID Symbology Selection on page 80
CASE CONVERSION on page 85
CHARACTER CONVERSION on page 86

The features in this chapter can be used to build specific user-defined data into a message string. See "References" starting on page 233 for more detailed instructions on setting these features.



Global Prefix/Suffix

Up to 20 ASCII characters may be added as a prefix (in a position before the bar code data) and/or as a suffix (in a position following the bar code data). See "Global Prefix/Suffix" on page 246 for more detailed programming instructions.

To configure this feature, scan the ENTER/EXIT bar code above, then the bar code at left followed by digits from the Alphanumeric characters in [Appendix D, Keypad](#) representing your desired character(s). End by scanning the ENTER/EXIT bar code again.

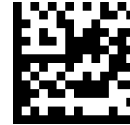

Set Global Prefix

To configure this feature, scan the ENTER/EXIT bar code above, then the bar code at left followed by digits from the Alphanumeric characters in [Appendix D, Keypad](#) representing your desired character(s). End by scanning the ENTER/EXIT bar code again.



Set Global Suffix

Make a mistake? Scan the CANCEL bar code to abort and not save the entry string. You can then start again at the beginning.

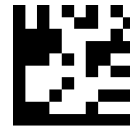

CANCEL

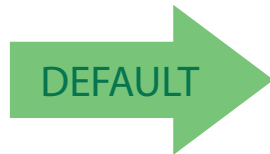

No Global Prefix
Global Suffix = 0x0D(CR)

Global AIM ID



This feature enables/disables addition of AIM IDs for all symbology types.

NOTE

AIM label identifiers (as opposed to custom characters you select yourself as with label identifiers) can be included with scanned bar code data. See "Global AIM ID" on page 247 for more detailed programming instructions.

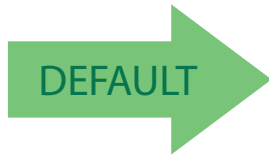

Global AIM ID = Disable



Global AIM ID = Enable

GS1-128 AIM ID

If Global AIM ID is disabled, the AIM ID for GS1-128 can be enabled/disabled independently. The AIM ID for GS1-128 is a]C1,]C2 or]C3. AIM IDs for other symbologies can be enabled/disabled independently as well. Contact Customer Support for assistance.



GS1-128 AIM ID = Disable



GS1-128 AIM ID = Enable





Label ID

A Label ID is a customizable code of up to three ASCII characters (each can be one of hex 0x01–0xFF), used to identify a bar code (symbology) type. It can be appended previous to or following the transmitted bar code data depending upon how this option is enabled. This feature provides options for configuring custom Label IDs as a pre-loaded set (see "Label ID: Pre-loaded Sets" on page 78) or individually per symbology (see "Label ID: Set Individually Per Symbology" on page 79). If you wish to program the scanner to always include an industry standard label identifier for ALL symbology types, see the previous feature "Global AIM ID" on page 77.

Label ID: Pre-loaded Sets

The scanner supports two pre-loaded sets of Label IDs, the USA set and the EU set. See "Label ID: Pre-loaded Sets" on page 248 for more information concerning the pre-loaded sets that are provided.



CAUTION

When changing from one Label ID set to another, all other scanner configuration settings, including the host interface type, will be erased and set to the factory defaults. Any custom configuration or custom defaults will be lost.



Label ID Pre-loaded Set = USA Set



Label ID Pre-loaded Set = EU Set



Label ID: Set Individually Per Symbology

This feature configures a Label ID individually for a single symbology.



NOTE

This setting requires the scanning of bar codes from multiple sections. See "Label ID: Set Individually Per Symbology" on page 250 for more detailed programming instructions.

Label ID Control

This option controls whether a Label ID is disabled, or sent as a prefix or suffix for a given symbology type.

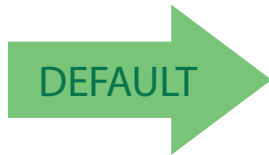

Label ID Transmission = Disable



Label ID Transmission = Enable as Prefix



Label ID Transmission = Enable as Suffix



Label ID Symbology Selection

This option selects the symbology for which a Label ID is to be configured. See "Label ID: Set Individually Per Symbology" on page 250 for full instructions.

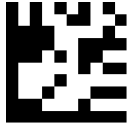

CANCEL

Make a mistake? Scan the CANCEL bar code to abort and not save the entry string. You can then start again at the beginning.



Set UPC-A Label ID Character(s)



Set UPC-A/P2 Label ID Character(s)



Set UPC-A/P5 Label ID Character(s)



Set UPC-E Label ID Character(s)



Set UPC-E/P2 Label ID Character(s)



Set UPC-E/P5 Label ID Character(s)



Label ID Symbology Selection (continued)

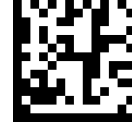

Set EAN 13 Label ID Character(s)



Set EAN 13/P2 Label ID Character(s)



Set EAN 13/P5 Label ID Character(s)



Set EAN 8 Label ID Character(s)



Set EAN 8/P2 Label ID Character(s)



Set EAN 8/P5 Label ID Character(s)



Label ID Symbology Selection (continued)



Set GS1 DataBar Omnidirectional Label ID Character(s)



Set GS1 DataBar Expanded Label ID Character(s)



Set GS1 DataBar Limited Label ID Character(s)



Set Code 39 Label ID Character(s)



Set Code 32 Label ID Character(s)



Set Code 39 CIP Label ID Character(s)



Label ID Symbology Selection (continued)



Set Code 128 Label ID Character(s)



Set GS1-128 Label ID Character(s)



Set Interleaved 2 of 5 Label ID Character(s)



Set Interleaved 2 of 5 CIP HR Label ID Character(s)



Set Datalogic 2 of 5 CIP HR Label ID Character(s)



Set Codabar Label ID Character(s)



Set ABC Codabar Label ID Character(s)



Label ID Symbology Selection (continued)



Set Code 11 Label ID Character(s)



Set Standard 2 of 5 Label ID Character(s)

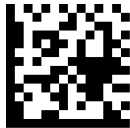

Set Industrial 2 of 5 Label ID Character(s)



Set ISSN Label ID Character(s)



Set IATA Label ID Character(s)



Set Concatenated ISBT 128 Label ID Character(s)



Set MSI Label ID Character(s)



Set Code 93 Label ID Character(s)

Label ID Symbology Selection (continued)



Set Follett 2 of 5 Label ID Character(s)

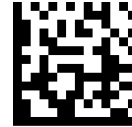

Set ISBN Label ID Character(s)



Set Concatenated ISBT Label ID Character(s)

Case Conversion

This feature allows conversion of the case of all alphabetic characters to upper or lower case.



NOTE

Case conversion affects **ONLY** scanned bar code data, and does not affect Label ID, Prefix, Suffix, or other appended data.

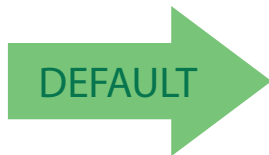

Case Conversion = Disable (no case conversion)



Case Conversion = Convert to upper case



Case Conversion = Convert to lower case



Character Conversion

Character conversion is an eight byte configuration item. The eight bytes are 4 character pairs represented in hexadecimal ASCII values. The first character in the pair is the character that will be converted. The second character in the pair is the character to convert to. If the character to convert in a pair is FF, then no conversion is done. See "Character Conversion" on page 252 for more detailed programming instructions.



Configure Character Conversion

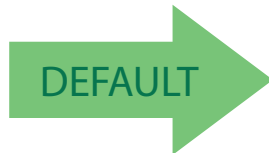

OxFFFFFFFFFFFFFFF
(No character conversion)

Make a mistake? Scan the CANCEL bar code to abort and not save the entry string. You can then start again at the beginning.



CANCEL

Reading Parameters

DOUBLE READ TIMEOUT on page 88	SCANNING FEATURES on page 97
LED AND SPEAKER INDICATORS on page 91	SCANNING FEATURES on page 97
POWER ON ALERT on page 91	SCANNING FEATURES on page 97
GOOD READ: WHEN TO INDICATE on page 92	SCAN MODE on page 97
GOOD READ: WHEN TO INDICATE on page 92	STAND MODE INDICATION on page 100
GOOD READ BEEP TYPE on page 93	STAND MODE INDICATION on page 100
GOOD READ BEEP FREQUENCY on page 93	FLASH ON TIME on page 98
GOOD READ SPEAKER VOLUME on page 94	FLASH OFF TIME on page 99
GOOD READ BEEP LENGTH on page 95	STAND MODE SENSITIVITY on page 102
ENABLE/DISABLE GOOD READ INDICATOR on page 96	PICK MODE on page 106



Double Read Timeout

To prevent a double read of the same label, the Double Read Timeout sets the minimum time allowed between reads of labels of the same symbology and data. If the unit reads a label and sees the same label again within the Double Read Timeout, the second read of the label will be ignored. Double Read Timeout does not apply to scan modes that require a trigger pull for each label that is read.



Double Read Timeout = 0.1 Second



Double Read Timeout = 0.2 Second



Double Read Timeout = 0.3 Second

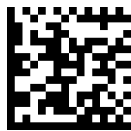

Double Read Timeout = 0.4 Second



Double Read Timeout (continued)



Double Read Timeout = 0.5 Second



Double Read Timeout = 0.6 Second



Double Read Timeout = 0.7 Second



Double Read Timeout = 0.8 Second



Double Read Timeout = 0.9 Second



Double Read Timeout = 1 Second



Reading Performance

When the barcode scanner's Scan Mode is set to triggerless modes (e.g. Flashing, Always On, Stand Mode, etc.) the reading capabilities can be modified according to two main goals:

- Motion tolerance: increased performance for rapidly moving barcodes.
- Depth of field: increased performance for distant barcodes.

Depending on specific environmental conditions or user's circumstances or expected performances, one may decide to assign a higher priority to one or the other.



Depth of field



Motion tolerance





LED and Speaker Indicators

Power On Alert

Disables or enables the indication (from the Speaker) that the scanner is receiving power.



Power On Alert = Disable (No Audible Indication)



Power On Alert = Power-up Beep





Good Read: When to Indicate

This feature specifies when the scanner will provide indication (beep and/or LED) upon successfully reading a bar code. Choices are:

- Good Read = Indicate after decode
- Good Read = Indicate after transmit
- Good Read = Indicate after CTS goes inactive, then active



NOTE

This option, which uses CTS, is only valid for RS-232 interfaces.

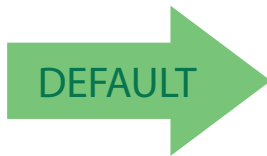

Indicate Good Read = After Decode



Indicate Good Read = After Transmit



Indicate Good Read = After CTS Goes Inactive, Then Active



Good Read Beep Type

Specifies whether the good read beep has a mono or bitonal beep sound.



Good Read Beep Type = Mono



Good Read Beep Type = Bitonal

Good Read Beep Frequency

Adjusts the good read beep to sound at a selectable low, medium or high frequency, selectable from the list below. (Controls the speaker's pitch/tone.)



Good Read Beep Frequency = Low



Good Read Beep Frequency = Medium

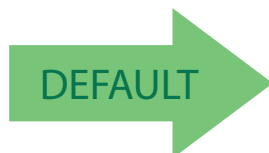

Good Read Beep Frequency = High



Good Read Speaker Volume

Selects the speaker volume (loudness) upon a good read beep. There are three selectable volume levels.



Good Read Speaker Volume = Speaker Off



Good Read Speaker Volume = Low



Good Read Speaker Volume = Medium



Good Read Speaker Volume = High





Good Read Beep Length

Specifies the duration of a good read beep.



Good Read Beep Length = 60 msec



Good Read Beep Length = 80 msec



Good Read Beep Length = 100 msec



Good Read Beep Length = 120 msec



Good Read Beep Length = 140 msec



Good Read Beep Length = 160 msec



Good Read Beep Length (continued)



Good Read Beep Length = 180 msec



Good Read Beep Length = 200 msec

Enable/Disable Good Read Indicator

Enable/Disable the good read indicator.



Good Read Indicator = Disable



Good Read Indicator = Enable





Scanning Features

Scan Mode

See "Scan Mode" on page 253 for more detailed programming instructions.



Scan Mode = Trigger Single



DEFAULT



Scan Mode = Trigger Hold Multiple



Scan Mode = Trigger Pulse Multiple



Scan Mode = Flashing



Scan Mode = Always On



Scan Mode = Stand Mode



Flash On Time

This feature specifies the ON time for the indicator LED while in Flash Mode. The selectable range is 100 to 9,900 milliseconds (0.1 to 9.9 seconds), in 100 millisecond increments. See "Flash On Time" on page 255 for more detailed programming instructions.

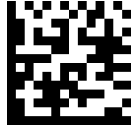

Select Flash ON Time Setting

To configure this feature, scan the ENTER/EXIT bar code above, then the bar code at left followed by digits from the Alphanumeric characters in [Appendix D, Keypad](#) representing your desired character(s). End by scanning the ENTER/EXIT bar code again.

Make a mistake? Scan the CANCEL bar code to abort and not save the entry string. You can then start again at the beginning.



CANCEL

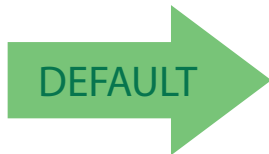

10 = Flash is ON for 1 Second



Flash Off Time

This feature specifies the OFF time for the indicator LED while in Flash Mode. The selectable range is 100 to 9,900 milliseconds (0.1 to 9.9 seconds), in 100 millisecond increments. See "Flash Off Time" on page 256 for more detailed programming instructions.



Select Flash OFF Time Setting

To configure this feature, scan the ENTER/EXIT bar code above, then the bar code at left followed by digits from the Alphanumeric characters in [Appendix D, Keypad](#) representing your desired character(s). End by scanning the ENTER/EXIT bar code again.

Make a mistake? Scan the CANCEL bar code to abort and not save the entry string. You can then start again at the beginning.



CANCEL

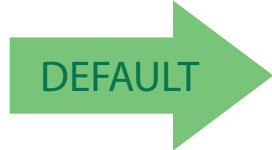

06 = Flash is OFF for 600ms



Stand Mode Indication

Enables/disables the LED flash when the reader is in Stand Mode.

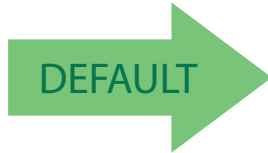

Stand Mode Flash = Disable



Stand Mode Flash = Enable



Stand Operation

Specifies the behavior of the reader when stationary in a stand. There are two conditions which cause the reader to switch to Stand Mode:

1. The reader is configured to switch to Stand Mode when stationary.
2. The reader is placed into the cradle of the base station.

Below are further options concerning Stand Operation.

Ignore Autorecognition. Disables mode switching when the reader is placed in a stand.

Switch to Stand Mode. Automatically switches the reader to Stand Mode when the reader is placed in the stand.

Switch to Flashing. Automatically switches the reader to Flash Mode when the reader is placed in the stand.

Switch to Always On. Automatically switches the reader to Always On mode when the reader is placed in the stand.





Stand Mode Sensitivity

Sets the sensitivity level for stand mode wakeup. Choices are low, medium and high.



Stand Mode Sensitivity = Low



Stand Mode Sensitivity = Medium



Stand Mode Sensitivity = High

Stand Mode Illumination Off Time

Specifies the amount of time reader illumination stays off after pulling the trigger when in Stand Mode. The configurable range is 01 to 32 by 01 in increments of 500ms (500ms to 16 seconds). See [page 287](#) in “References” for a description of this feature.



Select Stand Mode Time Setting

To configure this feature, scan the ENTER/EXIT PROGRAMMING MODE bar code above, then the bar code at left followed by the digits from the Alphanumeric characters in [Appendix D, Keypad](#) representing your desired character(s). End by scanning the ENTER/EXIT bar code again.

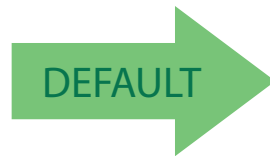

04 = 2 Seconds

Scanning Active Time

This setting specifies the amount of time that the reader stays in scan ON state once the state is entered. The range for this setting is from 1 to 255 seconds in 1-second increments. See [page 288](#) in “References” for further description of this feature.



Scanning Active Time = 3 seconds

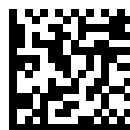

Scanning Active Time = 5 seconds



Scanning Active Time = 8 seconds

Stand Illumination Control

Controls the illumination status while the reading mode is stand mode and the reader is attempting to detect objects.

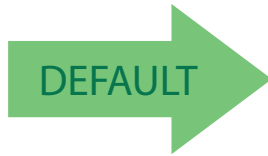

Stand Illumination Control = OFF



Stand Illumination Control = ON



Stand Illumination Control = Dim

Motion Still Timeout

Motion Still Timeout specifies the waiting time after which no motions is detected. When no motion is detected for period of time longer than the set Motion Still Timeout period, the scanner assumes it is in a motionless condition. The selectable setting are from 500 to 25,500 milliseconds in 100 millisecond increments. The default is 2 seconds. This option relates to such features and the Aimer On timing and Stand Mode Object Sense scanning with respect to motion.



Select Motion Still Timeout Setting

To configure this feature, scan the ENTER/EXIT PROGRAMMING MODE bar code above, then the bar code at left followed by the digits from the Alphanumeric characters in [Appendix D, Keypad](#) representing your desired character(s). End by scanning the ENTER/EXIT bar code again.

Make a mistake? Scan the CANCEL bar code to abort and not save the entry string. You can then start again at the beginning.

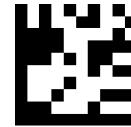

CANCEL

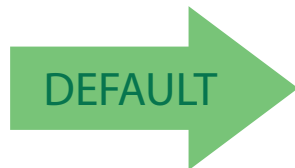

14 = Motion Still Timeout for 2 seconds

Pick Mode

Specifies the ability of the reader to decode labels only when they are close to the center of the aiming pattern. This allows the reader to accurately target labels when they are placed close together, such as on a pick sheet.

The Pick Mode can be enabled only in Trigger Single Scan Mode.



NOTE

This feature is not compatible with Multiple Labels Reading in a Volume.

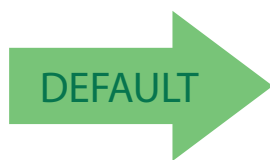

Pick Mode = Disable



Pick Mode = Enable

Aiming Pointer

Enables/disables the aiming pointer for all symbologies.



Aiming Pointer = Disable



Aiming Pointer = Enable



Aiming Duration Timer

Specifies the frame of time the aiming pointer remains on after decoding a label, when in trigger single mode. The range for this setting is from 1 to 255 seconds in 1-second increments. See [page 289](#) in “References” for a description of this feature.

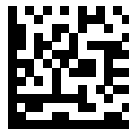
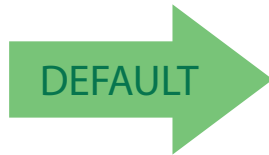

Set Aiming Duration Timer



Aiming Off After Decoding

To configure, scan the ENTER/EXIT PROGRAMMING MODE bar code above, then the bar code at left followed by the digits from the Alphanumeric characters in [Appendix D, Keypad](#) representing your desired character(s). End by scanning the ENTER/EXIT bar code.

Make a mistake? Scan the CANCEL bar code to abort and not save the entry string. You can then start again at the beginning.

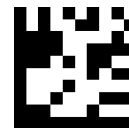

CANCEL

Green Spot Duration

Specifies the duration of the good read pointer beam after a good read.



Green Spot Duration = Disable (Green Spot is Off)



Green Spot Duration = Short (300 msec)



Green Spot Duration = Medium (500 msec)



Green Spot Duration = Long (800 msec)

Mobile Phone Mode

This mode is useful for scanning bar codes displayed on a mobile phone. Other options for this feature can be configured using the Datalogic Aladdin application.

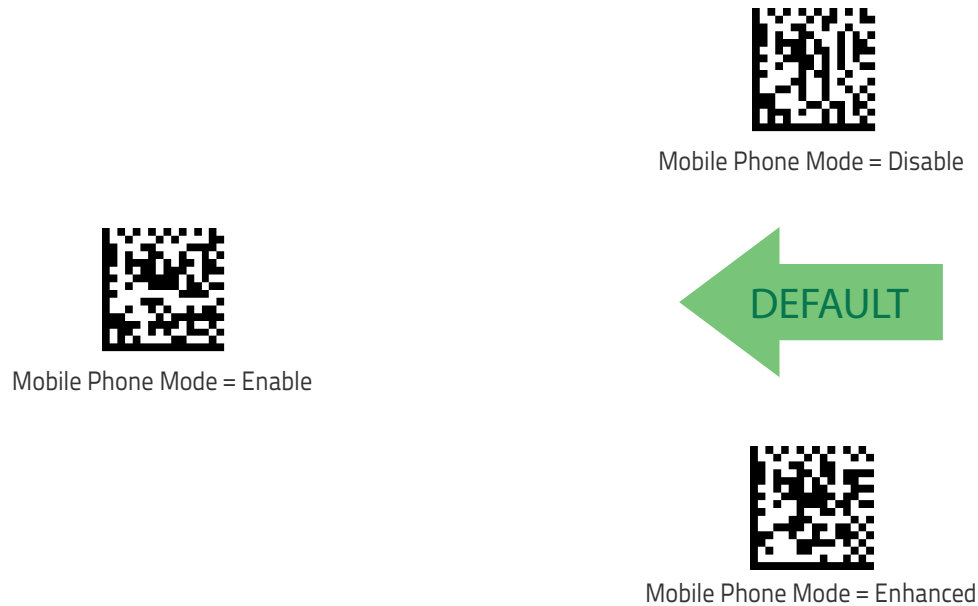

Partial Label Reading Control

Enable/Disable to ignore partial labels to be read within the boundary of the field of view.



Decode Negative Image

Enable/Disable the ability to decode a negative image for all symbologies. When this feature is enabled, you will be unable to read normally–printed labels or programming labels in this manual. Scan the “Disable” bar code below to return the scanner to its default for this feature. To set decoding for only 2D codes, go to ["2D Normal/Inverse Symbol Control" on page 209](#). For additional options, see the Aladdin configuration application.



Unlike some programming features and options, Decode Negative Image selections require that you scan only one programming bar code label. **DO NOT** scan an ENTER/EXIT bar code prior to scanning a Decode Negative Image bar code.



CAUTION

When this feature is enabled, you will be unable to read other programming labels in this manual.

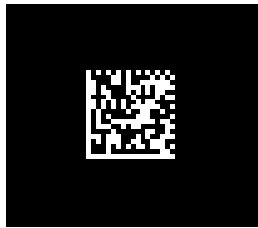

Decode Negative Image = Disable



Decode Negative Image = Enable

Image Capture

For information and a list of options for Image Capture, use the Datalogic Aladdin configuration application, available for free download from the Datalogic Scanning website.

CORDED ONLY FEATURES

Corded Stand Mode

Sets the Stand Mode Operation for Corded models



This feature is available starting with firmware release 610001013.

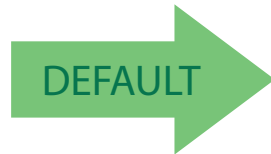

Corded Stand Mode = Disable



Corded Stand Mode = Generic Stand



Corded Stand Mode = for All-in-one and Base



Corded Stand Mode = Precise Stand

Corded Stand Beep

Enables/Disables the beep that indicates when Corded Stand position is detected.



This feature is available starting on firmware release 610001013.

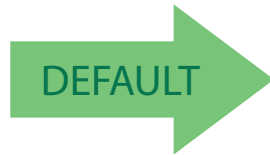

Corded Stand Beep = Disable

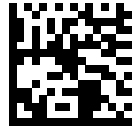

Corded Stand Beep = Enable

MULTIPLE LABEL READING

In standard (default) mode, when the reader's aiming system is activated (by a trigger pull, motion or other method depending on the mode), it then acquires and processes each image in the area in front of it (the Volume). In this case, the scanner stops processing the image once it decodes a label. If several labels are present in the volume, only the first label encountered is decoded and sent.

When Multiple Reading Mode is enabled, the scanner keeps on processing the image until all the labels present are decoded. The reader then sorts the data from all the bar codes (if configured to do so) before transmitting it.

Multiple Labels per Frame

Specifies the ability of the reader to decode and transmit a set of code labels in a specific volume and in a single frame of time. When in Multiple Labels per Frame the reader beeps and turns on the good read LED indication for each code read in a frame.

When Multiple Labels Mode is enabled, ISBT pairing, ABC Codabar pairing, and composites are not allowed.

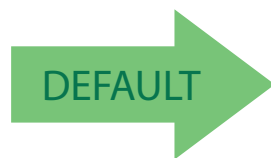

Multiple Labels per Frame = Disable



Multiple Labels per Frame = Enable

Multiple Labels Ordering by Code Symbology

This feature allows you to specify the order multiple labels are transmitted by symbology type, when Multiple Labels per Frame is enabled. See [page 292](#) in “References” for detailed information on setting this feature.



Select Symbologies for Multiple Labels Ordering

To configure this feature, scan the ENTER/EXIT PROGRAMMING MODE bar code above, then the bar code at left followed by the digits from the alphanumeric characters in Appendix d, keypad representing your desired Character(s), end by scanning the enter/exit bar code again.

Make a mistake? Scan the CANCEL bar code to abort and not save the entry string. You can then start again at the beginning.

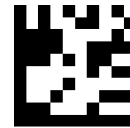

CANCEL

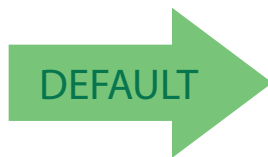

00000000000 = Random order

Multiple Labels Ordering by Code Length

Specifies the transmission ordering by code length, when Multiple Labels per Frame is enabled.

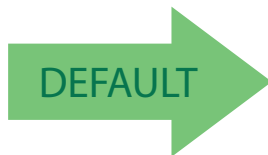

Multiple Labels Ordering = Disable



Transmit Increasing Length Order



Transmit Decreasing Length Order

1D Symbologies

Introduction

The scanner supports the following 1D symbologies (bar code types). Symbology-dependent options for each symbology are included in this chapter. See "2D Symbologies" starting on page 201 for configuration of 2D bar codes.

UPC-A on page 115	INTERLEAVED 2 OF 5 (I 2 OF 5) on page 150
UPC-E on page 118	INTERLEAVED 2 OF 5 CIP HR on page 155
EAN 13 on page 121	DATALOGIC 2 OF 5 on page 155
EAN 13 on page 121 (JAN 13)	CODABAR on page 159
EAN 8 on page 124 (JAN 8)	ABC CODABAR on page 165
ADD-ONS on page 127	CODE 11 on page 167
GS1 DATABAR™ OMNIDIRECTIONAL on page 129	STANDARD 2 OF 5 on page 171
GS1 DATABAR™ EXPANDED on page 131	INDUSTRIAL 2 OF 5 on page 175
GS1 DATABAR™ LIMITED on page 134	IATA on page 179
CODE 39 on page 135	ISBT 128 on page 180
CODE 32 (ITALIAN PHARMACEUTICAL) on page 142	MSI on page 183
CODE 39 CIP (FRENCH PHARMACEUTICAL) on page 143	CODE 93 on page 187
CODE 128 on page 144	FOLLETT 2 OF 5 on page 192
GS1-128 on page 149	BC412 on page 192

Standard Factory Settings for Symbologies

Default settings are indicated at each feature/option with a green arrow. Also reference [Appendix B](#), for a listing of the most widely used set of standard factory settings. That section also provides space to record any custom settings needed or implemented for your system.



Disable All Symbologies

Scan this label to disable all symbologies.

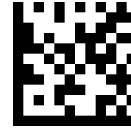

Disable all symbologies

Coupon Control

This feature is used to control the method of processing coupon labels.

Options are:

- Allow all — allow all coupon bar codes to be decoded
- Enable only UPC/EAN — enables only UPC/EAN coupon decoding
- Enable only GS1 DataBar — enables only GS1 DataBar coupon decoding

To set this feature:

1. Scan the Enter/Exit bar code.
2. Scan either the enable or disable bar code below. You'll need to cover any unused bar codes on this and the facing page to ensure that the scanner sees only the bar code you intend to scan.
3. Complete the programming sequence by scanning the Enter/Exit bar code.



Coupon Control = Allow all



Coupon Control = Enable only UPC/EAN



Coupon Control = Enable only GS1 DataBar

UPC-A

The following options apply to the UPC-A symbology.

UPC-A Enable/Disable

When disabled, the scanner will not read UPC-A bar codes.



UPC-A Check Character Transmission

Enable this option to transmit the check character along with UPC-A bar code data.





Expand UPC-A to EAN-13

Expands UPC-A data to the EAN-13 data format. Selecting this feature also changes the symbology ID to match those required for EAN-13.

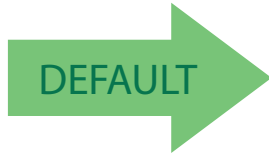

UPC-A to EAN-13 = Don't Expand



UPC-A to EAN-13 = Expand

UPC-A Number System Character Transmission

This feature enables/disables transmission of the UPC-A number system character.



UPC-A Number System Character = Do not transmit



UPC-A Number System Character = Transmit





UPC-A 2D Component

This feature enables/disables a requirement that a 2D label component be decoded when a base label of this symbology is decoded.

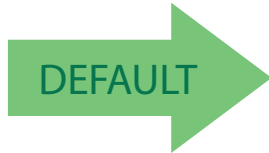

EAN-13 2D Component =
Disable (2D component not required)



EAN-13 2D Component =
2D component must be decoded



UPC-E

The following options apply to the UPC-E symbology.

UPC-E Enable/Disable

When disabled, the scanner will not read UPC-E bar codes.



UPC-E = Disable



UPC-E = Enable



UPC-E Check Character Transmission

Enable this option to transmit the check character along with UPC-E bar code data.



UPC-E Check Character Transmission = Don't Send



UPC-E Check Character Transmission = Send



Expand UPC-E to EAN-13

Expands UPC-E data to the EAN-13 data format. Selecting this feature also changes the symbology ID to match those required for EAN-13.

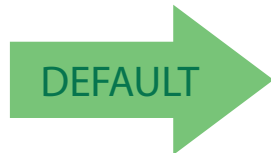

UPC-E to EAN-13 = Don't Expand



UPC-E to EAN-13 = Expand

Expand UPC-E to UPC-A

Expands UPC-E data to the UPC-A data format.



UPC-E to UPC-A = Don't Expand



UPC-E to UPC-A = Expand



UPC-E Number System Character Transmission

This feature enables/disables transmission of the UPC-E system number character.



UPC-E Number System Character = Do not transmit



UPC-E Number System Character = Transmit



EAN 13

The following options apply to the EAN 13 (Jan 13) symbology.

EAN 13 Enable/Disable

When disabled, the scanner will not read EAN 13/JAN 13 bar codes.



EAN 13 Check Character Transmission

Enable this option to transmit the check character along with EAN 13 bar code data.

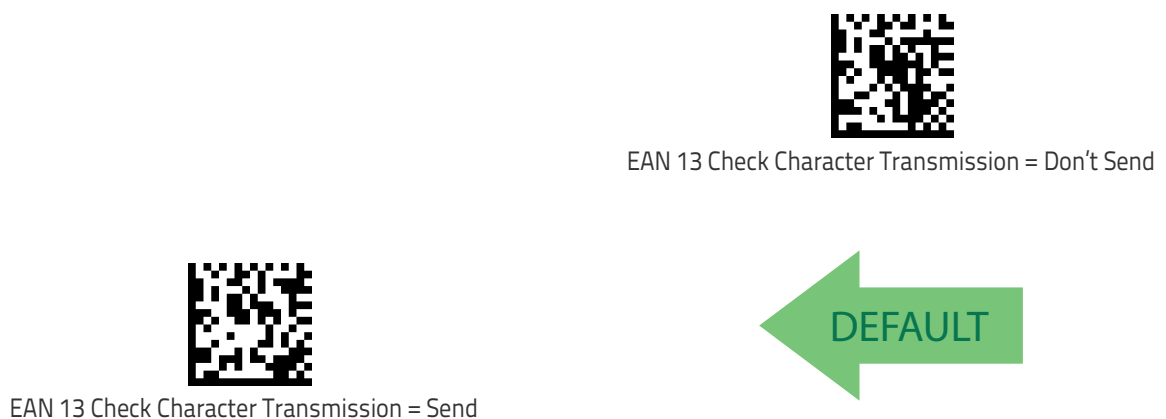



EAN-13 Flag 1 Character

Enables/disables transmission of an EAN/JAN13 Flag1 character. The Flag 1 character is the first character of the label.



EAN-13 Flag 1 Char= Don't transmit



EAN-13 Flag 1 Char= Transmit

EAN-13 ISBN Conversion

This option enables/disables conversion of EAN 13/JAN 13 Bookland labels starting with 978 to ISBN labels.

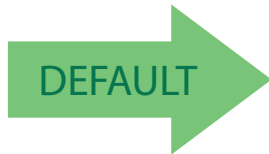

EAN-13 ISBN Conversion = Disable



EAN-13 ISBN Conversion = Convert to ISBN

EAN-13 2D Component

This feature enables/disables a requirement that a 2D label component be decoded when a base label of this symbology is decoded.

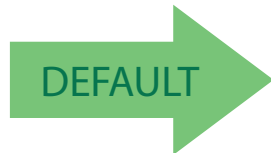

EAN-13 2D Component =
Disable (2D component not required)



EAN-13 2D Component =
2D component must be decoded

ISSN Enable/Disable

Enables/disables conversion of EAN/JAN 13 Bookland labels starting with 977 to ISSN labels.

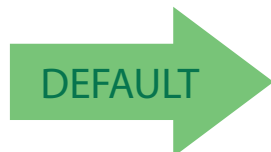

ISSN = Disable



ISSN = Enable



EAN 8

The following options apply to the EAN 8 (Jan 8) symbology.

EAN 8 Enable/Disable

When disabled, the scanner will not read EAN 8/JAN 8 bar codes.



EAN 8 = Disable



EAN 8 = Enable



EAN 8 Check Character Transmission

Enable this option to transmit the check character along with EAN 8 bar code data.



EAN 8 Check Character Transmission = Don't Send



EAN 8 Check Character Transmission = Send



Expand EAN 8 to EAN 13

Enable this option to expand EAN 8/JAN 8 labels to EAN 13/JAN 13.

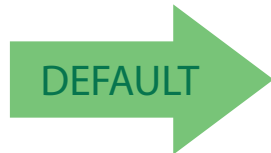

Expand EAN 8 to EAN 13 = Disable



Expand EAN 8 to EAN 13 = Enable

EAN 8 2D Component

This feature enables/disables a requirement that a 2D label component be decoded when a base label for this symbology is decoded.



EAN 8 2D Component =
Disable (2D component not required)



EAN 8 2D Component =
2D component must be decoded



UPC/EAN Global Settings

This section provides configuration settings for UPC-A, UPC-E, EAN 13 and EAN 8 symbologies, and affects all of these unless otherwise marked for each feature description.

UPC/EAN Price Weight Check

This feature enables/disables calculation and verification of price/weight check digits.

Options are

- Disabled
- Enable 4-digit price-weight check-digit calculation
- Enable 5-digit price-weight check-digit calculation
- Enable European 4-digit price-weight check-digit calculation
- Enable European 5-digit price-weight check-digit calculation

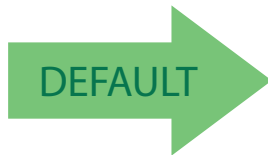

Price Weight Check = Disabled



Price Weight Check = 4-digit price-weight check



Price Weight Check = 5-digit price-weight check



Price Weight Check = European 4-digit price-weight check



Price Weight Check = European 5-digit price-weight check

Add-Ons

The following features apply to optional add-ons.



Contact Customer Support for advanced programming of optional and conditional add-ons.

NOTE

Optional Add-ons

The scanner can be enabled to optionally read the following add-ons (supplementals):

- P2
- P5



If a UPC/EAN base label and a an add-on are both decoded, the scanner will transmit the base label and add-on. If a UPC/EAN base label is decoded without an add-on, the base label will be transmitted without an add-on.

Conditional add-on settings (if enabled) are considered by the scanner before optional add-on settings.

NOTE

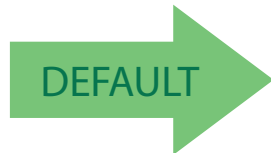

Optional Add-Ons = Disable P2



Optional Add-Ons = Enable P2

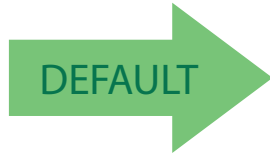

Optional Add-Ons = Disable P5



Optional Add-Ons = Enable P5

Optional Add-On Timer

This option sets the time the scanner will look for an add-on when an add-on fragment has been seen and optional add-ons are enabled.



Optional Add-on Timer = 10ms



Optional Add-on Timer = 20ms



Optional Add-on Timer = 30ms



Optional Add-on Timer = 50ms



Optional Add-on Timer = 70ms



DEFAULT



Optional Add-on Timer = 100ms



Optional Add-on Timer = 160ms

GS1 DataBar™ Omnidirectional

The following options apply to the GS1 DataBar Omnidirectional (formerly RSS-14) symbology.

GS1 DataBar Omnidirectional Enable/Disable

When disabled, the scanner will not read GS1 DataBar Omnidirectional bar codes.

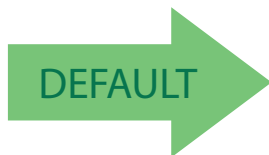

DEFAULT



GS1 DataBar Omnidirectional = Disable



GS1 DataBar Omnidirectional = Enable



GS1 DataBar Omnidirectional GS1-128 Emulation

When enabled, GS1 DataBar Omnidirectional bar codes will be translated to the GS1-128 label data format.

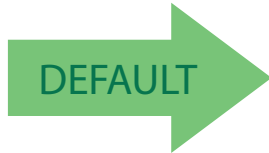

GS1 DataBar Omnidirectional GS1-128 Emulation = Disable



GS1 DataBar Omnidirectional GS1-128 Emulation = Enable

GS1 DataBar™ Omnidirectional 2D Component

This feature enables/disables a requirement that a 2D label component be decoded when a base label for this symbology is decoded.

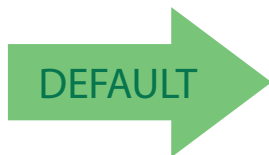

GS1 DataBar™ Omnidirectional 2D Component = Disable (2D component not required)



GS1 DataBar™ Omnidirectional 2D Component = 2D component must be decoded

GS1 DataBar™ Expanded

The following options apply to the GS1 DataBar Expanded (formerly RSS Expanded) symbology.

GS1 DataBar Expanded Enable/Disable

When disabled, the scanner will not read GS1 DataBar Expanded bar codes.

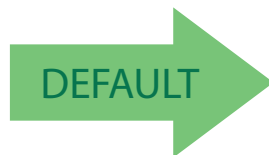

GS1 DataBar Expanded = Disable



GS1 DataBar Expanded = Enable

GS1 DataBar Expanded GS1-128 Emulation

When enabled, GS1 DataBar Expanded bar codes will be translated to the GS1-128 label data format.

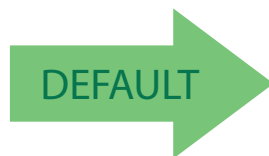

GS1 DataBar Expanded GS1-128 Emulation = Disable



GS1 DataBar Expanded GS1-128 Emulation = Enable



GS1 DataBar Expanded Length Control

This feature specifies either variable length decoding or fixed length decoding for the GS1 DataBar Expanded symbology.

Variable Length: For variable-length decoding, a minimum length may be set.

Fixed Length: For fixed-length decoding, two different lengths may be set.

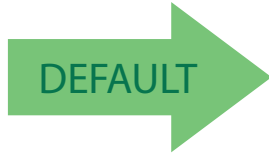

GS1 DataBar Expanded Length Control = Variable Length



GS1 DataBar Expanded Length Control = Fixed Length

GS1 DataBar Expanded Set Length 1

This feature specifies one of the bar code lengths for GS1 DataBar Expanded Length Control on page 132. Length 1 is the minimum label length if in Variable Length on page 132 Mode, or the first fixed length if in Fixed Length on page 132 Mode. Length includes the bar code's data characters only.

The length can be set from 1 to 74 characters. See "Set Length 1" on page 257 for more detailed programming instructions.



Select GS1 DataBar Expanded Set Length 1 Setting

To configure this feature, scan the ENTER/EXIT bar code above, then the bar code at left followed by digits from the Alphanumeric characters in **Appendix D, Key-pad** representing your desired character(s). End by scanning the ENTER/EXIT bar code again.

Make a mistake? Scan the CANCEL bar code to abort and not save the entry string. You can then start again at the beginning.



CANCEL

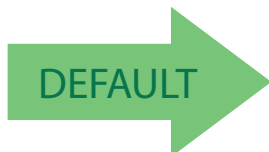

01 = Length 1 is 1 Character

GS1 DataBar Expanded Set Length 2

This feature specifies one of the bar code lengths for [GS1 DataBar Expanded Length Control on page 132](#). Length 2 is the maximum label length if in [Variable Length on page 132 Mode](#), or the second fixed length if in [Fixed Length on page 132 Mode](#). Length includes the bar code's data characters only.

The length can be set from 1 to 74 characters. A setting of 00 specifies to ignore this length (only one fixed length). See ["Set Length 2" on page 258](#) for more detailed programming instructions.



Select GS1 DataBar Expanded Set Length 2 Setting

To configure this feature, scan the ENTER/EXIT bar code above, then the bar code at left followed by digits from the Alphanumeric characters in [Appendix D, Keypad](#) representing your desired character(s). End by scanning the ENTER/EXIT bar code again.

Make a mistake? Scan the CANCEL bar code to abort and not save the entry string. You can then start again at the beginning.

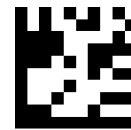

CANCEL

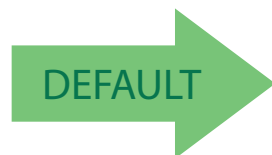

74 = Length 2 is 74 Characters



GS1 DataBar™ Limited

The following options apply to the GS1 DataBar Limited (formerly RSS Limited) symbology.

GS1 DataBar Limited Enable/Disable

When disabled, the scanner will not read GS1 DataBar Limited bar codes.

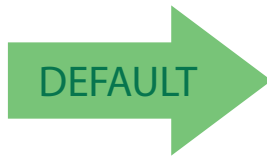

GS1 DataBar Limited = Disable



GS1 DataBar Limited = Enable

GS1 DataBar Limited GS1-128 Emulation

When enabled, GS1 DataBar Limited bar codes will be translated to the GS1-128 label data format.

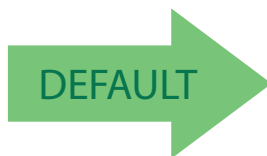

GS1 DataBar Limited GS1-128 Emulation = Disable



GS1 DataBar Limited GS1-128 Emulation = Enable

Code 39

The following options apply to the Code 39 symbology.

Code 39 Enable/Disable

When disabled, the scanner will not read Code 39 bar codes.



Code 39 Check Character Calculation

Enable this option to enable/disable calculation and verification of an optional Code 39 check character. When disabled, any check character in the label is treated as a data character.

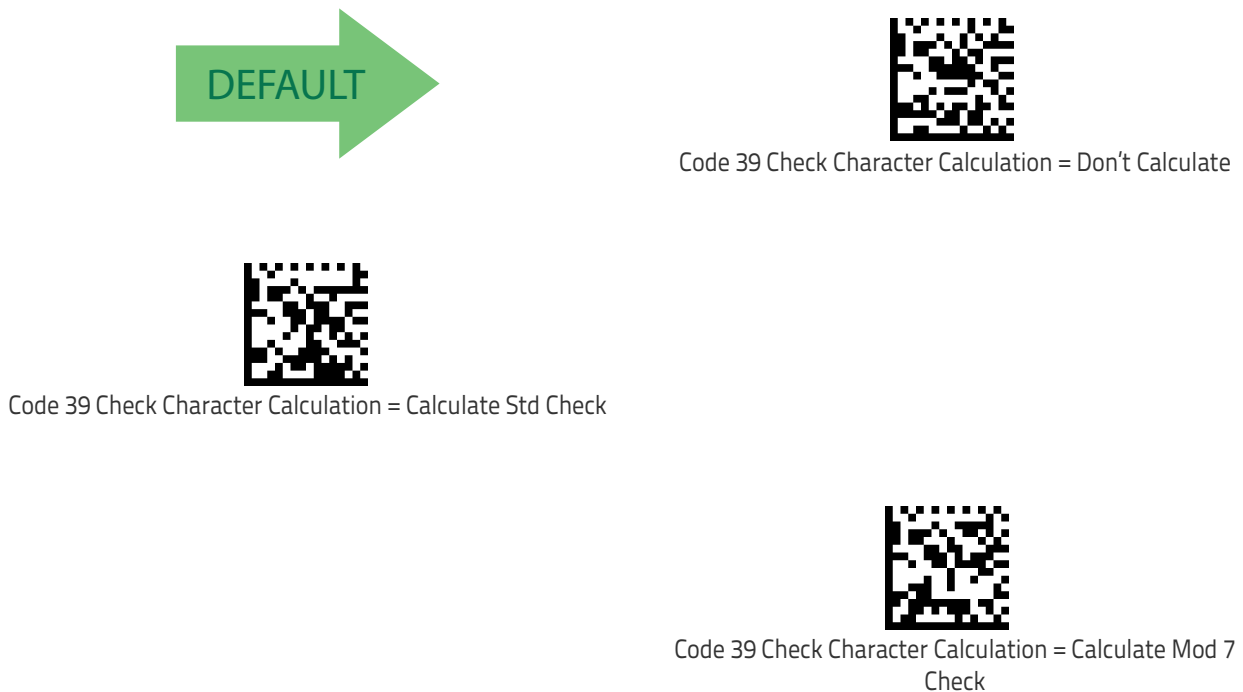



Code 39 Check Character Calculation (continued)



Code 39 Check Character Calculation = Enable Italian Post Check



Code 39 Check Character Calculation = Enable Daimler Chrysler Check

Code 39 Check Character Transmission

Enable this option to transmit the check character along with Code 39 bar code data.



Code 39 Check Character Transmission = Don't Send



Code 39 Check Character Transmission = Send



Code 39 Start/Stop Character Transmission

Enable this option to enable/disable transmission of Code 39 start and stop characters.

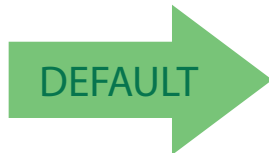

Code 39 Start/Stop Character Transmission = Don't Transmit



Code 39 Start/Stop Character Transmission = Transmit

Code 39 Full ASCII

In Code 39 decoding, this enables/disables the translation of Code 39 characters to Code 39 full-ASCII characters.

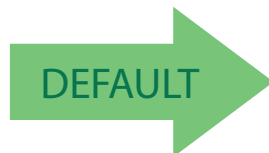

Code 39 Full ASCII = Disable



Code 39 Full ASCII = Enable



Code 39 Quiet Zones

This feature specifies the number of quiet zones for Code 39 labels. Quiet zones are blank areas at the ends of a bar code and are typically 10 times the width of the narrowest bar or space in the label.



Code 39 Quiet Zones = Quiet Zone on one side



Code 39 Quiet Zones = Quiet Zones on two sides



Code 39 Quiet Zones = Auto



Code 39 Quiet Zones = Virtual Quiet Zones on two sides



Code 39 Quiet Zones = Small Quiet Zones on two sides

Code 39 Length Control

This feature specifies either variable length decoding or fixed length decoding for the Code 39 symbology.

Variable Length: For variable length decoding, a minimum and maximum length may be set.

Fixed Length: For fixed length decoding, two different lengths may be set.

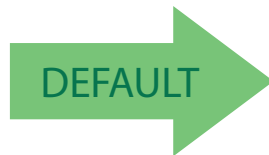

Code 39 Length Control = Variable Length



Code 39 Length Control = Fixed Length



Code 39 Set Length 1

This feature specifies one of the bar code lengths for [Code 39 Length Control on page 139](#). Length 1 is the minimum label length if in [Variable Length on page 139 Mode](#), or the first fixed length if in [Fixed Length on page 139 Mode](#). Length includes the bar code's check, data, and full-ASCII shift characters. The length does not include start/stop characters.

The length can be set from 0 to 50 characters. See "[Set Length 1](#)" on page 257 for more detailed programming instructions.



Select Code 39 Set Length 1 Setting

To configure this feature, scan the ENTER/EXIT bar code above, then the bar code at left followed by digits from the Alphanumeric characters in [Appendix D, Keypad](#) representing your desired character(s). End by scanning the ENTER/EXIT bar code again.

Make a mistake? Scan the CANCEL bar code to abort and not save the entry string. You can then start again at the beginning.

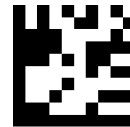

CANCEL

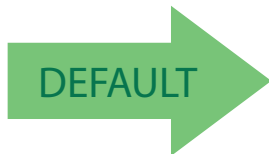

02 = Length 1 is 2 Characters

Code 39 Set Length 2

This feature specifies one of the bar code lengths for [Code 39 Length Control on page 139](#). Length 2 is the maximum label length if in [Variable Length on page 139 Mode](#), or the second fixed length if in [Fixed Length on page 139 Mode](#). Length includes the bar code's check, data, and full-ASCII shift characters. The length does not include start/stop characters.

The length can be set from 1 to 50 characters. A setting of 00 specifies to ignore this length (only one fixed length). See ["Set Length 2" on page 258](#) for more detailed programming instructions.



Select Code 39 Length 2 Setting

To configure this feature, scan the ENTER/EXIT bar code above, then the bar code at left followed by digits from the Alphanumeric characters in [Appendix D, Keypad](#) representing your desired character(s). End by scanning the ENTER/EXIT bar code again.

Make a mistake? Scan the CANCEL bar code to abort and not save the entry string. You can then start again at the beginning.

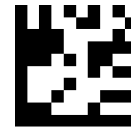

CANCEL

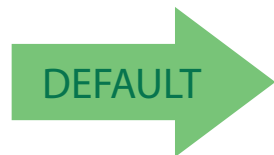

50 = Length 2 is 50 Characters



Code 32 (Italian Pharmaceutical)

The following options apply to the Code 32 symbology.

Code 32 Enable/Disable

When disabled, the scanner will not read Code 32 bar codes.

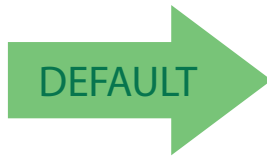

Code 32 = Disable



Code 32 = Enable

Code 32 Feature Setting Exceptions



NOTE

The following features are set for Code 32 by using these Code 39 settings:

"Code 39 Quiet Zones" on page 138

"Code 39 Length Control" on page 139

Code 32 Check Character Transmission

Enable this option to transmit the check character along with Code 32 bar code data.

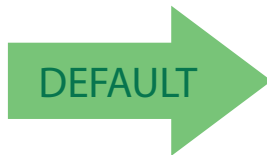

Code 32 Check Character Transmission = Don't Send



Code 32 Check Character Transmission = Send

Code 32 Start/Stop Character Transmission

This option enables/disables transmission of Code 32 start and stop characters.

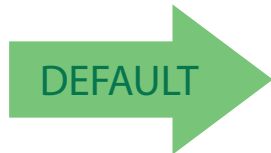

Code 32 Start/Stop Character Transmission = Don't Transmit



Code 32 Start/Stop Character Transmission = Transmit

Code 39 CIP (French Pharmaceutical)

The following options apply to the Code 39 CIP symbology.

Code 39 CIP Enable/Disable

Enables/Disables ability of the scanner to decode Code 39 CIP labels.

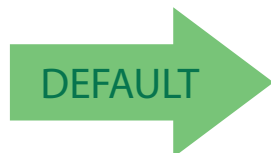

Code 39 CIP = Disable



Code 39 CIP = Enable



Code 128

The following options apply to the Code 128 symbology.

Code 128 Enable/Disable

When disabled, the scanner will not read Code 128 bar codes.



Code 128 = Disable



Code 128 = Enable



Expand Code 128 to Code 39

This feature enables/disables expansion of Code 128 labels to Code 39 labels. When enabled, the label identifier for a Code 128 label shall be set to Code 39 and all Code 39 formatting control shall be applied to the label.

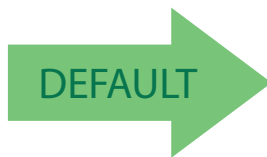

Code 128 to Code 39 = Don't Expand



Code 128 to Code 39 = Expand

Code 128 Check Character Transmission

Enable this option to transmit the check character along with Code 128 bar code data.

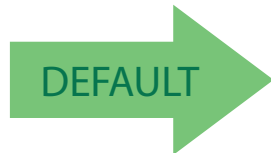

Code 128 Check Character Transmission = Don't Send



Code 128 Check Character Transmission = Send

Code 128 Function Character Transmission

Enables/disables transmission of Code128 function characters 1, 2, 3, and 4.

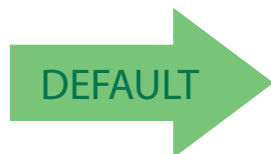

Code 128 Function Character Transmission = Don't Send



Code 128 Function Character Transmission = Send



Code 128 Quiet Zones

This feature specifies the number of quiet zones for Code 128 labels. Quiet zones are blank areas at the ends of a bar code and are typically 10 times the width of the narrowest bar or space in the label.



Code 128 Quiet Zones = No Quiet Zones



Code 128 Quiet Zones = Quiet Zone on one side



Code 128 Quiet Zones = Quiet Zones on two sides



Code 128 Quiet Zones = Auto



Code 128 Quiet Zones = Virtual Quiet Zones on two sides



Code 128 Length Control

This feature specifies either variable length decoding or fixed length decoding for the Code 128 symbology.

Variable Length: For variable length decoding, a minimum and maximum length may be set.

Fixed Length: For fixed length decoding, two different lengths may be set.

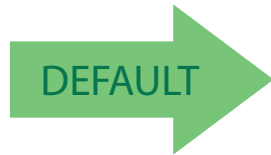

Code 128 Length Control = Variable Length



Code 128 Length Control = Fixed Length

Code 128 Set Length 1

This feature specifies one of the bar code lengths for **Code 128 Length Control** on page 147. Length 1 is the minimum label length if in **Variable Length** on page 147 Mode, or the first fixed length if in **Fixed Length** on page 147 Mode. Length includes the bar code's data characters only.

The length can be set from 1 to 80 characters. See "**Set Length 1**" on page 257 for more detailed programming instructions.



Select Code 128 Set Length 1 Setting

To configure this feature, scan the ENTER/EXIT bar code above, then the bar code at left followed by digits from the Alphanumeric characters in **Appendix D, Keypad** representing your desired character(s). End by scanning the ENTER/EXIT bar code again.

Make a mistake? Scan the CANCEL bar code to abort and not save the entry string. You can then start again at the beginning.

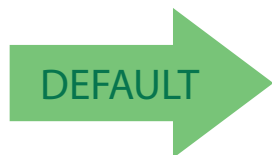
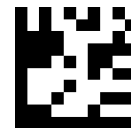

01 = Length 1 is 1 Character



Code 128 Set Length 2

This feature specifies one of the bar code lengths for Code 128 Length Control on page 147. Length 2 is the maximum label length if in Variable Length on page 147 Mode, or the second fixed length if in Fixed Length on page 147 Mode. Length includes the bar code's data characters only.

The length can be set from 1 to 80 characters. A setting of 00 specifies to ignore this length (only one fixed length). See "Set Length 2" on page 258 for more detailed programming instructions.



Select Code 128 Length 2 Setting

To configure this feature, scan the ENTER/EXIT bar code above, then the bar code at left followed by digits from the Alphanumeric characters in Appendix D, Keypad representing your desired character(s). End by scanning the ENTER/EXIT bar code again.

Make a mistake? Scan the CANCEL bar code to abort and not save the entry string. You can then start again at the beginning.



CANCEL

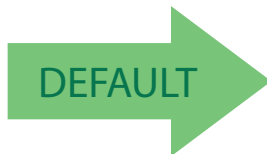

80 = Length 2 is 80 Characters



GS1-128

The following options apply to the GS1-128 symbology. (Also known as USS-128, GTIN-128, UCC-128.)

GS1-128 Enable

This option enables/disables the ability of the scanner to translate GS1-128 labels to the GS1-128 data format. Options are:

- Transmit GS1-128 labels in Code 128 data format.
- Transmit GS1-128 labels in GS1-128 data format.
- Do not transmit GS1-128 labels.



GS1-128 = Transmit in Code 128 data format



GS1-128 = Transmit in GS1-128 data format



GS1-128 = Do not transmit GS1-128 labels

GS1-128 2D Component

This feature enables/disables a requirement that a 2D label component be decoded when a base label of this symbology is decoded.

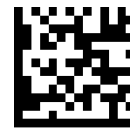
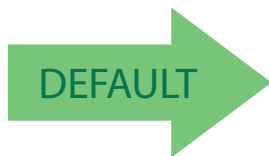

GS1-128 2D Component = Disable



GS1-128 2D Component = Enable



Interleaved 2 of 5 (I 2 of 5)

The following options apply to the I 2 of 5 symbology.



When reading this symbology, the settings for I 2 of 5 Length Control AND I 2 of 5 Check Character Calculation **MUST** be enabled to increase decoding safety.

I 2 of 5 Enable/Disable

When disabled, the scanner will not read I 2 of 5 bar codes.

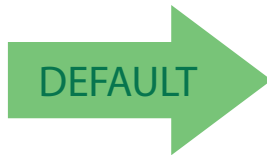

I 2 of 5 = Disable



I 2 of 5 = Enable

I 2 of 5 Check Character Calculation

This option enables/disables calculation and verification of an optional I 2 of 5 check character.

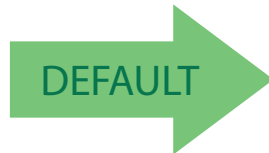

I 2 of 5 Check Char Calc = Disable



I 2 of 5 Check Char Calc = Check Standard
(Modulo 10)



I 2 of 5 Check Char Calc = Check German Parcel



I 2 of 5 Check Char Calc = Check DHL



I 2 of 5 Check Char Calc = Check Daimler Chrysler



I 2 of 5 Check Char Calc = Check Bosch



I 2 of 5 Check Character Calculation = Check Italian Post

When disabled, any check character in label is treated as a data character.



I 2 of 5 Check Character Transmission

Enable this option to transmit the check character along with I 2 of 5 bar code data.



NOTE

This feature is valid only when I 2 of 5 Check Character Calculation is enabled.



I 2 of 5 Check Character Transmission = Don't Send



I 2 of 5 Check Character Transmission = Send



I 2 of 5 Length Control

This feature specifies either variable length decoding or fixed length decoding for the I 2 of 5 symbology.

Variable Length: For variable length decoding, a minimum and maximum length may be set.

Fixed Length: For fixed length decoding, two different lengths may be set.

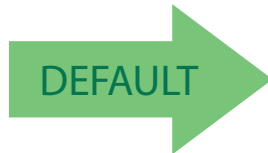

I 2 of 5 Length Control = Variable Length



I 2 of 5 Length Control = Fixed Length

I 2 of 5 Set Length 1

This feature specifies one of the bar code lengths for I 2 of 5 Length Control on page 152. Length 1 is the minimum label length if in Variable Length on page 157 Mode, or the first fixed length if in Fixed Length on page 157 Mode. The length includes the bar code's check and data characters.

The length can be set from 2 to 50 characters in increments of two. See "Set Length 1" on page 257 for more detailed programming instructions.



Select I 2 of 5 Length 1 Setting

To configure this feature, scan the ENTER/EXIT bar code above, then the bar code at left followed by digits from the Alphanumeric characters in [Appendix D, Keypad](#) representing your desired character(s). End by scanning the ENTER/EXIT bar code again.

Make a mistake? Scan the CANCEL bar code to abort and not save the entry string. You can then start again at the beginning.

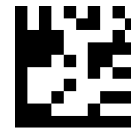

CANCEL

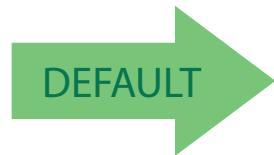

06 = Length 1 is 6 Characters



I 2 of 5 Set Length 2

This feature specifies one of the bar code lengths for I 2 of 5 Length Control on page 152. Length 2 is the maximum label length if in Variable Length on page 157 Mode, or the second fixed length if in Fixed Length on page 157 Mode. The length includes the bar code's check and data characters.

The length can be set from 2 to 50 characters. A setting of 0 specifies to ignore this length (only one fixed length). See "Set Length 2" on page 258 for more detailed programming instructions.



Select I 2 of 5 Length 2 Setting

To configure this feature, scan the ENTER/EXIT bar code above, then the bar code at left followed by digits from the Alphanumeric characters in Appendix D, Keypad representing your desired character(s). End by scanning the ENTER/EXIT bar code again.

Make a mistake? Scan the CANCEL bar code to abort and not save the entry string. You can then start again at the beginning.



CANCEL

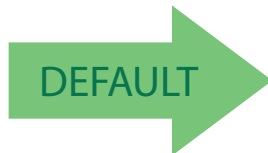

50 = Length 2 is 50 Characters

Interleaved 2 of 5 CIP HR

The following options apply to the Interleaved 2 of 5 CIP HR symbology.

Interleaved 2 of 5 CIP HR Enable/Disable

Enables/Disables ability of scanner to decode Interleaved 2 of 5 CIP HR labels.

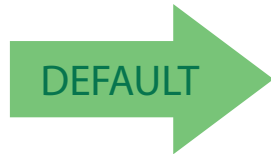

Interleaved 2 of 5 CIP HR = Disable



Interleaved 2 of 5 CIP HR = Enable

Datalogic 2 of 5

The following options apply to the Datalogic 2 of 5 symbology.

Datalogic 2 of 5 Enable/Disable

When disabled, the scanner will not read Datalogic 2 of 5 bar codes.

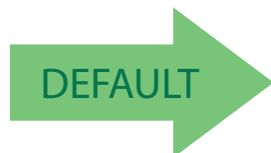

Datalogic 2 of 5 = Disable



Datalogic 2 of 5 = Enable



Datalogic 2 of 5 Check Character Calculation

This option enables/disables calculation and verification of an optional Datalogic 2 of 5 check character.

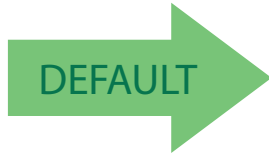

Datalogic 2 of 5 Check Character Calculation = Disable



Datalogic 2 of 5 Check Character Calculation = Enable

Datalogic 2 of 5 Check Character Transmission

This option enables/disables transmission of an optional Datalogic 2 of 5 character.



Datalogic 2 of 5 Check Character Transmission = Don't Send



Datalogic 2 of 5 Check Character Transmission = Send



Datalogic 2 of 5 Length Control

This feature specifies either variable length decoding or fixed length decoding for the Datalogic 2 of 5 symbology.

Variable Length: For variable length decoding, a minimum and maximum length may be set.

Fixed Length: For fixed length decoding, two different lengths may be set.

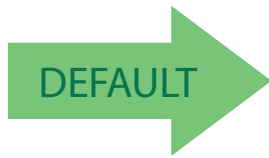

Datalogic 2 of 5 Length Control = Variable Length



Datalogic 2 of 5 Length Control = Fixed Length

Datalogic 2 of 5 Set Length 1

This feature specifies one of the bar code lengths for [Datalogic 2 of 5 Length Control on page 157](#). Length 1 is the minimum label length if in [Variable Length on page 152 Mode](#), or the first fixed length if in [Fixed Length on page 152 Mode](#). The length includes the bar code's data characters only.

The length can be set from 2 to 50 characters in increments of two. See "[Set Length 1](#)" on page 257 for more detailed programming instructions.

42001



Select Datalogic 2 of 5 Length 1 Setting

To configure this feature, scan the ENTER/EXIT bar code above, then the bar code at left followed by digits from the Alphanumeric characters in [Appendix D, Keypad](#) representing your desired character(s). End by scanning the ENTER/EXIT bar code again.

Make a mistake? Scan the CANCEL bar code to abort and not save the entry string. You can then start again at the beginning.

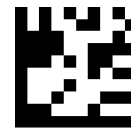

CANCEL

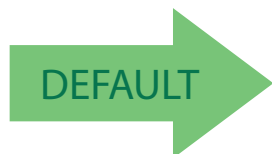

06 = Length 1 is 6 Characters



Datalogic 2 of 5 Set Length 2

This feature specifies one of the bar code lengths for [Datalogic 2 of 5 Length Control on page 157](#). Length 2 is the maximum label length if in [Variable Length on page 152 Mode](#), or the second fixed length if in [Fixed Length on page 152 Mode](#). The length includes the bar code's data characters only.

The length can be set from 2 to 50 characters. A setting of 00 specifies to ignore this length (only one fixed length). See ["Set Length 2" on page 258](#) for more detailed programming instructions.



Select Datalogic 2 of 5 Length 2 Setting

To configure this feature, scan the ENTER/EXIT bar code above, then the bar code at left followed by digits from the Alphanumeric characters in [Appendix D, Keypad](#) representing your desired character(s). End by scanning the ENTER/EXIT bar code again.

Make a mistake? Scan the CANCEL bar code to abort and not save the entry string. You can then start again at the beginning.

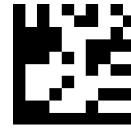

CANCEL

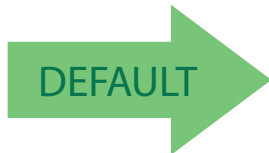

50 = Length 2 is 50 Characters

Codabar

The following options apply to the Codabar symbology.

Codabar Enable/Disable

When disabled, the scanner will not read Codabar bar codes.

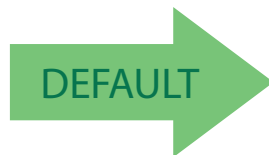

Codabar = Disable



Codabar = Enable

Codabar Check Character Calculation

Enable this option to enables/disables calculation and verification of an optional Codabar check character. When disabled, any check characters in the label are treated as data characters.

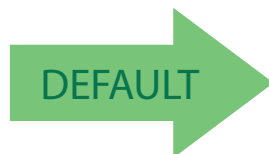

Codabar Check Character Calculation = Don't Calculate



Codabar Check Character Calculation = Enable AIM standard check char.



Codabar Check Character Calculation = Enable Modulo 10 check char.



Codabar Check Character Transmission

Enable this option to transmit the check character along with Codabar bar code data.



This feature is valid only when Codabar Check Character Calculation is enabled.

NOTE



Codabar Check Character Transmission = Don't Send



Codabar Check Character Transmission = Send



Codabar Start/Stop Character Transmission

Enable this option to enable/disable transmission of Codabar start and stop characters.



Codabar Start/Stop Character Transmission = Don't Transmit



Codabar Start/Stop Character Transmission = Transmit



Codabar Start/Stop Character Set

This option specifies the format of transmitted Codabar start/stop characters.



Codabar Check Character Set = ABCD/TN*E



Codabar Check Character Set = ABCD/ABCD



Codabar Check Character Set = abcd/tn*e



Codabar Check Character Set = abcd/abcd



Codabar Start/Stop Character Match

When enabled, this option requires that start and stop characters match.

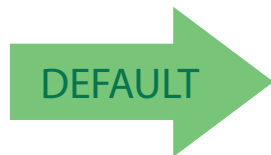

Codabar Start/Stop Character Match = Don't Require Match



Codabar Start/Stop Character Match = Require Match



Codabar Quiet Zones

This feature specifies the number of quiet zones for Codabar labels. Quiet zones are blank areas at the ends of a bar code and are typically 10 times the width of the narrowest bar or space in the label.

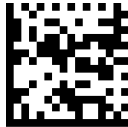

Codabar Quiet Zones = Quiet Zone on one side



Codabar Quiet Zones = Quiet Zones on two sides



Codabar Quiet Zones = Auto



DEFAULT



Codabar Quiet Zones = Virtual Quiet Zones on two sides



Codabar Quiet Zones = Small Quiet Zones on two sides



Codabar Length Control

This feature specifies either variable length decoding or fixed length decoding for the Codabar symbology.

Variable Length: For variable length decoding, a minimum and maximum length may be set.

Fixed Length: For fixed length decoding, two different lengths may be set.

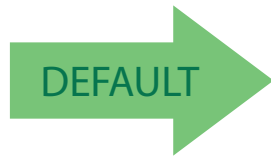

Codabar Length Control = Variable Length



Codabar Length Control = Fixed Length

Codabar Set Length 1

This feature specifies one of the bar code lengths for [Codabar Length Control on page 163](#). Length 1 is the minimum label length if in [Variable Length on page 163 Mode](#), or the first fixed length if in [Fixed Length on page 163 Mode](#). Length includes the bar code's start, stop, check and data characters. The length must include at least one data character.

The length can be set from 3 to 50 characters. See ["Set Length 1" on page 257](#) for more detailed programming instructions.



Select Codabar Length 1 Setting

To configure this feature, scan the ENTER/EXIT bar code above, then the bar code at left followed by digits from the Alphanumeric characters in [Appendix D, Keypad](#) representing your desired character(s). End by scanning the ENTER/EXIT bar code again.

Make a mistake? Scan the CANCEL bar code to abort and not save the entry string. You can then start again at the beginning.

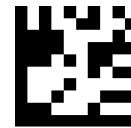

CANCEL

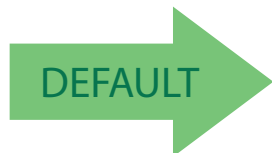

03 = Length 1 is 3 Characters



Codabar Set Length 2

This feature specifies one of the bar code lengths for [Codabar Length Control on page 163](#). Length 2 is the maximum label length if in [Variable Length on page 163 Mode](#), or the second fixed length if in [Fixed Length on page 163 Mode](#). The length includes the bar code's start, stop, check and data characters. The length must include at least one data character.

The length can be set from 3 to 50 characters. A setting of 00 specifies to ignore this length (only one fixed length). See ["Set Length 2" on page 258](#) for more detailed programming instructions.



Select Codabar Length 2 Setting

To configure this feature, scan the ENTER/EXIT bar code above, then the bar code at left followed by digits from the Alphanumeric characters in [Appendix D, Keypad](#) representing your desired character(s). End by scanning the ENTER/EXIT bar code again.

Make a mistake? Scan the CANCEL bar code to abort and not save the entry string. You can then start again at the beginning.

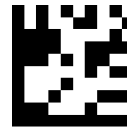

CANCEL

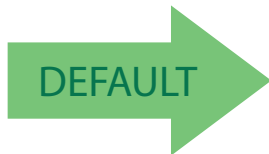

50 = Length 2 is 50 Characters

ABC Codabar

The following options apply to the ABC Codabar symbology.

ABC Codabar Enable/Disable

Enables/Disables ability of scanner to decode ABC Codabar labels.

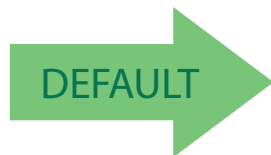

ABC Codabar = Disable



ABC Codabar = Enable

ABC Codabar Concatenation Mode

Specifies the concatenation mode between Static and Dynamic.

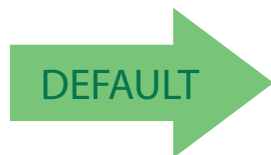

ABC Codabar Concatenation Mode = Static



ABC Codabar Concatenation Mode = Dynamic



ABC Codabar Dynamic Concatenation Timeout

This parameter specifies the timeout in 10–millisecond ticks used by the ABC Codabar Dynamic Concatenation Mode. The timeout can be set within a range of 05 to 255 in 10ms increments. A setting of zero specifies no delay.



Select ABC Codabar Dynamic Concatenation Timeout Setting

To configure this feature, scan the ENTER/EXIT bar code above, then the bar code at left followed by digits from the Alphanumeric characters in [Appendix D, Keypad](#) representing your desired character(s). End by scanning the ENTER/EXIT bar code again.

Make a mistake? Scan the CANCEL bar code to abort and not save the entry string. You can then start again at the beginning.



CANCEL

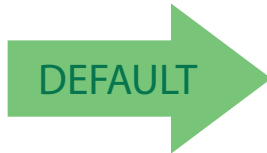

10 = Quiet Interval of 200 ms

ABC Codabar Force Concatenation

When ABC Codabar Concatenation is enabled and Force Concatenation is disabled, both Codabar stand alone labels and ABC Codabar concatenated labels are transmitted. When ABC Codabar Concatenation is enabled and Force Concatenation is enabled only ABC Codabar concatenated labels are transmitted while Codabar stand alone labels are not transmitted.

Force Concatenation has no effect if the ABC Codabar Concatenation is disabled. The Force Concatenation mode has effect both in Static and Dynamic Concatenation Modes.

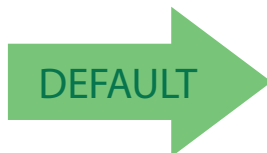

ABC Codabar Force Concatenation = Disable



ABC Codabar Force Concatenation = Enable

Code 11

The following options apply to the Code 11 symbology.

Code 11 Enable/Disable

When disabled, the scanner will not read Code 11 bar codes.

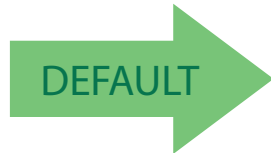

Code 11 = Disable



Code 11 = Enable

Code 11 Check Character Calculation

This option enables/disables calculation and verification of optional Code 11 check character.



Code 11 Check Character Calculation = Disable



Code 11 Check Character Calculation = Check C



Code 11 Check Character Calculation = Check K



Code 11 Check Character Calculation = Check C and K





Code 11 Check Character Transmission

This feature enables/disables transmission of an optional Code 11 check character.



Code 11 Check Character Transmission = Don't Send



Code 11 Check Character Transmission = Send



Code 11 Length Control

This feature specifies either variable length decoding or fixed length decoding for the Code 11 symbology.

Variable Length: For variable length decoding, a minimum and maximum length may be set.

Fixed Length: For fixed length decoding, two different lengths may be set.

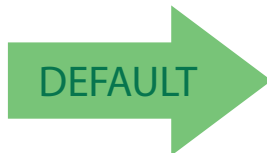

Code 11 Length Control = Variable Length



Code 11 Length Control = Fixed Length

Code 11 Set Length 1

This feature specifies one of the bar code lengths for [Code 11 Length Control on page 168](#). Length 1 is the minimum label length if in [Variable Length on page 168 Mode](#), or the first fixed length if in [Fixed Length on page 168 Mode](#). Length includes the bar code's check and data characters.

The length can be set from 2 to 50 characters. See ["Set Length 1" on page 257](#) for more detailed programming instructions.



Select Code 11 Set Length 1 Setting

To configure this feature, scan the ENTER/EXIT bar code above, then the bar code at left followed by digits from the Alphanumeric characters in [Appendix D, Keypad](#) representing your desired character(s). End by scanning the ENTER/EXIT bar code again.

Make a mistake? Scan the CANCEL bar code to abort and not save the entry string. You can then start again at the beginning.

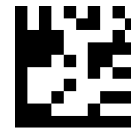

CANCEL

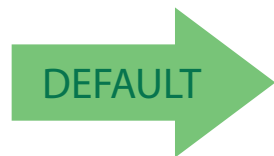

04 = Length 1 is 4 Characters



Code 11 Set Length 2

This feature specifies one of the bar code lengths for [Code 11 Length Control on page 168](#). Length 2 is the maximum label length if in [Variable Length on page 168 Mode](#), or the second fixed length if in [Fixed Length on page 168 Mode](#). Length includes the bar code's check and data characters.

The length can be set from 2 to 50 characters. A setting of 00 specifies to ignore this length (only one fixed length). See "[Set Length 2](#)" on page 258 for more detailed programming instructions.



Select Code 11 Length 2 Setting

To configure this feature, scan the ENTER/EXIT bar code above, then the bar code at left followed by digits from the Alphanumeric characters in [Appendix D, Keypad](#) representing your desired character(s). End by scanning the ENTER/EXIT bar code again.

Make a mistake? Scan the CANCEL bar code to abort and not save the entry string. You can then start again at the beginning.



CANCEL

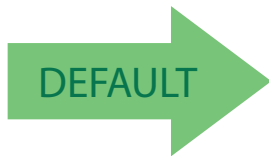

50 = Length 2 is 50 Characters

Standard 2 of 5

The following options apply to the Standard 2 of 5 symbology.

Standard 2 of 5 Enable/Disable

When disabled, the scanner will not read Standard 2 of 5 bar codes.

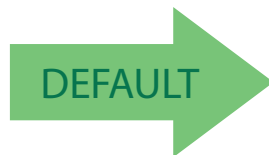

Standard 2 of 5 = Disable



Standard 2 of 5 = Enable

Standard 2 of 5 Check Character Calculation

This option enables/disables calculation and verification of an optional Standard 2 of 5 check character.

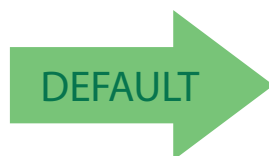

Standard 2 of 5 Check Character Calculation = Disable



Standard 2 of 5 Check Character Calculation = Enable



Standard 2 of 5 Check Character Transmission

This feature enables/disables transmission of an optional Standard 2 of 5 check character.



Standard 2 of 5 Check Character Transmission = Don't Send



Standard 2 of 5 Check Character Transmission = Send



Standard 2 of 5 Length Control

This feature specifies either variable length decoding or fixed length decoding for the Standard 2 of 5 symbology.

Variable Length: For variable length decoding, a minimum and maximum length may be set.

Fixed Length: For fixed length decoding, two different lengths may be set.

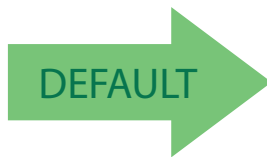

Standard 2 of 5 Length Control = Variable Length



Standard 2 of 5 Length Control = Fixed Length

Standard 2 of 5 Set Length 1

This feature specifies one of the bar code lengths for [Standard 2 of 5 Length Control on page 172](#). Length 1 is the minimum label length if in [Variable Length on page 172 Mode](#), or the first fixed length if in [Fixed Length on page 172 Mode](#). Length includes the bar code's check and data characters.

The length can be set from 1 to 50 characters. See ["Set Length 1" on page 257](#) for more detailed programming instructions.

W581



Select Standard 2 of 5 Length 1 Setting

To configure this feature, scan the ENTER/EXIT bar code above, then the bar code at left followed by digits from the Alphanumeric characters in [Appendix D, Keypad](#) representing your desired character(s). End by scanning the ENTER/EXIT bar code again.

Make a mistake? Scan the CANCEL bar code to abort and not save the entry string. You can then start again at the beginning.

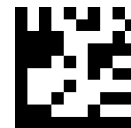

CANCEL

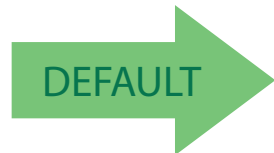

08 = Length 1 is 8 Characters



Standard 2 of 5 Set Length 2

This feature specifies one of the bar code lengths for **Standard 2 of 5 Length Control** on page 172. Length 2 is the maximum label length if in **Variable Length** on page 172 Mode, or the second fixed length if in **Fixed Length** on page 172 Mode. Length includes the bar code's check and data characters. The length can be set from 1 to 50 characters. A setting of 00 specifies to ignore this length (only one fixed length). See "**Set Length 2**" on page 258 for more detailed programming instructions.



Select Standard 2 of 5 Length 2 Setting

To configure this feature, scan the ENTER/EXIT bar code above, then the bar code at left followed by digits from the Alphanumeric characters in **Appendix D, Keypad** representing your desired character(s). End by scanning the ENTER/EXIT bar code again.

Make a mistake? Scan the CANCEL bar code to abort and not save the entry string. You can then start again at the beginning.

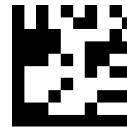

CANCEL

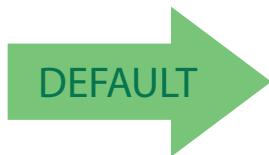

50 = Length 2 is 50 Characters

Industrial 2 of 5

The following options apply to the Industrial 2 of 5 symbology.

Industrial 2 of 5 Enable/Disable

Enables/Disables ability of scanner to decode Industrial 2 of 5 labels.

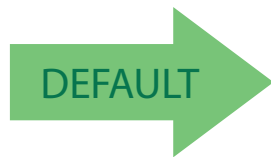

Industrial 2 of 5 = Disable



Industrial 2 of 5 = Enable

Industrial 2 of 5 Check Character Calculation

Enables/Disables calculation and verification of an optional Industrial 2 of 5 check character.

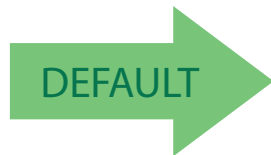

Industrial 2 of 5 Check Character Calculation = Disable



Industrial 2 of 5 Check Character Calculation = Enable



Industrial 2 of 5 Check Character Transmission

Enables/disables transmission of an Industrial 2 of 5 check character.



Industrial 2 of 5 Check Character Transmission = Disable



Industrial 2 of 5 Check Character Transmission = Enable

Industrial 2 of 5 Length Control

This feature specifies either variable length decoding or fixed length decoding for the Industrial 2 of 5 symbology.

Variable Length: For variable length decoding, a minimum and maximum length may be set.

Fixed Length: For fixed length decoding, two different lengths may be set.

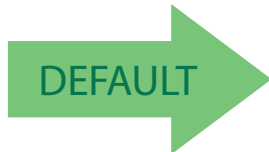

Industrial 2 of 5 Length Control = Variable Length



Industrial 2 of 5 = Fixed Length



Industrial 2 of 5 Set Length 1

This feature specifies one of the bar code lengths for **Industrial 2 of 5 Length Control** on page 176. Length 1 is the minimum label length if in **Variable Length** on page 139 Mode, or the first fixed length if in **Fixed Length** on page 139 Mode. Length includes the bar code's data characters only.

The length can be set from 1 to 50 characters. See "**Set Length 1**" on page 257 for more detailed programming instructions.



Select Industrial 2 of 5 Set Length 1 Setting

To configure this feature, scan the ENTER/EXIT bar code above, then the bar code at left followed by digits from the Alphanumeric characters in **Appendix D, Keypad** representing your desired character(s). End by scanning the ENTER/EXIT bar code again.

Make a mistake? Scan the CANCEL bar code to abort and not save the entry string. You can then start again at the beginning.

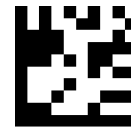

CANCEL

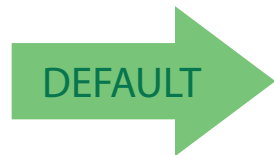

01 = Length 1 is 1 Character



Industrial 2 of 5 Set Length 2

This feature specifies one of the bar code lengths for **Industrial 2 of 5 Length Control** on page 176. Length 2 is the maximum label length if in **Variable Length** on page 139 Mode, or the second fixed length if in **Fixed Length** on page 139 Mode. Length includes the bar code's check, data, and full-ASCII shift characters. The length does not include start/stop characters.

The length can be set from 1 to 50 characters. A setting of 00 specifies to ignore this length (only one fixed length). See **"Set Length 2"** on page 258 for more detailed programming instructions.



Select Industrial 2 of 5 Length 2 Setting

To configure this feature, scan the ENTER/EXIT bar code above, then the bar code at left followed by digits from the Alphanumeric characters in **Appendix D, Keypad** representing your desired character(s). End by scanning the ENTER/EXIT bar code again.

Make a mistake? Scan the CANCEL bar code to abort and not save the entry string. You can then start again at the beginning.



CANCEL

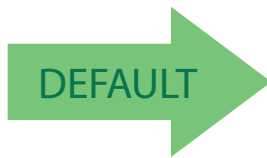

50 = Length 2 is 50 Characters

IATA

The following options apply to the IATA symbology.

IATA Enable/Disable

Enables/Disables the ability of the scanner to decode IATA labels.



IATA Check Character Transmission

Enables/Disables calculation and verification of an optional Industrial 2 of 5 check character.

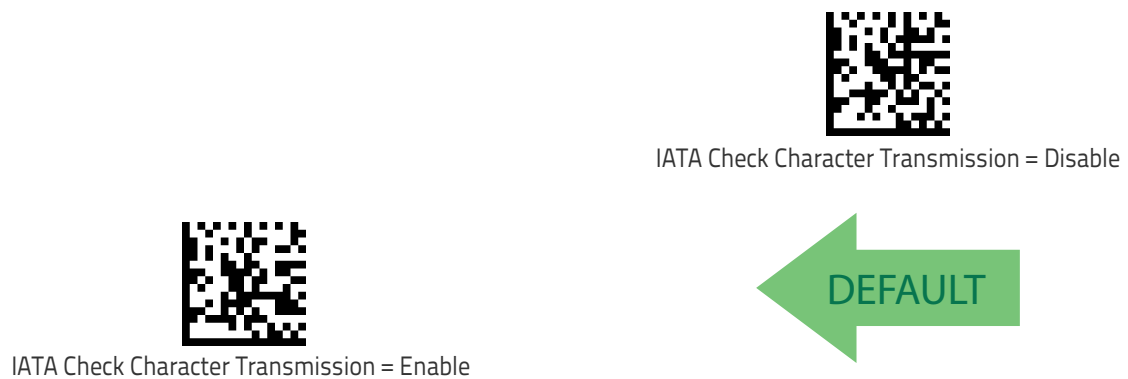



ISBT 128

The following options apply to the ISBT 128 symbology.

ISBT 128 Concatenation

Enables/disables ISBT128 concatenation of 2 labels.

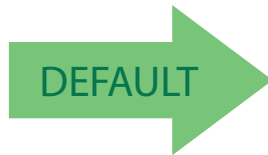

ISBT 128 Concatenation = Disable



ISBT 128 Concatenation = Enable

ISBT 128 Concatenation Mode

Specifies the concatenation mode between Static and Dynamic.



NOTE

This option is only valid when ISBT 128 Concatenation on page 180 is enabled (see page 11-180).

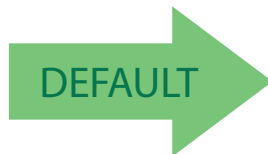

ISBT 128 Concatenation Mode = Static



ISBT 128 Concatenation Mode = Dynamic

ISBT 128 Dynamic Concatenation Timeout

Specifies the timeout used by the ISBT 128 Dynamic Concatenation Mode.



ISBT 128 Dynamic Concatenation Timeout = 50 msec



ISBT 128 Dynamic Concatenation Timeout = 100 msec

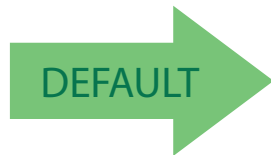

ISBT 128 Dynamic Concatenation Timeout = 200 msec



ISBT 128 Dynamic Concatenation Timeout = 500 msec



ISBT 128 Dynamic Concatenation Timeout = 750 msec



ISBT 128 Dynamic Concatenation Timeout = 1 second



ISBT 128 Force Concatenation

When enabled, this feature forces all ISBT 128 labels to be concatenated.



NOTE

This option is only valid when ISBT 128 Concatenation on page 180 is enabled. (see page 11-180).

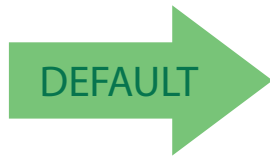

ISBT 128 Force Concatenation = Disable



ISBT 128 Force Concatenation = Enable

ISBT 128 Advanced Concatenation Options



NOTE

Use the Datalogic Aladdin configuration application or Contact Customer Support to set up pairs of label types for concatenation.

MSI

The following options apply to the MSI symbology.

MSI Enable/Disable

Enables/Disables ability of scanner to decode MSI labels.



MSI Check Character Calculation

Enables/Disables calculation and verification of an optional MSI check character.

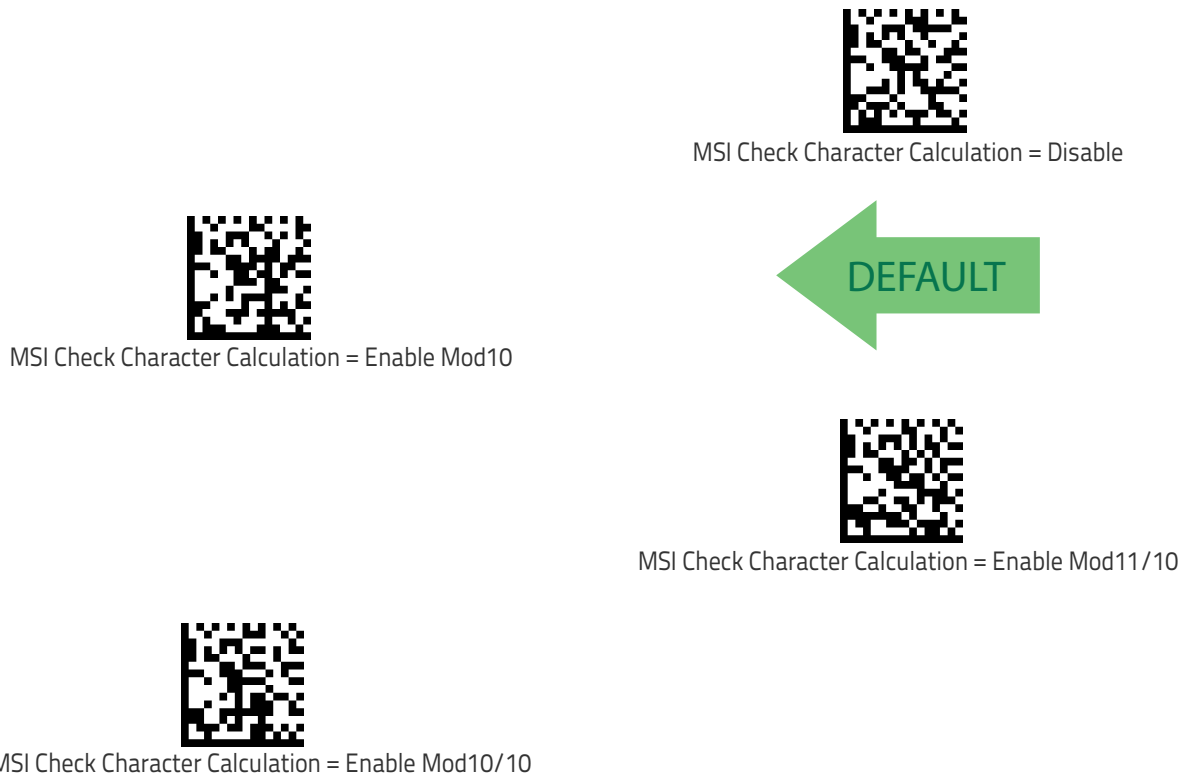



MSI Check Character Transmission

Enables/disables transmission of an MSI check character.



MSI Check Character Transmission = Disable



MSI Check Character Transmission = Enable



MSI Length Control

This feature specifies either variable length decoding or fixed length decoding for the MSI symbology.

Variable Length: For variable length decoding, a minimum and maximum length may be set.

Fixed Length: For fixed length decoding, two different lengths may be set.

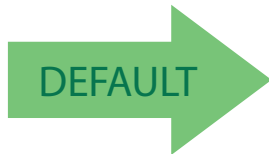

MSI Length Control = Variable Length



MSI = Fixed Length

MSI Set Length 1

This feature specifies one of the bar code lengths for **MSI Length Control** on page 184. Length 1 is the minimum label length if in **Variable Length** on page 184 Mode, or the first fixed length if in **Fixed Length** on page 184 Mode. Length includes the bar code's data characters only.

The length can be set from 01 to 50 characters. See "Set Length 1" on page 257 for more detailed programming instructions.



Select MSI Set Length 1 Setting

To configure this feature, scan the ENTER/EXIT bar code above, then the bar code at left followed by digits from the Alphanumeric characters in **Appendix D, Keypad** representing your desired character(s). End by scanning the ENTER/EXIT bar code again.

Make a mistake? Scan the CANCEL bar code to abort and not save the entry string. You can then start again at the beginning.

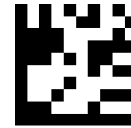

CANCEL

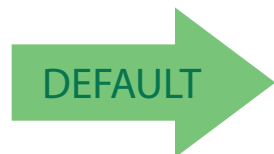

01 = Length 1 is 1 Character



MSI Set Length 2

This feature specifies one of the bar code lengths for [MSI Length Control on page 184](#). Length 2 is the maximum label length if in [Variable Length on page 184 Mode](#), or the second fixed length if in [Fixed Length on page 184 Mode](#). Length includes the bar code's check, data, and full-ASCII shift characters. The length does not include start/stop characters.

The length can be set from 1 to 50 characters. A setting of 0 specifies to ignore this length (only one fixed length). See ["Set Length 2" on page 258](#) for more detailed programming instructions.



Select MSI Length 2 Setting

To configure this feature, scan the ENTER/EXIT bar code above, then the bar code at left followed by digits from the Alphanumeric characters in [Appendix D, Keypad](#) representing your desired character(s). End by scanning the ENTER/EXIT bar code again.

Make a mistake? Scan the CANCEL bar code to abort and not save the entry string. You can then start again at the beginning.

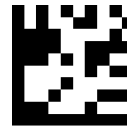

CANCEL

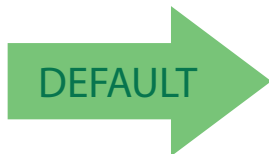

50 = Length 2 is 50 Characters

Code 93

The following options apply to the Code 93 symbology.

Code 93 Enable/Disable

Enables/Disables ability of scanner to decode Code 93 labels.

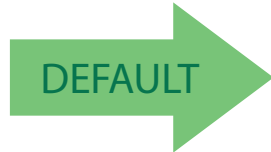

Code 93 = Disable



Code 93 = Enable

Code 93 Check Character Calculation

Enables/disables calculation and verification of an optional Code 93 check character.



Code 93 Check Character Calculation = Disable



Code 93 Check Character Calculation = Enable Check C



Code 93 Check Character Calculation = Enable Check K



Code 93 Check Character Calculation =
Enable Check C and K





Code 93 Check Character Transmission

Enables/disables transmission of an optional Code 93 check character.



Code 93 Check Character Transmission = Disable



Code 93 Check Character Transmission = Enable



Code 93 Length Control

This feature specifies either variable length decoding or fixed length decoding for the Code 93 symbology.

Variable Length: For variable length decoding, a minimum and maximum length may be set.

Fixed Length: For fixed length decoding, two different lengths may be set.

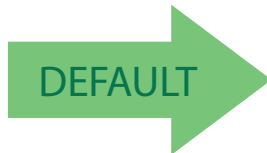

Code 93 Length Control = Variable Length



Code 93 = Fixed Length

Code 93 Set Length 1

This feature specifies one of the bar code lengths for **Code 93 Length Control** on page 188. Length 1 is the minimum label length if in **Variable Length** on page 188 Mode, or the first fixed length if in **Fixed Length** on page 188 Mode. Length includes the bar code's data characters only.

The length can be set from 01 to 50 characters. See "**Set Length 1**" on page 257 for more detailed programming instructions.



Select Code 93 Set Length 1 Setting

To configure this feature, scan the ENTER/EXIT bar code above, then the bar code at left followed by digits from the Alphanumeric characters in **Appendix D, Keypad** representing your desired character(s). End by scanning the ENTER/EXIT bar code again.

Make a mistake? Scan the CANCEL bar code to abort and not save the entry string. You can then start again at the beginning.

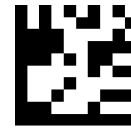

CANCEL

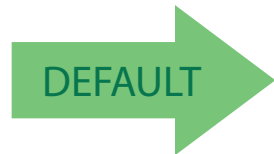

01 = Length 1 is 1 Character



Code 93 Set Length 2

This feature specifies one of the bar code lengths for [Code 93 Length Control on page 188](#). Length 2 is the maximum label length if in [Variable Length on page 188 Mode](#), or the second fixed length if in [Fixed Length on page 188 Mode](#). Length includes the bar code's check, data, and full-ASCII shift characters. The length does not include start/stop characters.

The length can be set from 1 to 50 characters. A setting of 00 specifies to ignore this length (only one fixed length). See "[Set Length 2](#)" on page 258 for more detailed programming instructions.



Select Code 93 Length 2 Setting

To configure this feature, scan the ENTER/EXIT bar code above, then the bar code at left followed by digits from the Alphanumeric characters in [Appendix D, Keypad](#) representing your desired character(s). End by scanning the ENTER/EXIT bar code again.

Make a mistake? Scan the CANCEL bar code to abort and not save the entry string. You can then start again at the beginning.

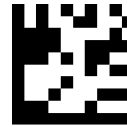

CANCEL

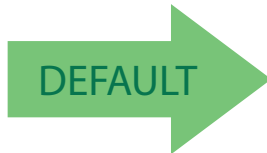

50 = Length 2 is 50 Characters

Code 93 Quiet Zones

Enables/disables fixed length stitching for Code 93.



This feature is available only on the TD1130 model.

NOTE



Code 93 Quiet Zones = No Quiet Zones



Code 93 Quiet Zones = Quiet Zone on one side



Code 93 Quiet Zones = Quiet Zones on two sides



Code 93 Quiet Zones = Auto



Code 93 Quiet Zones = Virtual Quiet Zones on two sides



Follett 2 of 5

The following options apply to the Follett 2 of 5 symbology.

Follett 2 of 5 Enable/Disable

Enables/Disables ability of scanner to decode Follett 2 of 5 labels.

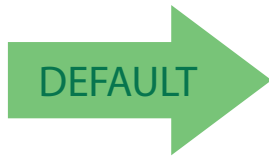

Follett 2 of 5 = Disable



Follett 2 of 5 = Enable

BC412

The following options apply to the BC412 symbology.

BC412 Enable/Disable

Enables/Disables ability of scanner to decode BC412 labels.

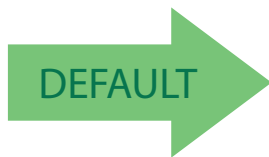

BC412 = Disable



BC412 = Enable

BC412 Check Character Calculation

Enable this option to enable/disable calculation and verification of an optional BC412 check character. When disabled, any check character in the label is treated as a data character.

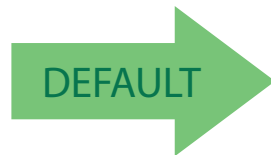

BC412 Check Character Calculation = Don't Calculate



BC412 Check Character Calculation = Calculate Check Character

BC412 Length Control

This feature specifies either variable length decoding or fixed length decoding for the BC412 symbology.

Variable Length: For variable length decoding, a minimum and maximum length may be set.

Fixed Length: For fixed length decoding, two different lengths may be set.

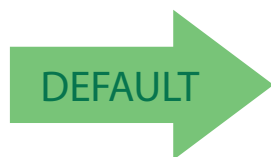

BC412 Length Control = Variable Length



BC412 Length Control = Fixed Length



BC412 Set Length 1

This feature specifies one of the bar code lengths for BC412 Length Control on page 193. Length 1 is the minimum label length if in Variable Length on page 193 Mode, or the first fixed length if in Fixed Length on page 193 Mode. Length includes the bar code's data characters only.

The length can be set from 01 to 50 characters. See "Set Length 1" on page 257 for more detailed programming instructions.



Select BC412 Set Length 1 Setting

To configure this feature, scan the ENTER/EXIT bar code above, then the bar code at left followed by digits from the Alphanumeric characters in [Appendix D, Keypad](#) representing your desired character(s). End by scanning the ENTER/EXIT bar code again.

Make a mistake? Scan the CANCEL bar code to abort and not save the entry string. You can then start again at the beginning.

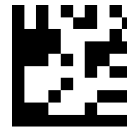

CANCEL

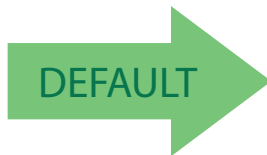

01 = Length 1 is 1 Character

BC412 Set Length 2

This feature specifies one of the bar code lengths for **BC412 Length Control** on page 193. Length 2 is the maximum label length if in **Variable Length** on page 193 Mode, or the second fixed length if in **Fixed Length** on page 193 Mode. Length includes the bar code's check, data, and full-ASCII shift characters. The length does not include start/stop characters.

The length can be set from 1 to 50 characters. A setting of 00 specifies to ignore this length (only one fixed length). See "**Set Length 2**" on page 258 for more detailed programming instructions.



Select BC412 Length 2 Setting

To configure this feature, scan the ENTER/EXIT bar code above, then the bar code at left followed by digits from the Alphanumeric characters in **Appendix D, Keypad** representing your desired character(s). End by scanning the ENTER/EXIT bar code again.

Make a mistake? Scan the CANCEL bar code to abort and not save the entry string. You can then start again at the beginning.

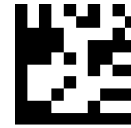

CANCEL

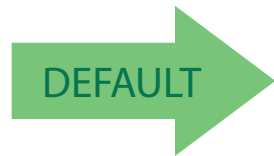

50 = Length 2 is 50 Characters

NOTES

2D Symbologies

2D Global Features	
• 2D MAXIMUM DECODING TIME on page 202	• 2D NORMAL/INVERSE SYMBOL CONTROL on page 203
• 2D STRUCTURED APPEND on page 203	

The reader supports the following 2D symbologies (bar code types). Symbology-dependent options for each symbology are included in this chapter. See "1D Symbologies" starting on page 113 for configuration of 1D bar codes.

2D Symbologies	
• AZTEC CODE on page 204	• MICRO PDF417 on page 219
• CHINA SENSIBLE CODE on page 207	• QR CODE on page 222
• DATA MATRIX on page 210	• MICRO QR CODE on page 225
• MAXICODE on page 213	• UCC COMPOSITE on page 228
• PDF417 on page 216	• POSTAL CODE SELECTION on page 229

2D Global Features

The following features are common to all, or in some cases, most of the available 2D symbologies. Default settings are indicated at each feature/option with a green arrow. Also reference [Appendix B, Standard Defaults](#) for a listing of the most widely used set of standard factory settings. That section also provides space to record any custom settings needed or implemented for your system.

To set most features:

1. Scan the ENTER/EXIT PROGRAMMING bar code at the top of applicable programming pages.
2. Scan the correct bar code to set the desired programming feature or parameter. You may need to cover unused bar codes on the page, and possibly the facing page, to ensure that the reader reads only the bar code you intend to scan.
3. If additional input parameters are needed, go to [Appendix D, Keypad](#), and scan the appropriate characters from the keypad.



NOTE

Additional information about many features can be found in the "References" chapter.

If you make a mistake before the last character, scan the CANCEL bar code to abort and not save the entry string. You can then start again at the beginning.

Complete the programming sequence by scanning the ENTER/EXIT PROGRAMMING bar code to exit Programming Mode.



2D Maximum Decoding Time

This feature specifies the maximum amount of time the software will spend attempting to decode a 2D label. The selectable range is 10 milliseconds to 2.55 milliseconds.



2D Maximum Decoding Time = 100 msec



2D Maximum Decoding Time = 200 msec



2D Maximum Decoding Time = 350 msec



2D Maximum Decoding Time = 500 msec



2D Maximum Decoding Time = 1 Second



2D Maximum Decoding Time = 2 Seconds



2D Maximum Decoding Time = 2.55 Seconds



2D Structured Append

Enables/disables ability of reader to append multiple 2D Codes labels in a structured format. The structured append property is globally applied to the following symbologies, if these are enabled:

- Data Matrix
- QR Code
- Aztec
- PDF 417

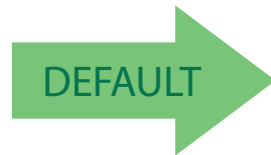

Structured Append = Disable



Structured Append = Enable

2D Normal/Inverse Symbol Control

Specifies the options available for decoding normal/negative printed 2D symbols. This configuration item applies globally to all the 2D symbologies that support that feature according to Standard AIM Specification: Data Matrix, QR, MicroQR, Aztec and Chinese Sensible Code.

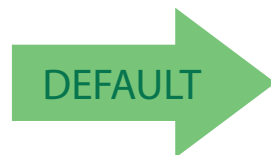

Normal/Inverse Symbol Control = Normal



Normal/Inverse Symbol Control = Inverse



Normal/Inverse Symbol Control =
Both Normal and Inverse



Symbology Selection

Aztec Code

Aztec Code Enable / Disable

Enables/disables the ability of the reader to decode Aztec Code labels.

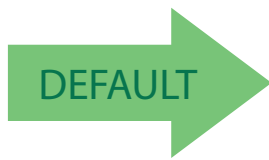

Aztec Code = Disable



Aztec Code = Enable

Aztec Code Length Control

This feature specifies either variable length decoding or fixed length decoding for this symbology.

Variable Length: For variable length decoding, a minimum and maximum length may be set.

Fixed Length: For fixed length decoding, two different lengths may be set.

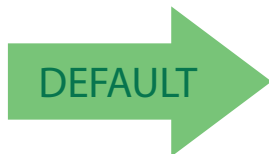

Aztec Code Length Control = Variable Length



Aztec Code Length Control = Fixed Length



Aztec Code Set Length 1

Specifies one of the bar code lengths for [Aztec Code Length Control on page 204](#). Length 1 is the minimum label length if in [Variable Length Mode](#), or the first fixed length if in [Fixed Length Mode](#). Characters can be set from 0001 to 3,832 characters in increments of 0001 (pad with zeroes).

See [page 257](#) for detailed instructions on setting this feature.



Select Aztec Code Length 1 Setting

To configure this feature, scan the ENTER/EXIT PROGRAMMING MODE bar code above, then the bar code at left followed by the digits from the Alphanumeric characters in [Appendix D, Keypad](#) representing your desired character(s). End by scanning the ENTER/EXIT bar code again.

Make a mistake? Scan the CANCEL bar code to abort and not save the entry string. You can then start again at the beginning.

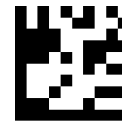

CANCEL

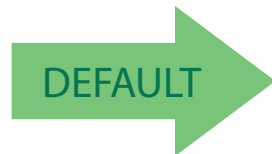

0001 = Length 1 is 1 Character



Aztec Code Set Length 2

This feature specifies one of the bar code lengths for [Aztec Code Length Control on page 204](#). Length 2 is the maximum label length if in Variable Length Mode, or the second fixed length if in Fixed Length Mode. Characters can be set from 0001 to 3,832 characters in increments of 0001 (pad with zeroes).

See [page 258](#) for detailed instructions on setting this feature.



Select Aztec Code Length 2 Setting

To configure this feature, scan the ENTER/EXIT PROGRAMMING MODE bar code above, then the bar code at left followed by the digits from the Alphanumeric characters in [Appendix D, Keypad](#) representing your desired character(s). End by scanning the ENTER/EXIT bar code again.

Make a mistake? Scan the CANCEL bar code to abort and not save the entry string. You can then start again at the beginning.

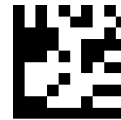

CANCEL

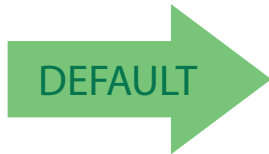

Length 2 is 3,832 Characters

China Sensible Code

China Sensible Code Enable / Disable

Enables/disables the ability of the reader to decode China Sensible Code labels.

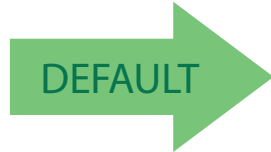

China Sensible Code = Disable



China Sensible Code = Enable

China Sensible Code Length Control

This feature specifies either variable length decoding or fixed length decoding for this symbology.

Variable Length: For variable length decoding, a minimum and maximum length may be set.

Fixed Length: For fixed length decoding, two different lengths may be set.

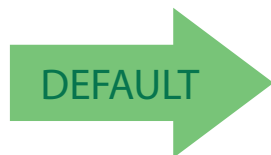

China Sensible Code Length Control = Variable Length



China Sensible Code Length Control = Fixed Length



China Sensible Code Set Length 1

Specifies one of the bar code lengths for **China Sensible Code Length Control** on page 207. Length 1 is the minimum label length if in **Variable Length Mode**, or the first fixed length if in **Fixed Length Mode**. Characters can be set from 0001 to 7,827 characters in increments of 0001 (pad with zeroes).

See page 257 for detailed instructions on setting this feature.



Select China Sensible Code Length 1 Setting

To configure this feature, scan the ENTER/EXIT PROGRAMMING MODE bar code above, then the bar code at left followed by the digits from the Alphanumeric characters in **Appendix D, Keypad** representing your desired character(s). End by scanning the ENTER/EXIT bar code again.

Make a mistake? Scan the CANCEL bar code to abort and not save the entry string. You can then start again at the beginning.

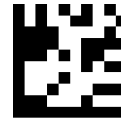

CANCEL

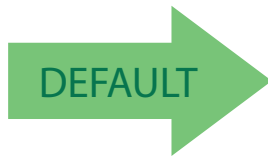

0001 = Length 1 is 1 Character



China Sensible Code Set Length 2

This feature specifies one of the bar code lengths for [China Sensible Code Length Control on page 207](#). Length 2 is the maximum label length if in Variable Length Mode, or the second fixed length if in Fixed Length Mode. Characters can be set from 0001 to 7,827 characters in increments of 0001 (pad with zeroes).

See [page 258](#) for detailed instructions on setting this feature.



Select China Sensible Code Length 2 Setting

To configure this feature, scan the ENTER/EXIT PROGRAMMING MODE bar code above, then the bar code at left followed by the digits from the Alphanumeric characters in [Appendix D, Keypad](#) representing your desired character(s). End by scanning the ENTER/EXIT bar code again.

Make a mistake? Scan the CANCEL bar code to abort and not save the entry string. You can then start again at the beginning.

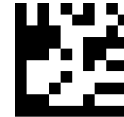

CANCEL



Length 2 is 7,827 Characters



Data Matrix

Data Matrix Enable / Disable

Enables/disables ability of reader to decode Data Matrix labels.



Data Matrix = Disable



Data Matrix = Enable



Data Matrix Square/Rectangular Style

Specifies the options available when reading Data Matrix with different form factors. Choices are:

- Square Style
- Rectangular Style
- Both Square and Rectangular Style

The configuration item can also be configured as a bit mask to filter one or more Data Matrix labels with different symbol size AND shape styles.



Data Matrix Dimensions Mask = Square Style



Data Matrix Dimensions Mask = Rectangular Style

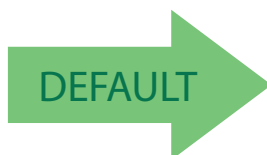

Data Matrix Dimensions Mask = Both Square and Rectangular Style



Data Matrix Length Control

This feature specifies either variable length decoding or fixed length decoding for this symbology.

Variable Length: For variable length decoding, a minimum and maximum length may be set.

Fixed Length: For fixed length decoding, two different lengths may be set.



Data Matrix Length Control = Variable Length



Data Matrix Length Control = Fixed Length

Data Matrix Set Length 1

Specifies one of the bar code lengths for [Data Matrix Length Control](#) on page 211. Length 1 is the minimum label length if in [Variable Length Mode](#), or the first fixed length if in [Fixed Length Mode](#). Characters can be set from 0001 to 3,116 characters in increments of 0001 (pad with zeroes).

See [page 257](#) for detailed instructions on setting this feature.



Select Data Matrix Length 1 Setting

To configure this feature, scan the ENTER/EXIT PROGRAMMING MODE bar code above, then the bar code at left followed by the digits from the Alphanumeric characters in [Appendix D, Keypad](#) representing your desired character(s). End by scanning the ENTER/EXIT bar code again.

Make a mistake? Scan the CANCEL bar code to abort and not save the entry string. You can then start again at the beginning.



CANCEL

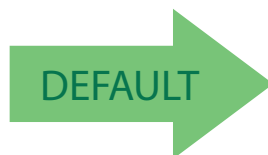

0001 = Length 1 is 1 Character



Data Matrix Set Length 2

This feature specifies one of the bar code lengths for [Data Matrix Length Control on page 211](#). Length 2 is the maximum label length if in Variable Length Mode, or the second fixed length if in Fixed Length Mode. Characters can be set from 0001 to 3,116 characters in increments of 0001 (pad with zeroes).

See [page 258](#) for detailed instructions on setting this feature.



Select Data Matrix Length 2 Setting

To configure this feature, scan the ENTER/EXIT PROGRAMMING MODE bar code above, then the bar code at left followed by the digits from the Alphanumeric characters in [Appendix D, Keypad](#) representing your desired character(s). End by scanning the ENTER/EXIT bar code again.

Make a mistake? Scan the CANCEL bar code to abort and not save the entry string. You can then start again at the beginning.



CANCEL

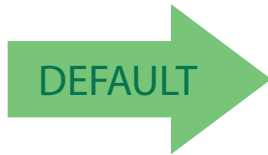

Length 2 is 3,116 Characters

Maxicode

Maxicode Enable / Disable

Enables/disables ability of reader to decode Maxicode labels.

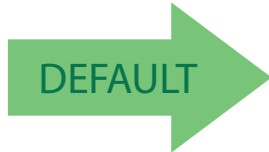

Maxicode = Disable



Maxicode = Enable

Maxicode Primary Message Transmission

Enables/disables the transmission of only the Primary Message when the Secondary Message is not readable.

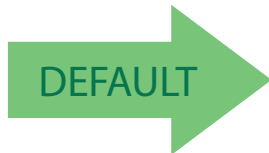

Maxicode Primary Message Transmission = Disable



Maxicode Primary Message Transmission = Enable



Maxicode Length Control

This feature specifies either variable length decoding or fixed length decoding for this symbology.

Variable Length: For variable length decoding, a minimum and maximum length may be set.

Fixed Length: For fixed length decoding, two different lengths may be set.

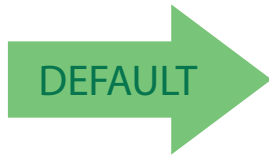

Maxicode Length Control = Variable Length



Maxicode Length Control = Fixed Length

Maxicode Set Length 1

Specifies one of the bar code lengths for [Maxicode Length Control on page 214](#). Length 1 is the minimum label length if in [Variable Length Mode](#), or the first fixed length if in [Fixed Length Mode](#). Characters can be set from 0001 to 0145 characters in increments of 0001 (pad with zeroes).

See [page 257](#) for detailed instructions on setting this feature.



Select Maxicode Length 1 Setting

To configure this feature, scan the ENTER/EXIT PROGRAMMING MODE bar code above, then the bar code at left followed by the digits from the Alphanumeric characters in [Appendix D, Keypad](#) representing your desired character(s). End by scanning the ENTER/EXIT bar code again.

Make a mistake? Scan the CANCEL bar code to abort and not save the entry string. You can then start again at the beginning.

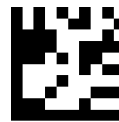

CANCEL

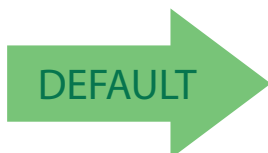

0001 = Length 1 is 1 Character



Maxicode Set Length 2

This feature specifies one of the bar code lengths for [Maxicode Length Control on page 214](#). Length 2 is the maximum label length if in Variable Length Mode, or the second fixed length if in Fixed Length Mode. Characters can be set from 0001 to 0145 characters in increments of 0001 (pad with zeroes).

See [page 258](#) for detailed instructions on setting this feature.



Select Maxicode Length 2 Setting

To configure this feature, scan the ENTER/EXIT PROGRAMMING MODE bar code above, then the bar code at left followed by the digits from the Alphanumeric characters in [Appendix D, Keypad](#) representing your desired character(s). End by scanning the ENTER/EXIT bar code again.

Make a mistake? Scan the CANCEL bar code to abort and not save the entry string. You can then start again at the beginning.

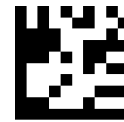

CANCEL

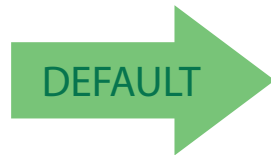

Length 2 is 0145 Characters



PDF417

PDF417 Enable / Disable

Enables/disables the ability of the reader to decode PDF417 labels.



PDF417 = Disable



PDF417 = Enable



PDF417 Length Control

This feature specifies either variable length decoding or fixed length decoding for this symbology.

Variable Length: For variable length decoding, a minimum and maximum length may be set.

Fixed Length: For fixed length decoding, two different lengths may be set.

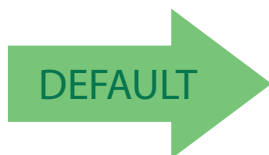

PDF417 Length Control = Variable Length



PDF417 Length Control = Fixed Length



PDF417 Set Length 1

Specifies one of the bar code lengths for PDF417 Length Control on page 216. Length 1 is the minimum label length if in Variable Length Mode, or the first fixed length if in Fixed Length Mode. Length includes the bar code's data characters only. Characters can be set from 0001 to 2,710 characters (pad with zeroes) in increments of 01. Any value greater than 2,710 will be considered to be 2,710.

See [page 257](#) for detailed instructions on setting this feature.



Select PDF417 Length 1 Setting

To configure this feature, scan the ENTER/EXIT PROGRAMMING MODE bar code above, then the bar code at left followed by the digits from the Alphanumeric characters in [Appendix D, Keypad](#) representing your desired character(s). End by scanning the ENTER/EXIT bar code again.

Make a mistake? Scan the CANCEL bar code to abort and not save the entry string. You can then start again at the beginning.



CANCEL

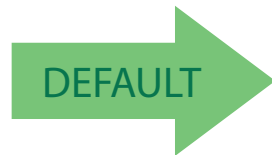

0001 = Length 1 is 1 Character



PDF417 Set Length 2

This feature specifies one of the bar code lengths for [PDF417 Length Control on page 216](#). Length 2 is the maximum label length if in Variable Length Mode, or the second fixed length if in Fixed Length Mode. Length includes the bar code’s check, data, and full-ASCII shift characters. The length does not include start/stop characters. Characters can be set from 01 to 2,710 characters (pad with zeroes) in increments of 01. Any value greater than 2,710 will be considered to be 2,710.

See [page 258](#) for detailed instructions on setting this feature.



Select PDF417 Length 2 Setting

To configure this feature, scan the ENTER/EXIT PROGRAMMING MODE bar code above, then the bar code at left followed by the digits from the Alphanumeric characters in [Appendix D, Keypad](#) representing your desired character(s). End by scanning the ENTER/EXIT bar code again.

Make a mistake? Scan the CANCEL bar code to abort and not save the entry string. You can then start again at the beginning.

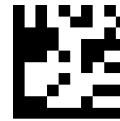

CANCEL

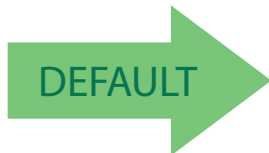

Length 2 is 2,710 Characters

Micro PDF417

Micro PDF417 Enable / Disable

Enables/disables the ability of the reader to decode Micro PDF417 labels.

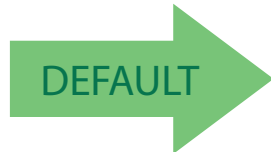

Micro PDF417 = Disable



Micro PDF417 = Enable

Micro PDF417 Code 128 GS1-128 Emulation

Specifies which AIM ID to use for MicroPDF labels when doing Code 128 or GS1-128 emulation.

Emulation choices are:

- Micro PDF AIM ID and label type
- Code 128 / EAN128 AIM Id and label type

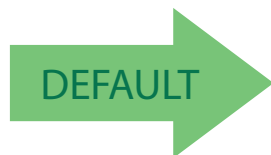

Micro PDF417 Code 128 GS1-128 Emulation =
Micro PDF AIM ID and label type



Micro PDF417 Code 128 GS1-128 Emulation =
Code 128 / EAN128 AIM ID and label type



Micro PDF417 Length Control

This feature specifies either variable length decoding or fixed length decoding for this symbology.

Variable Length: For variable length decoding, a minimum and maximum length may be set.

Fixed Length: For fixed length decoding, two different lengths may be set.

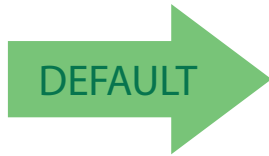

Micro PDF417 Length Control = Variable Length



Micro PDF417 Length Control = Fixed Length

Micro PDF417 Set Length 1

Specifies one of the bar code lengths for [Micro PDF417 Length Control on page 220](#). Length 1 is the minimum label length if in [Variable Length Mode](#), or the first fixed length if in [Fixed Length Mode](#). Length includes the bar code's data characters only. Characters can be set from 0001 to 0366 characters (pad with zeroes) in increments of 01. Any value greater than 0366 will be considered to be 0366.

See [page 257](#) for detailed instructions on setting this feature.



Select Micro PDF417 Length 1 Setting

To configure this feature, scan the ENTER/EXIT PROGRAMMING MODE bar code above, then the bar code at left followed by the digits from the Alphanumeric characters in [Appendix D, Keypad](#) representing your desired character(s). End by scanning the ENTER/EXIT bar code again.

Make a mistake? Scan the CANCEL bar code to abort and not save the entry string. You can then start again at the beginning.

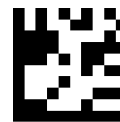

CANCEL

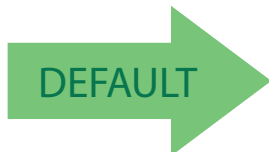

0001 = Length 1 is 1 Character



Micro PDF417 Set Length 2

This feature specifies one of the bar code lengths for [Micro PDF417 Length Control on page 220](#). Length 2 is the maximum label length if in Variable Length Mode, or the second fixed length if in Fixed Length includes the bar code's data characters only. Characters can be set from 0001 to 0366 characters (pad with zeroes) in increments of 01. Any value greater than 0366 will be considered to be 0366.

See [page 258](#) for detailed instructions on setting this feature.



Select Micro PDF417 Length 2 Setting

To configure this feature, scan the ENTER/EXIT PROGRAMMING MODE bar code above, then the bar code at left followed by the digits from the Alphanumeric characters in [Appendix D, Keypad](#) representing your desired character(s). End by scanning the ENTER/EXIT bar code again.

Make a mistake? Scan the CANCEL bar code to abort and not save the entry string. You can then start again at the beginning.



CANCEL

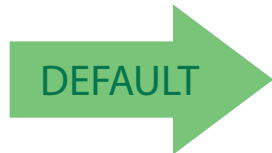

Length 2 is 0366 Characters



QR Code

QR Code Enable / Disable

Enables/disables the ability of the reader to decode QR Code labels.



QR Code Length Control

This feature specifies either variable length decoding or fixed length decoding for this symbology.

Variable Length: For variable length decoding, a minimum and maximum length may be set.

Fixed Length: For fixed length decoding, two different lengths may be set.

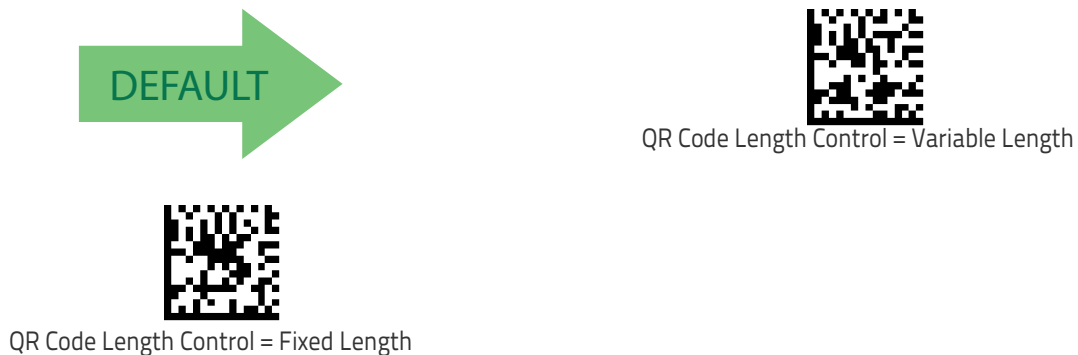



QR Code Set Length 1

Specifies one of the bar code lengths for [QR Code Length Control on page 222](#). Length 1 is the minimum label length if in [Variable Length Mode](#), or the first fixed length if in [Fixed Length Mode](#). Characters can be set from 0001 to 7,089 characters in increments of 0001 (pad with zeroes).

See [page 257](#) for detailed instructions on setting this feature.



Select QR Code Length 1 Setting

To configure this feature, scan the ENTER/EXIT PROGRAMMING MODE bar code above, then the bar code at left followed by the digits from the Alphanumeric characters in [Appendix D, Keypad](#) representing your desired character(s). End by scanning the ENTER/EXIT bar code again.

Make a mistake? Scan the CANCEL bar code to abort and not save the entry string. You can then start again at the beginning.



CANCEL

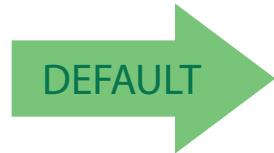

0001 = Length 1 is 1 Character



QR Code Set Length 2

This feature specifies one of the bar code lengths for [QR Code Length Control on page 222](#). Length 2 is the maximum label length if in Variable Length Mode, or the second fixed length if in Fixed Length Mode. Characters can be set from 0001 to 7,089 characters in increments of 0001 (pad with zeroes).

See [page 258](#) for detailed instructions on setting this feature.



Select QR Code Length 2 Setting

To configure this feature, scan the ENTER/EXIT PROGRAMMING MODE bar code above, then the bar code at left followed by the digits from the Alphanumeric characters in [Appendix D, Keypad](#) representing your desired character(s). End by scanning the ENTER/EXIT bar code again.

Make a mistake? Scan the CANCEL bar code to abort and not save the entry string. You can then start again at the beginning.

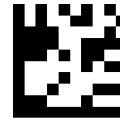

CANCEL

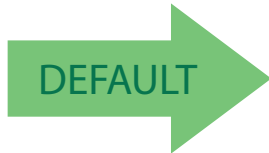

Length 2 is 7,089 Characters

Micro QR Code

Micro QR Code Enable/Disable

Enables/disables the ability of the reader to decode Micro QR Code labels.

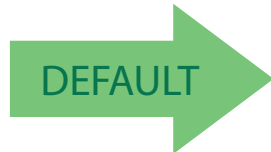

Micro QR Code = Disable



Micro QR Code = Enable

Micro QR Code Length Control

This feature specifies either variable length decoding or fixed length decoding for this symbology.

Variable Length: For variable length decoding, a minimum and maximum length may be set.

Fixed Length: For fixed length decoding, two different lengths may be set.

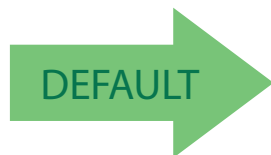

Micro QR Code Length Control = Variable Length



Micro QR Code Length Control = Fixed Length



Micro QR Code Set Length 1

Specifies one of the bar code lengths for [Micro QR Code Length Control on page 225](#). Length 1 is the minimum label length if in [Variable Length Mode](#), or the first fixed length if in [Fixed Length Mode](#). Characters can be set from 0001 to 0035 characters in increments of 0001 (pad with zeroes).

See [page 257](#) for detailed instructions on setting this feature.



Select Micro QR Code Length 1 Setting

To configure this feature, scan the ENTER/EXIT PROGRAMMING MODE bar code above, then the bar code at left followed by the digits from the [Alphanumeric characters in Appendix D, Keypad](#) representing your desired character(s). End by scanning the ENTER/EXIT bar code again.

Make a mistake? Scan the CANCEL bar code to abort and not save the entry string. You can then start again at the beginning.

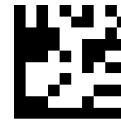

CANCEL

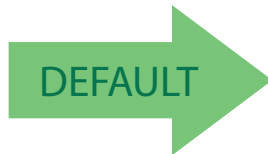

0001 = Length 1 is 1 Character



Micro QR Code Set Length 2

This feature specifies one of the bar code lengths for [Micro QR Code Length Control on page 225](#). Length 2 is the maximum label length if in Variable Length Mode, or the second fixed length if in Fixed Length Mode. Characters can be set from 0001 to 0035 characters in increments of 0001 (pad with zeroes).

See [page 258](#) for detailed instructions on setting this feature.



Select QR Code Length 2 Setting

To configure this feature, scan the ENTER/EXIT PROGRAMMING MODE bar code above, then the bar code at left followed by the digits from the Alphanumeric characters in [Appendix D, Keypad](#) representing your desired character(s). End by scanning the ENTER/EXIT bar code again.

Make a mistake? Scan the CANCEL bar code to abort and not save the entry string. You can then start again at the beginning.



CANCEL

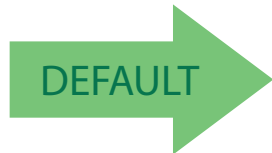

Length 2 is 0035 Characters



UCC Composite

UCC Optional Composite Timer

Specifies the amount of time the system will wait for the stacked part of a UCC Composite label before transmitting the linear label without an add-on.

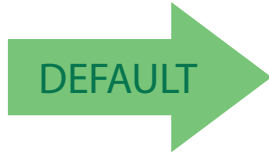

UCC Optional Composite Timer = Timer Disabled



UCC Optional Composite Timer = 100msec



UCC Optional Composite Timer = 200msec



UCC Optional Composite Timer = 300msec



UCC Optional Composite Timer = 400msec



UCC Optional Composite Timer = 500msec



Postal Code Selection

Enables/disables the ability of the scanner to decode labels of a specific postal symbology.

- Disable All Postal Codes
- Postnet
- Planet
- Royal Mail
- Kix
- Australia Post
- Japan Post
- IMB
- Sweden Post
- Portugal Post

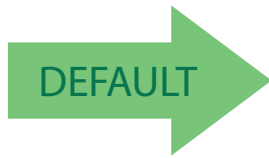

Postal Code Selection = Disable All Postal Codes



Postal Code Selection = Enable Postnet



Postal Code Selection = Enable Planet



Postal Code Selection = Enable Royal Mail



Postal Code Selection = Enable Kix



Postal Code Selection = Enable Australia Post



Postal Code Selection (continued)



Postal Code Selection = Enable Japan Post

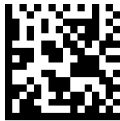

Postal Code Selection = Enable IMB



Postal Code Selection = Enable Sweden Post



Postal Code Selection = Enable Portugal Post

Postnet BB Control

Controls the ability of the scanner to decode B and B' fields of Postnet labels.

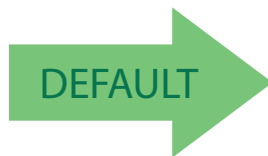

Postnet BB Control = Disable



Postnet BB Control = Enable

Motion Features

MOTION AIMING CONTROL on page 231
MOTION SENSITIVITY on page 232
MOTIONLESS TIMEOUT on page 233

Use this chapter to configure motion settings for the handheld.
Reference [Appendix B](#), for a listing of standard factory settings.

Motion Aiming Control

Configures the ability of the scanner to Enable/Disable the Aiming system when motion is detected.



Motion Aiming Control = Disable



Motion Aiming Control = Enable





Enter/Exit Programming Mode

Motion Sensitivity

Defines discrete set of levels for scanner motion sensitivity when in handheld use.

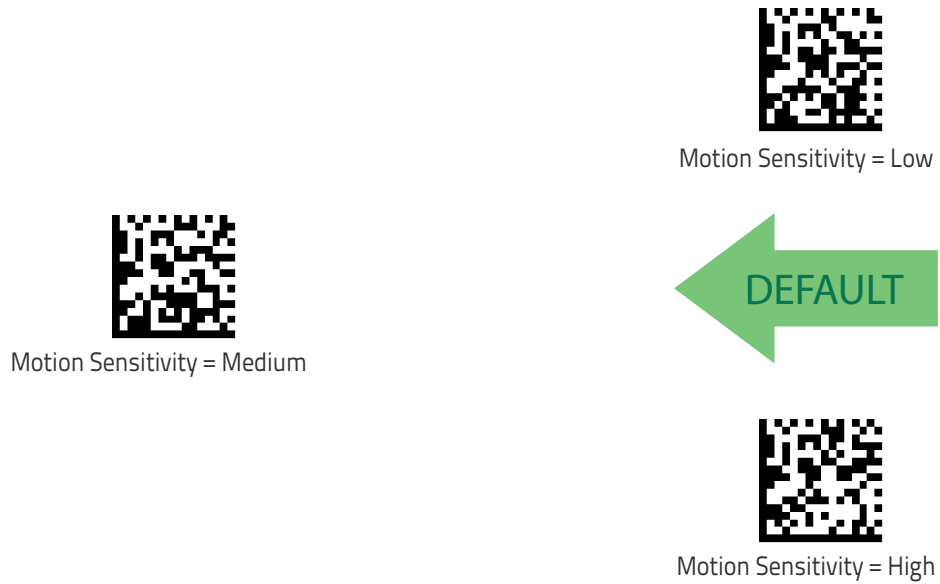

Motionless Timeout

Specifies the waiting time in 100 millisecond ticks to assume that the reader is in a motionless condition. The selectable range is 500 msec to 25.5 Seconds. When no motion event is detected for a period of time longer than this timeout, the software assumes the reader is in a motionless condition. This normally results in returning the scanner to Stand Mode. This option relates to such features as Aimer On and Stand Mode Object Sense scanning with respect to motion.

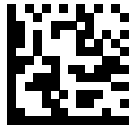

Select Motionless Timeout Setting

To configure this feature, scan the ENTER/EXIT PROGRAMMING MODE bar code above, then the bar code at left followed by three digits from the Alphanumeric characters in [Appendix D, Keypad](#) representing your desired character(s). End by scanning the ENTER/EXIT bar code again.

Make a mistake? Scan the CANCEL bar code to abort and not save the entry string. You can then start again at the beginning.

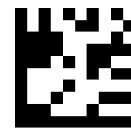

CANCEL

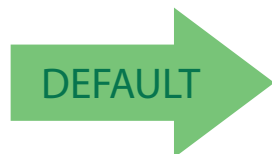

020 = Motionless Timeout = 2 seconds

NOTES



Chapter 4 References

This section contains explanations and examples of selected bar code features. See "Configuration Using Bar Codes" starting on page 19 for the actual bar code labels used to configure the scanner.

RS-232 PARAMETERS on page 234 <ul style="list-style-type: none">▪ RS-232 Only on page 234▪ RS-232/USB COM Parameters on page 235
KEYBOARD INTERFACE on page 242 <ul style="list-style-type: none">▪ Wedge Quiet Interval on page 242▪ Intercharacter Delay on page 243▪ Intercode Delay on page 244
DATA FORMAT on page 245 <ul style="list-style-type: none">▪ Data Editing on page 245▪ Global Prefix/Suffix on page 246▪ Global AIM ID on page 247▪ Label ID on page 248▪ Character Conversion on page 252
SCANNING FEATURES on page 253 <ul style="list-style-type: none">▪ Scanning Features on page 253
SCANNING FEATURES on page 253 <ul style="list-style-type: none">▪ Scan Mode on page 253▪ Scanning Active Time on page 254▪ Flash On Time on page 255▪ Flash Off Time on page 256
SYMBOLOGIES on page 257 <ul style="list-style-type: none">▪ Set Length on page 257▪ Set Length on page 257

RS-232 Parameters

RS-232 Only

Baud Rate

Baud rate is the number of bits of data transmitted per second. Set the scanner's baud rate to match the baud rate setting of the host device. With an improper baud rate setting, data may not reach the host correctly.

Data Bits

This parameter allows the reader to interface with devices requiring a 7-bit or 8-bit ASCII protocol for sending and receiving data.

Stop Bits

The stop bit(s) at the end of each transmitted character marks the end of transmission of one character and prepares the receiving device for the next character in the serial data stream. The number of stop bits selected (one or two) depends on the number the receiving terminal is programmed to accommodate. Set the number of stop bits to match host device requirements.

Parity

This feature specifies parity required for sending and receiving data. A parity check bit is the most significant bit of each ASCII coded character. Select the parity type according to host device requirements.

- Select None when no parity bit is required.
- Select Odd parity and the parity bit value is set to 0 or 1, based on data, to ensure that an odd number of 1 bits are contained in the coded character.
- Select Even parity and the parity bit value is set to 0 or 1, based on data, to ensure that an even number of 1 bits are contained in the coded character.

Handshaking Control

The data interface consists of an RS-232 port designed to operate either with or without the hardware handshaking lines, Request to Send (RTS), and Clear to Send (CTS). Handshaking Control includes the following options:

- RTS — RTS is asserted during transmissions. CTS is ignored.
- RTS/CTS — RTS is asserted during transmissions. CTS gates transmissions.
- RTS/XON/XOFF — RTS is asserted during transmissions. CTS is ignored. XON and XOFF gate transmissions.
- RTS On/CTS — RTS is always asserted. CTS gates transmissions.
- RTS/CTS Scan Control — RTS is asserted during transmissions. CTS gates transmissions and controls enable and disable state of scanner.

RS-232/USB COM Parameters

Intercharacter Delay

This parameter specifies the intercharacter delay between the end of one character and the beginning of the next. The delay can be set within a range of zero (0) to 990 milliseconds in 10ms increments. A setting of zero specifies no delay.

To set the delay:

1. Determine the desired setting in milliseconds.
2. Divide the desired setting by 10 (setting is in 10ms increments). Pad the result with leading zeroes to yield two digits. For example: 0 = 00, 5 = 05, 20 = 20, etc.
3. Scan the ENTER/EXIT PROGRAMMING MODE bar code to enter Programming Mode.
4. Go to [page 28](#) and scan the bar code: SELECT INTERCHARACTER DELAY SETTING.
5. Scan the appropriate two digits from the keypad in [Appendix D, Keypad](#), that represent the duration which was determined in the steps above. You will hear a two-beep indication after the last character.



NOTE

If you make a mistake before the last character, scan the CANCEL bar code to abort and not save the entry string. You can then start again at the beginning.

6. Scan the ENTER/EXIT PROGRAMMING MODE bar code to exit.

This completes the procedure. See the following table for examples of how to set this feature.

Table 2. Intercharacter Delay Setting Examples

STEP	ACTION	EXAMPLES			
1	Desired Setting	50ms	150ms	600ms	850ms
2	Divide by 10 (pad with leading zeroes to yield two-digits)	05	15	60	85
3	Scan ENTER/EXIT PROGRAMMING MODE				
4	Scan SELECT INTERCHARACTER DELAY SETTING				
5	Scan Two Characters From Appendix D, Keypad	'0' and '5'	'1' and '5'	'6' and '0'	'8' and '5'
6	Scan ENTER/EXIT PROGRAMMING MODE				

ACK NAK Options

This enables/disables the ability of the scanner to support the RS-232 ACK/NAK protocol. When configured, the scanner and/or host sends an “ACK” when it receives data properly, and sends “NAK” when the data is in error.

Options are:

- Disable
- Enable for label transmission — The scanner expects an ACK/NAK response from the host when a label is sent
- Enable for host-command acknowledge — The scanner will respond with ACK/NAK when the host sends a command
- Enable for label transmission and host-command acknowledge

ACK Character

This setting specifies an ASCII character or hex value to be used as the ACK character. ASCII characters or any hex value from 0 to 0xFF can be selected.



NOTE

Setting to previously defined characters such as XON, XOFF, or host commands conflicts with normal operation of these characters. 8-bit data is not recognized when the option Data Bits on page 24 has been set as 7 Data Bits.

1. Determine the desired character or value.
 2. Use the [ASCII Chart on page 293](#) on the inside back cover of this manual to find the hex equivalent for the desired character/value.
 3. Go to [page 31](#) and scan ENTER/EXIT PROGRAMMING MODE to enter Programming Mode.
 4. Scan the bar code: SELECT ACK CHARACTER SETTING.
 5. Scan the appropriate two alphanumeric characters from the keypad in [Appendix D, Keypad](#), that represent the desired character/value determined above. The second character will cause a two-beep indication.
 6. Scan the ENTER/EXIT PROGRAMMING MODE bar code to exit.
- See the table below for examples of how to set this feature.

Table 3. ACK Character Setting Examples

STEP	ACTION	EXAMPLES			
1	Desired Character/Value	ACK	\$	@	>
2	Hex equivalent from ASCII Chart on page 293	0x06	0x24	0x40	0x3E
3	Scan ENTER/EXIT PROGRAMMING MODE				
4	Scan SELECT ACK CHARACTER SETTING				
5	Scan Two Characters from Appendix D, Keypad	'0' and '6'	'2' and '4'	'4' and '0'	'3' AND 'E'
6	Scan ENTER/EXIT PROGRAMMING MODE				

NAK Character

This setting specifies an ASCII character or hex value to be used as the NAK character. ASCII characters or any hex value from 0 to 0xFF can be selected.



NOTE

Setting to previously defined characters such as XON, XOFF, or host commands conflicts with normal operation of these characters. 8-bit data is not recognized when the option Data Bits on page 24 has been set as 7 Data Bits.

To set this feature:

1. Determine the desired character or value.
2. Use the [ASCII Chart on page 293](#) on the inside back cover of this manual to find the hex equivalent for the desired character/value.
3. Scan the ENTER/EXIT PROGRAMMING MODE bar code to enter Programming Mode.
4. Scan the bar code: SELECT NAK CHARACTER SETTING.
5. Scan the appropriate two alpha-numeric characters from the keypad in [Appendix D, Keypad](#), that represent the desired character/value determined above. The second character will cause a two-beep indication.
6. Scan the ENTER/EXIT PROGRAMMING MODE bar code to exit Programming Mode.

This completes the procedure. See the table below for examples of how to set this feature.

Table 4. NAK Character Setting Examples

STEP	ACTION	EXAMPLES			
1	Desired Character/Value	NAK	\$	@	>
2	Hex equivalent	0x15	0x24	0x40	0x3E
3	Scan ENTER/EXIT PROGRAMMING MODE				
4	Scan SELECT NAK CHARACTER SETTING				
5	Scan Two Characters From Appendix D, Keypad	'1' and '5'	'2' and '4'	'4' and '0'	'3' AND 'E'
6	Scan ENTER/EXIT PROGRAMMING MODE				

ACK NAK Timeout Value

This option specifies the amount of time the scanner waits for an ACK character from the host following label transmission. The selectable timeout range is 200 milliseconds to 15,000ms (15 seconds) in 200ms increments. A selection of 0 disables the timeout.

To set this value:

1. Determine the desired setting in milliseconds.
2. Divide the desired setting by 200 (setting is in 200ms increments). Pad the result with leading zeroes to yield two digits. For example: 0 = 00, 5 = 05, 20 = 20, etc.
3. Go to [page 32](#) and scan the ENTER/EXIT PROGRAMMING MODE bar code to enter Programming Mode.
4. Scan the bar code: SELECT ACK NAK TIMEOUT VALUE SETTING.
5. Scan the appropriate two digits from the keypad in [Appendix D, Keypad](#), that represent the duration which was determined in the steps above. You will hear a two-beep indication after the last character.



NOTE

If you make a mistake before the last character, scan the CANCEL bar code to abort and not save the entry string. You can then start again at the beginning.

6. Scan the ENTER/EXIT PROGRAMMING MODE bar code to exit Programming Mode.

This completes the procedure. See the table below for examples of how to set this feature.

Table 5. ACK NAK Timeout Value Setting Examples

STEP	ACTION	EXAMPLES			
1	Desired Setting	200ms	1,000ms (1 sec.)	5200ms (5.2 sec.)	15,000ms (15 sec.)
2	Divide by 200	01	05	26	75
3	Scan ENTER/EXIT PROGRAMMING MODE				
4	Scan SELECT ACK NAK TIMEOUT VALUE SETTING				
5	Scan Two Characters From Appendix D, Keypad	'0' and '1'	'0' and '5'	'2' and '6'	'7' and '5'
6	Scan ENTER/EXIT PROGRAMMING MODE				

ACK NAK Retry Count

This feature specifies the number of times the scanner retries a label transmission due to a retry condition. The selectable range is from 1 to 254 retries. A selection of 0 disables the count, and a selection of 255 specifies unlimited retries.

To set this feature:

1. Determine the desired setting.
2. Pad the number with leading zeroes to yield three digits. For example: 0 = 000, 5 = 005, 20 = 020, etc.
3. Go to [page 33](#) and scan the ENTER/EXIT PROGRAMMING MODE bar code to enter Programming Mode.
4. Scan the bar code: SELECT ACK NAK RETRY COUNT SETTING.
5. Scan the appropriate three digits from the keypad in [Appendix D, Keypad](#), that represent the number which was determined in the steps above. You will hear a two-beep indication after the last character.



NOTE

If you make a mistake before the last character, scan the CANCEL bar code to abort and not save the entry string. You can then start again at the beginning.

6. Scan the ENTER/EXIT PROGRAMMING MODE bar code to exit Programming Mode.

This completes the procedure. See the table below for examples of how to set this feature.

Table 6. ACK NAK Retry Count Setting Examples

STEP	ACTION	EXAMPLES			
1	Desired Setting	Disable Retry Count	3 Retries	54 Retries	Unlimited Retries
2	Pad with leading zero(es)	000	003	054	255
3	Scan ENTER/EXIT PROGRAMMING MODE				
4	Scan SELECT ACK NAK RETRY COUNT SETTING				
5	Scan Three Characters From Appendix D, Keypad	'0', '0' and '0'	'0', '0' and '3'	'0', '5' and '4'	'2', '5' and '5'
6	Scan ENTER/EXIT PROGRAMMING MODE				

Disable Character

Specifies the value of the RS-232 host command used to disable the scanner. ASCII characters or any hex value from 0 to 0xFF can be selected.



NOTE

Setting to previously defined characters such as XON, XOFF, or host commands conflicts with normal operation of these characters. 8-bit data is not recognized when the option Data Bits on page 24 has been set as 7 Data Bits.

To set the value:

1. Determine the desired character or value. A setting of 0xFF indicates the Disable Character is not used (not available).
2. Use the [ASCII Chart on page 293](#) on the inside back cover of this manual to find the hex equivalent for the desired character/value.
3. Go to [page 35](#) and scan the ENTER/EXIT PROGRAMMING MODE bar code to enter Programming Mode.
4. Scan the bar code: SELECT DISABLE CHARACTER SETTING on [page 35](#).
5. Scan the appropriate two alphanumeric characters from the keypad in [Appendix D, Keypad](#), that represent the desired character/value determined above. The second character will cause a two-beep indication.
6. Scan the ENTER/EXIT PROGRAMMING MODE bar code to exit Programming Mode.

This completes the procedure. See the table below for examples of how to set this feature.

Table 7. Disable Character Setting Examples

STEP	ACTION	EXAMPLES			
1	Desired character/value	'd'	'y'	'D'	Disable Command Not Used
2	Hex equivalent from ASCII Chart on page 293	0x64	0x7D	0x44	0xFF
3	Scan ENTER/EXIT PROGRAMMING MODE				
4	Scan SELECT DISABLE CHARACTER VALUE SETTING				
5	Scan Two Characters From Appendix D, Keypad	'6' and '4'	'7' and 'D'	'4' and '4'	'F' and 'F'
6	Scan ENTER/EXIT PROGRAMMING MODE				

Enable Character

Specifies the value of the RS-232 host command used to enable the scanner. ASCII characters or any hex value from 0 to 0xFF can be selected.



NOTE

Setting to previously defined characters such as XON, XOFF, or host commands conflicts with normal operation of these characters. 8-bit data is not recognized when the option Data Bits on page 24 has been set as 7 Data Bits.

To set this feature:

Determine the desired character or value. A setting of 0xFF indicates the Enable Character is not used (not available).

1. Determine the desired character or value.
2. Use the [ASCII Chart on page 293](#) on the inside back cover of this manual to find the hex equivalent for the desired character/value.
3. Go to [page 36](#) and scan the ENTER/EXIT PROGRAMMING MODE bar code to enter Programming Mode.
4. Scan the bar code: SELECT ENABLE CHARACTER SETTING on [page 36](#).
5. Scan the appropriate two alphanumeric characters from the keypad in [Appendix D, Keypad](#), that represent the desired character/value determined above. The second character will cause a two-beep indication.
6. Scan the ENTER/EXIT PROGRAMMING MODE bar code to exit Programming Mode.

This completes the procedure. See the table below for examples of how to set this feature.

Table 8. Enable Character Setting Examples

STEP	ACTION	EXAMPLES			
1	Desired character/value	'e'	'}'	'E'	Enable Command Not Used
2	Hex equivalent from ASCII Chart on page 293	0x65	0x7D	0x45	0xFF
3	Scan ENTER/EXIT PROGRAMMING MODE				
4	Scan SELECT ENABLE CHARACTER SETTING				
5	Scan Two Characters From Appendix D, Keypad	'6' and '5'	'7' and 'D'	'4' and '5'	'F' and 'F'
6	Scan ENTER/EXIT PROGRAMMING MODE				

Keyboard Interface

Wedge Quiet Interval

Specifies the amount of time the scanner looks for keyboard activity before it breaks the keyboard connection in order to transmit data to host. The range is from 0 to 990ms in 10ms increments.



This feature applies **ONLY** to the Keyboard Wedge interface.

NOTE

1. Determine the desired setting in milliseconds.
2. Divide the desired setting by 10 (setting is in 10ms increments). Pad the result with leading zeroes to yield two digits. For example: 0 = 00, 5 = 05, 20 = 20, etc.
3. Go to [page 64](#) and scan the ENTER/EXIT PROGRAMMING MODE bar code to enter Prog. Mode.
4. Scan the bar code: SELECT WEDGE QUIET INTERVAL SETTING on [page 64](#).
5. Scan the appropriate two digits from the keypad in [Appendix D, Keypad](#), that represent the duration which was determined in the steps above. You will hear a two-beep indication after the last character.



If you make a mistake before the last character, scan the **CANCEL** bar code to abort and not save the entry string. You can then start again at the beginning.

NOTE

6. Scan the ENTER/EXIT PROGRAMMING MODE bar code to exit.

This completes the procedure to set the Wedge Quiet Interval. See the table below for examples of how to set this feature.

Table 9. Wedge Quiet Interval Setting Examples

STEP	ACTION	EXAMPLES			
1	Desired Setting	10ms	150ms	600ms	850ms
2	Divide by 10 (and pad with leading zeroes)	01	15	60	85
3	Scan ENTER/EXIT PROGRAMMING MODE				
4	Scan SELECT WEDGE QUIET INTERVAL SETTING				
5	Scan Two Characters From Appendix D, Keypad	'0' and '1'	'1' and '5'	'6' and '0'	'8' and '5'
6	Scan ENTER/EXIT PROGRAMMING MODE				

Intercharacter Delay

This parameter specifies the intercharacter delay between the end of one character and the beginning of the next. The delay can be set within a range of zero (0) to 990 milliseconds in 10ms increments. A setting of zero specifies no delay.



This feature applies **ONLY** to the Keyboard Wedge interface.

NOTE

To set the delay:

1. Determine the desired setting in milliseconds.
2. Divide the desired setting by 10 (setting is in 10ms increments). Pad the result with leading zeroes to yield two digits. For example: 0 = 00, 5 = 05, 20 = 20, etc.
3. Go to [page 65](#) and scan the ENTER/EXIT PROGRAMMING MODE bar code to enter Programming Mode.
4. Scan the bar code: SELECT INTERCHARACTER DELAY SETTING on [page 65](#).
5. Scan the appropriate two digits from the keypad in [Appendix D, Keypad](#), that represent the duration which was determined in the steps above. You will hear a two-beep indication after the last character.



If you make a mistake before the last character, scan the **CANCEL** bar code to abort and not save the entry string. You can then start again at the beginning.

NOTE

6. Scan the ENTER/EXIT PROGRAMMING MODE bar code to exit Programming Mode.

This completes the procedure. See the table below for examples of how to set this feature.

Table 10. Intercharacter Delay Setting Examples

STEP	ACTION	EXAMPLES			
1	Desired Setting	50ms	150ms	600ms	850ms
2	Divide by 10 (and pad with leading zeroes to yield two-digits)	05	15	60	85
3	Scan ENTER/EXIT PROGRAMMING MODE				
4	Scan SELECT INTERCHARACTER DELAY SETTING				
5	Scan Two Characters From Appendix D, Keypad	'0' and '5'	'1' and '5'	'6' and '0'	'8' and '5'
6	Scan ENTER/EXIT PROGRAMMING MODE				

Intercode Delay

Specifies the delay between labels transmitted to the host for this interface. The selectable range for this feature is from 0 to 99 seconds.

Follow these instructions to set this feature:

1. Determine the desired setting.
2. Pad the number with leading zeroes to yield two digits. For example: 0 = 00, 5 = 05, 20 = 20, etc
3. Go to [page 66](#) and scan the ENTER/EXIT PROGRAMMING MODE bar code to enter Programming Mode.
4. Scan the bar code: SELECT INTERCODE DELAY SETTING on [page 66](#).
5. Scan the appropriate two digits from the keypad in [Appendix D, Keypad](#), that represent the duration which was determined in the steps above. You will hear a two-beep indication after the last character.



NOTE

If you make a mistake before the last character, scan the CANCEL bar code to abort and not save the entry string. You can then start again at the beginning.

6. Scan the ENTER/EXIT PROGRAMMING MODE bar code to exit Programming Mode.

This completes the procedure. See the table below for examples of how to set this feature.

Table 11. Wedge Intercode Delay Examples

STEP	ACTION	EXAMPLES			
1	Desired Setting	No Delay	5 Seconds	60 Seconds	99 Seconds
2	Pad with leading zero(es)	00	05	60	99
3	Scan ENTER/EXIT PROGRAMMING MODE				
4	Scan SELECT INTERCODE DELAY SETTING				
5	Scan Two Characters From Appendix D, Keypad	'0' and '0'	'0' and '5'	'6' and '0'	'9' and '9'
6	Scan ENTER/EXIT PROGRAMMING MODE				

Data Format

Data Editing

When a bar code is scanned, additional information can be sent to the host computer along with the bar code data. This combination of bar code data and supplementary user-defined data is called a “message string.” The Data Editing features can be used to build specific user-defined data into a message string. There are several types of selectable data characters that can be sent before and after scanned data. You can specify if they should be sent with all symbologies, or only with specific symbologies. The following shows the available elements you can add to a message string:

Figure 5. Breakdown of a Message String

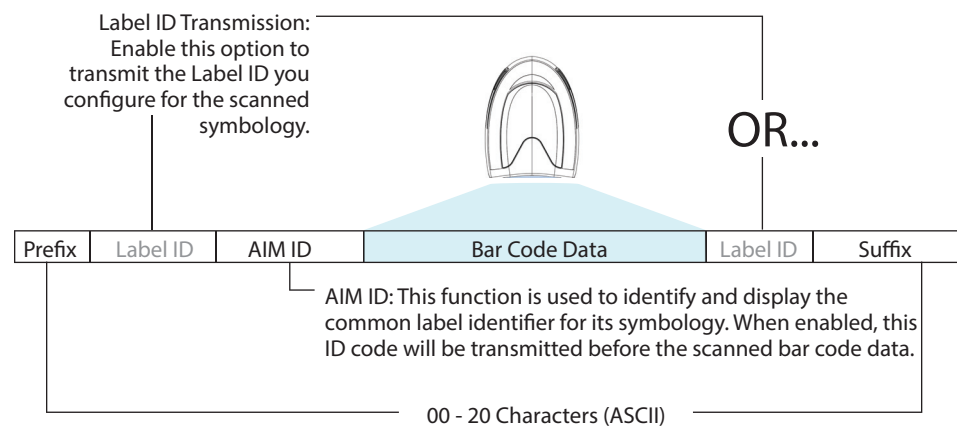

NOTE

Additional advanced editing is available. See the Advanced formatting features in the Datalogic Aladdin configuration software, or contact Technical Support (see page 3) for more information.

Please Keep In Mind...

- Modifying a message string is not a mandatory requirement. Data editing is a sophisticated feature allowing highly customizable output for advanced users. Factory default settings for data editing is typically set to NONE.
- A prefix or suffix may be applied only to a specified symbology (reference [1D Symbologies](#), starting on page 113) or across all symbologies (set via the Global features in [Configuration Using Bar Codes](#), starting on page 19).
- You can add any character from the [ASCII Chart](#) on page 293 (from 00–FF) on the inside back cover of this manual as a prefix, suffix or Label ID.
- Enter prefixes and suffixes in the order in which you want them to appear on the output.

Global Prefix/Suffix

Up to 20 ASCII characters may be added as a prefix (in a position before the bar code data) and/or as a suffix (in a position following the bar code data) as indicated.

Figure 6. Prefix and Suffix Positions

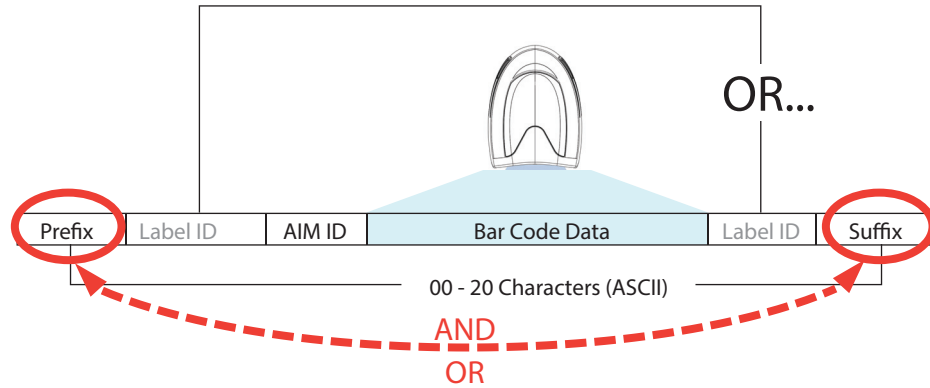

Example: Setting a Prefix

In this example, we'll set a prefix for all symbologies.

1. Determine which ASCII character(s) are to be added to scanned bar code data. In this example, we'll add a dollar sign ('\$') as a prefix.
2. Go to [page 76](#) and scan the ENTER/EXIT PROGRAMMING MODE bar code, then scan the SET GLOBAL PREFIX bar code.
3. Reference the [ASCII Chart on page 293](#) on the inside back cover of this manual to find the hex value assigned to the desired character. The corresponding hex number for the '\$' character is 24. To enter this selection code, scan the '2' and '4' bar codes from [Appendix D, Keypad](#).



NOTE

If you make a mistake before the last character, scan the CANCEL bar code to abort and not save the entry string. You can then start again at the beginning.

4. If less than the expected string of 20 characters are selected, scan the ENTER/EXIT bar code to terminate the string.
5. Scan the ENTER/EXIT bar code once again to exit Programming Mode.
6. The resulting message string would appear as follows:
Scanned bar code data: **NPQR**
Resulting message string output: **ANPQR**

Global AIM ID



This feature enables/disables addition of AIM IDs for all symbology types.

NOTE

AIM label identifiers (as opposed to custom characters you select yourself as with label identifiers) can be included with scanned bar code data. AIM label identifiers consist of three characters as follows:

- A close brace character (ASCII ‘}’), followed by...
- A code character (see the table below), followed by...
- A modifier character (the modifier character is symbol dependent).

SYMBOLGY	CHAR	SYMBOLGY	CHAR
UPC/EAN	E ^a	Code 128/GS1-128	C
Code 39 and Code 32	A	DataBar Omnidirectional, DataBar Expanded	e
Codabar	F	Standard 2 of 5	S
Interleaved 2 of 5	I	ISBN	X ^b
Code 93	G	Code 11	H

- UPC-A and UPC-E labels are converted to EAN 13 when adding AIM IDs.
- ISBN (X with a 0 modifier character)

Figure 7. AIM ID

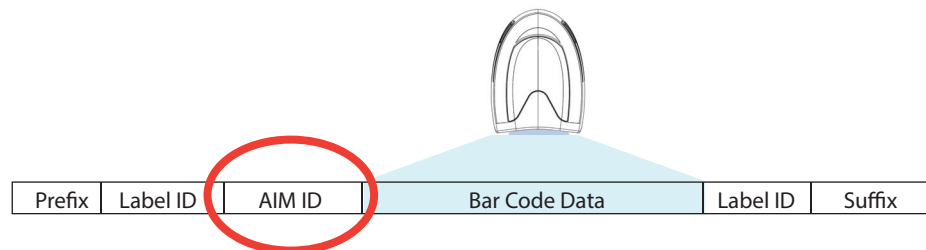

Label ID

A Label ID is a customizable code of up to three ASCII characters (each can be one of hex 0x01–0xFF), used to identify a bar code (symbology) type. It can be appended previous to or following the transmitted bar code data depending upon how this option is enabled. This feature provides options for configuring custom Label IDs as a pre-loaded set or individually per symbology (see "Label ID: Set Individually Per Symbology" on page 79). If you wish to program the scanner to always include an industry standard label identifier for ALL symbology types, see "Global AIM ID" on page 77.

Label ID: Pre-loaded Sets

The following table lists the pre-loaded label ID sets for the USA and Europe.

Table 12. Label ID Pre-loaded Sets

Symbology	USA Label ID set		EU Label ID set	
	ASCII character	Hex value	ASCII character	Hexadecimal value
ABC Codabar	S	530000	S	530000
CODABAR	%	250000	R	520000
Code 39 CIP	Y	590000	Y	590000
Code 93	&	260000	U	550000
CODE11	CE	434500	b	620000
CODE128	#	230000	T	540000
CODE32	A	410000	X	580000
CODE39	*	2A0000	V	560000
CODE4	4	340000	4	340000
CODE5	j	6A0000	j	6A0000
CODE93	&	260000	U	550000
DATALOGIC 20F5	s	730000	s	730000
EAN13	F	460000	B	420000
EAN13 P2	F	460000	L	4C0000
EAN13 P5	F	460000	M	4D0000
EAN8	FF	464600	A	410000
EAN8 P2	FF	464600	J	4A0000
EAN8 P5	FF	464600	K	4B0000
FOLLETT 20F5	O	4F0000	O	4F0000
GS1 DATABAR EXPANDED	RX	525800	t	740000
GS1 DATABAR LIMITED	RL	524C00	v	760000

Symbology	USA Label ID set		EU Label ID set	
GS1 DATABAR OMNIDIRECTIONAL	R4	523400	u	750000
GS1-128		000000	k	6B0000
I2OF5	i	690000	N	4E0000
IATA	IA	494100	&	260000
Industrial 2 of 5	W	570000	W	570000
Interleaved 2 of 5 CIP HR	e	650000	e	650000
ISBN	l	490000	@	400000
ISBT128	f	660000	f	660000
ISSN	n	6E0000	n	6E0000
MSI	@	400000	Z	5A0000
S25	s	730000	P	500000
UPCA	A	410000	C	430000
UPCA P2	A	410000	F	460000
UPCA P5	A	410000	G	470000
UPCE	E	450000	D	440000
UPCE P2	E	450000	H	480000
UPCE P5	E	450000	I	490000

Label ID: Set Individually Per Symbology

To configure a Label ID individually for a single symbology:

1. Scan the ENTER/EXIT bar code.
2. Select Label ID position as either BEFORE (Enable as Prefix) or AFTER (Enable as suffix) by scanning the appropriate bar code in the section "Label ID Control" on page 79. Reference Figure 8 for Label ID positioning options if multiple identification features are enabled.
3. Scan a bar code to select the symbology for which you wish to configure a custom Label ID from the section [Label ID Symbology Selection, starting on page 80](#).
4. Determine the desired character(s) (you may choose up to three) which will represent the Label ID for the selected symbology.
5. Turn to the [ASCII Chart on page 293](#) on the inside back cover of this manual and find the equivalent hex digits associated with your choice of Label ID. For example, if you wish to select an equal sign (=) as a Label ID, the chart indicates its associated hex characters as 3D. Turn to [Keypad, starting on page 285](#) and scan the bar codes representing the hex characters determined. For the example given, the characters '3' and 'D' would be scanned. More examples of Label ID settings are provided in [Table 13](#).



NOTE

If you make a mistake before the last character, scan the CANCEL bar code to abort and not save the entry string. You can then start again at the beginning.

6. Scan the ENTER/EXIT bar code to exit Label ID entry.
7. Scan the ENTER/EXIT bar code once again to exit Programming Mode.

This completes the steps to configure a Label ID for a given symbology.

Figure 8. Label ID Position Options

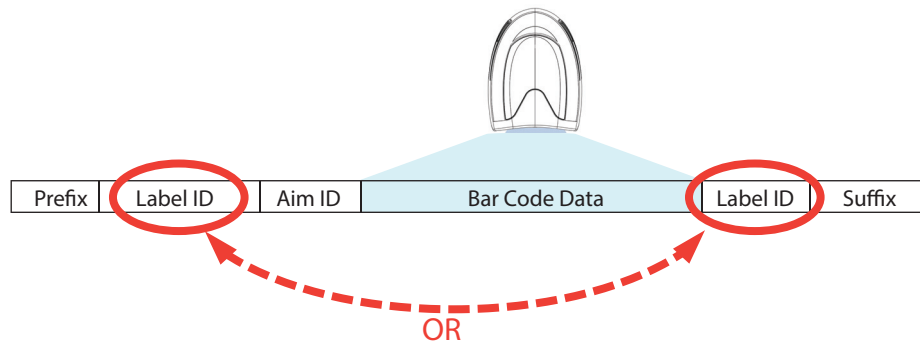

Label ID: Set Individually Per Symbology — continued

Table 13. Label ID Examples

STEP	ACTION	EXAMPLES			
1.	Scan the ENTER/EXIT bar code	(Scanner enters Programming Mode)			
2.	Determine placement of the Label ID characters BEFORE or AFTER with regard to scanned data using "Label ID Control" on page 79	Enable as Prefix	Enable as Suffix	Enable as Prefix	Enable as Suffix
3.	Scan the bar code selecting the symbology type you wish to designate label ID characters for using Label ID Symbology Selection, starting on page 80.	GS1 DataBar Omnidirectional	Code 39	Interleaved 2 of 5	Code 32
4.	Custom Label ID example (desired characters):	D B *	= C 3	+	P H
5.	Find hex equivalents from the ASCII table (inside back cover), then scan in these digits/characters using the bar codes in the section: Keypad, starting on page 285. If you make a mistake before the last character, scan the CANCEL bar code to abort and not save the entry string. You can then start again at the beginning.	44 42 2A	3D 43 33	2B	50 48
6.	Scan the ENTER/EXIT bar code	(Scanner exits Label ID entry)			
7.	Scan the ENTER/EXIT bar code once again	(Scanner exits Programming Mode)			
Result:					
		DB*[bar code data]	[bar code data]=C3	+ [bar code data]	[bar code data]PH

Character Conversion

Character conversion is an eight byte configuration item. The eight bytes are 4 character pairs represented in hexadecimal ASCII values. The first character in the pair is the character that will be converted. The second character in the pair is the character to convert to. If the character to convert in a pair is FF, then no conversion is done.

For example, if you have the character conversion configuration item set to the following: 41423132FFFFFFFF

The first pair is 4142 or AB (41 hex is an ASCII capital A, 42 hex is an ASCII capital B) and the second pair is 3132 or 12 (31 hex is an ASCII 1, 32 is an ASCII 2). The other two pairs are FFFF and FFFF.

With the label, AB12BA21, it would look as follows after the character conversion: BB22BB22.

The A characters were converted to B characters and the 1 characters were converted to 2 characters. Nothing is done with the last two character pairs, since they are all FF.

To set Character Conversion:

1. Scan the ENTER/EXIT bar code.
2. Scan the bar code for "Character Conversion" on page 86
3. Determine the desired string. Sixteen positions must be determined as in the above example. Next, turn to the [ASCII Chart on page 293](#) on the inside back cover of this manual and find the equivalent hex digits needed to fulfill the string.
4. Turn to [Appendix D, Keypad](#) and scan the bar codes representing the hex characters determined in the previous step.
5. Scan the ENTER/EXIT bar code to exit Programming Mode.



NOTE

If less than the expected string of 16 characters are selected, scan the ENTER/EXIT bar code twice to accept the selections and exit Programming Mode.

Scanning Features

Scan Mode

Selects the scan operating mode for the reader. Selections are:

Trigger Single: When the trigger is pulled, scanning is activated until one of the following occurs:

- **Stand Mode Indication** has elapsed
- a label has been read
- the trigger is released

This mode is associated with typical handheld reader operation: when the trigger is pulled, scanning starts and the product scans until the trigger is released, or a label is read, or the maximum **Stand Mode Indication** has elapsed.

Trigger Hold Multiple : When the trigger is pulled, scanning starts and the product scans until the trigger is released or **Stand Mode Indication** has elapsed. Reading a label does not disable scanning. **Double Read Timeout** prevents undesired multiple reads of the same label while in this mode.

Trigger Pulse Multiple: When the trigger is pulled, continuous scanning is activated until **Stand Mode Indication** has elapsed or the trigger has been released and pulled again. **Double Read Timeout** prevents undesired multiple reads of the same label while in this mode.

Flashing: The reader flashes¹ on and off regardless of the trigger status. Flash rate is controlled by **Flash On Time** and **Flash Off Time**. When Flash is ON the reader reads continuously. When Flash is OFF scanning is deactivated.

Always On: No trigger pull is required to read a bar code. Scanning is continually on. **Double Read Timeout** prevents undesired multiple reads of the same label while in this mode.

Stand Mode: No trigger pull is required to read a bar code. Scanning turns on automatically when an item is placed in reader's field of view. While in a stand watch state, the reader illumination LED goes from dim to maximum bright.

¹Controlled by **Flash On Time**.

Scanning Active Time

This setting specifies the amount of time that the reader stays in scan ON state once the state is entered. The range for this setting is from 1 to 255 seconds in 1-second increments.

Follow these instructions to set this feature:

1. Determine the desired setting.
2. Pad the result with leading zeroes to yield three digits. For example: 0 = 000, 5 = 005, 20 = 020, etc.
3. Scan the ENTER/EXIT PROGRAMMING MODE bar code to enter Programming Mode.
4. Scan the bar code: SELECT SCANNING ACTIVE TIME SETTING on [page 100](#).
5. Scan the appropriate three digits from the keypad in [Appendix D, Keypad](#) that represent the duration which was determined in the steps above. You will hear a two-beep indication after the last character.



NOTE

If you make a mistake before the last character, scan the CANCEL bar code to abort and not save the entry string. You can then start again at the beginning.

6. Scan the ENTER/EXIT PROGRAMMING MODE bar code to exit Programming Mode.

This completes the procedure. See the table below for examples of how to set this feature.

Table 14. Scanning Active Time Setting Examples

STEP	ACTION	EXAMPLES			
1	Desired Setting	1 Second	90 Sec. (1.5 min.)	180 Sec. (3 min.)	255 Seconds (4.25 min.)
2	Pad leading zero(es)	001	090	180	255
3	Scan ENTER/EXIT PROGRAMMING MODE				
4	Scan SELECT SCANNING ACTIVE TIME SETTING				
5	Scan Three Characters From Appendix D, Keypad	'0', '0' and '1'	'0', '9' and '0'	'1', '8' and '0'	'2', '5' and '5'
6	Scan ENTER/EXIT PROGRAMMING MODE				

Flash On Time

This feature specifies the ON time for the indicator LED while in Flash Mode. The selectable range is 100 to 9,900 milliseconds (0.1 to 9.9 seconds), in 100 millisecond increments.

Follow these instructions to set this feature.

1. Determine the desired setting in milliseconds.
2. Divide the desired setting by 100 (setting is in 100ms increments). Pad the result with leading zeroes to yield two digits. For example: 0 = 00, 5 = 05, 20 = 20, etc.
3. Scan the ENTER/EXIT PROGRAMMING MODE bar code to enter Programming Mode.
4. Scan the bar code: SELECT FLASH ON TIME SETTING on [page 98](#)
5. Scan the appropriate two digits from the keypad in [Appendix D, Keypad](#) representing the duration which was determined in the steps above. You will hear a two-beep indication after the last character.



NOTE

If you make a mistake before the last character, scan the CANCEL bar code to abort and not save the entry string. You can then start again at the beginning.

6. Scan the ENTER/EXIT PROGRAMMING MODE bar code to exit Programming Mode.

This completes the procedure. See the table below for examples of how to set this feature.

Table 15. Flash On Time Setting Examples

STEP	ACTION	EXAMPLES			
1	Desired Setting	500ms	1,000ms (1 sec.)	5200ms (5.2 sec.)	9,900ms (9.9 sec.)
2	Divide by 100 (and pad with leading zeroes to yield two digits)	05	10	52	99
3	Scan ENTER/EXIT PROGRAMMING MODE				
4	Scan SELECT FLASH ON TIME SETTING				
5	Scan Two Characters From Appendix D, Keypad	'0' and '5'	'1' and '0'	'5' and '2'	'9' and '9'
6	Scan ENTER/EXIT PROGRAMMING MODE				

Flash Off Time

This feature specifies the OFF time for the indicator LED while in Flash Mode. The selectable range is 100 to 9,900 milliseconds (0.1 to 9.9 seconds), in 100 millisecond increments.

Follow these instructions to set this feature.

1. Determine the desired setting in milliseconds.
2. Divide the desired setting by 100 (setting is in 100ms increments). Pad the result with leading zeroes to yield two digits. For example: 0 = 00, 5 = 05, 20 = 20, etc.
3. Scan the ENTER/EXIT PROGRAMMING MODE bar code to enter Programming Mode.
4. Scan the bar code: SELECT FLASH OFF TIME SETTING on [page 99](#).
5. Scan the appropriate two digits from the keypad in [Appendix D, Keypad](#), that represent the duration which was determined in the steps above. You will hear a two-beep indication after the last character.



NOTE

If you make a mistake before the last character, scan the CANCEL bar code to abort and not save the entry string. You can then start again at the beginning.

6. Scan the ENTER/EXIT PROGRAMMING MODE bar code to exit Programming Mode.

This completes the procedure. See the table below for examples of how to set this feature.

Table 16. Flash Off Time Setting Examples

STEP	ACTION	EXAMPLES			
1	Desired Setting	500ms	1,000ms (1 sec.)	5200ms (5.2 sec.)	9,900ms (9.9 sec.)
2	Divide by 100 (and pad with leading zeroes to yield two digits)	05	10	52	99
3	Scan ENTER/EXIT PROGRAMMING MODE				
4	Scan SELECT FLASH OFF TIME SETTING				
5	Scan Two Characters From Appendix D, Keypad	'0' and '5'	'1' and '0'	'5' and '2'	'9' and '9'
6	Scan ENTER/EXIT PROGRAMMING MODE				

Symbologies

Set Length

Length Control allows you to select either variable length decoding or fixed length decoding for the specified symbology.

Variable Length: For variable length decoding, a minimum and maximum length may be set.

Fixed Length: For fixed length decoding, two different lengths may be set.

Set Length 1

This feature specifies one of the bar code lengths for a given symbology. Length 1 is the minimum label length if in Variable Length Mode, or the first fixed length if in Fixed Length Mode.

Reference the [1D Symbologies on page 113](#) section to view the selectable range (number of characters) for the symbology being set.

Follow these instructions to set this feature:

1. Determine the desired character length. Pad the number with leading zeroes to yield two digits. For example: 0 = 00, 5 = 05, 20 = 20, etc.
2. Scan the ENTER/EXIT PROGRAMMING MODE bar code to enter Programming Mode.
3. Scan the “Select Length 1 Setting” for the symbology being set.
4. Scan the appropriate two digits from the keypad in [Appendix D, Keypad](#), that represent the length setting which was determined in the steps above. You will hear a two-beep indication after the last character.



If you make a mistake before the last character, scan the **CANCEL** bar code to abort and not save the entry string. You can then start again at the beginning.

NOTE

5. Scan the ENTER/EXIT PROGRAMMING MODE bar code to exit Programming Mode.

This completes the procedure. See the table below for examples of how to set this feature.

Table 17. Length 1 Setting Examples

STEP	ACTION	EXAMPLES			
1	Desired Setting	01 Character	07 Characters	52 Characters	74 Characters
2	Scan ENTER/EXIT PROGRAMMING MODE				
3	Scan SELECT LENGTH 1SETTING for the desired symbology				
4	Scan Two Characters From Appendix D, Keypad	'0' and '1'	'0' and '7'	'5' and '2'	'7' AND '4'
5	Scan ENTER/EXIT PROGRAMMING MODE				

Set Length 2

This feature specifies one of the bar code lengths for a given symbology. Length 2 is the maximum label length if in Variable Length Mode, or the second fixed length if in Fixed Length Mode.

Reference the [1D Symbologies on page 113](#) section to view the selectable range (number of characters) for the symbology being set. A setting of 00 specifies to ignore this length (only one fixed length).

Follow these instructions to set this feature:

1. Determine the desired character length. Pad the number with leading zeroes to yield two digits. For example: 0 = 00, 5 = 05, 20 = 20, etc.
2. Scan the ENTER/EXIT PROGRAMMING MODE bar code to enter Programming Mode.
3. Scan the “Select Length 2 Setting” for the symbology being set.
4. Scan the appropriate two digits from the keypad in [Appendix D, Keypad](#), that represent the length setting which was determined in the steps above. You will hear a two-beep indication after the last character.



NOTE

If you make a mistake before the last character, scan the CANCEL bar code to abort and not save the entry string. You can then start again at the beginning.

5. Scan the ENTER/EXIT PROGRAMMING MODE bar code to exit Programming Mode.

This completes the procedure. See the table below for examples of how to set this feature.

Table 18. Length 2 Setting Examples

STEP	ACTION	EXAMPLES			
1	Desired Setting	00 (ignore second length)	07 Characters	52 Characters	74 Characters
2	Scan ENTER/EXIT PROGRAMMING MODE				
3	Scan SELECT LENGTH 2 SETTING				
4	Scan Two Characters From Appendix D, Keypad	'0' and '0'	'0' and '7'	'5' and '2'	'7' and '4'
5	Scan ENTER/EXIT PROGRAMMING MODE				



Appendix A

Technical Specifications

The table below contains Physical and Performance Characteristics, User Environment and Regulatory information. Table 21 provides Standard Cable Pinouts.

Table 19. Technical Specifications

Electrical Features	
Power Supply	GD4520: 5 VDC GD4590: 4.5 - 14.0 VDC
Consumption:	Operating (Typical): <300 mA @ 5V <200 mA @ 12V Standby/Idle (Typical): <90 mA @ 5V <50 mA @ 12V
Max. Scan Rate	50 frames/sec
Reading Indicators	Top and rear illumination, Good Read Spot, Beep
Optical Features	
Optical Format	1/4"
Active Imager Size	3896 um (H) x 2453 um (V)
Active Pixels	1280 H x 800 V
Illumination System	LED source Warm White Emission (wavelength = 350 - 770 nm) Hyper Red Emission (wavelength = 660 nm, DGM model only) IEC 62471 Exempt Risk Group
Aiming System	RED laser source IEC 60825-1 Class 2 Radiation 1 mW Avg., Emitted wavelength 650 nm, 10ms pulse
Ambient Light	Up to 100,000 lux
Tilt Tolerance	0° - 360°
Pitch Tolerance	± 65°

Optical Features (continued)	
Skew Tolerance	± 65
Field of View	36° H x 23° V
PCS (Datalogic Test Chart)	minimum 15%

DOF - Depth of Field (Typical) ^a		
Symbology	SR	HD
Code 39	5 mil: 7.0 - 38.0 cm (2.7" - 14.9") 10 mil: 2.2 - 58.0 cm (0.8" - 22.8") 20 mil: FOV lim. - 110 cm (up to 43.3")	3 mil: 5.0 - 15.0 cm (2.0" - 5.9") 5 mil: 0.5 - 25.0 cm (0.2" - 9.8") 10 mil: 0.5 - 45.0 cm (0.2" - 17.7")
EAN13	7.5 mil: 9.0 - 30.0 cm (3.5" - 11.8") 13 mil: 1.0 - 71.0 cm (0.4" - 27.9")	7.5 mil: 2.0 - 23.5 cm (0.8" - 9.2") 13 mil: 1.0 - 40.0 cm (0.4" - 15.7")
PDF417	6.6 mil: 6.5 - 24.0 cm (2.6" - 9.4") 10 mil: 2.5 - 41.0 cm (1.0" - 16.1") 15 mil: 2.3 - 65.0 cm (0.9" - 25.6")	4 mil: 3.0 - 12.0 cm (1.2" - 4.7") 6.6 mil: 0.5 - 23.5 cm (0.2" - 9.2") 10 mil: 0.5 - 31.0 cm (0.2" - 12.2")
Datamatrix	10 mil: 5.5- 27.0 cm (2.2" - 10.6") 15 mil: 2.8 - 41.0 cm (1.1" - 16.1")	5 mil: 5.5 - 9.0 cm (2.2" - 3.5") 10 mil: 0.2 - 27.0 cm (0.1" - 10.6")
Max Resolution	1D Min = 4 mils PDF417 Min = 5 mils Datamatrix Min = 7.5 mils	1D Min = 3 mils PDF417 Min = 3 mils Datamatrix Min = 4 mils

^a. 13 mils DOF based on EAN. All other 1D codes are Code 39. All labels grade A, typical environmental light, 20°C, label inclination 10°

Environmental Features	
Operating Temperature	0 °C to + 50 °C (+32° F to +122 °F)
Storage Temperature	-40 °C to + 70 °C (-40 ° F to +158 °F)
Humidity	95% non condensing
Drop Resistance	IEC 68-2-32 Tested 1.8 m (6 ft)
ESD Protection	16 KV
Protection Class	IP52
Weight (without cable)	GD4500 approx. 161 g (5.7 oz.) GD4500 with integrated stand approx. 374 g (13.2 oz.)
Cable Length	Refer to www.datalogic.com

Decode Capability
<p>1D Bar Codes</p> <p>UPC/EAN/JAN (A, E, 13, 8); UPC/EAN/JAN (including P2 /P5); UPC/EAN/JAN (including; ISBN / Bookland & ISSN); UPC/EAN Coupons; Code 39 (including full ASCII); Code 39 Trioptic; Code39 CIP (French Pharmaceutical); LOGMARS (Code 39 w/ standard check digit enabled); Danish PPT; Code 32 (Italian Pharmacode 39); Code 128; Code 128 ISBT; Interleaved 2 of 5; Standard 2 of 5; Interleaved 2 of 5 CIP (HR); Industrial 2 of 5; Discrete 2 of 5; Matrix 2 of 5; IATA 2of5 Air cargo code; Code 11; Codabar; Codabar (NW7); ABC Codabar; EAN 128; Code 93 ; MSI; PZN; Plessey; Anker Plessey; GS1 DataBar Omnidirectional; GS1 DataBar Limited; GS1 DataBar Expanded; GS1 DataBar Truncated; DATABAR Expanded Coupon.</p>
<p>2D / Stacked Codes</p> <p>The Gryphon I GD4500 scanner is capable of decoding the following symbologies using multiple frames (i.e. Multi-Frame Decoding):</p> <p>Datamatrix; Inverse Datamatrix; Datamatrix is configurable for the following parameters; Normal or Inverted; Square or Rectangular Style; Data length (1 - 3600 characters); Maxicode; QR Codes (QR, Micro QR and Multiple QR Codes); Aztec; Postal Codes - (Australian Post; Japanese Post; KIX Post; Planet Code; Postnet; Royal Mail Code (RM45CC); Intelligent Mail Barcode (IMB); Sweden Post; Portugal Post); LaPoste A/R 39; PDF-417; MacroPDF; Micro PDF417; GS1 Composites (1 - 12); French CIP13^a; GS1 DataBar Stacked; GS1 DataBar Stacked Omnidirectional; GS1 DataBar Expanded Stacked; GSI Databar Composites; Chinese Sensible Code; Inverted 2D codes^b.</p> <p>^aIt is acceptable to handle this with ULE</p> <p>^bThe SW can apply the Normal/Reverse Decoding Control to the following symbologies: Datamatrix, QR, Micro QR, Aztec and Chinese Sensible Code.</p>

LED and Beeper Indications

The imager’s beeper sounds and its illumination flashes or changes color to indicate various functions or errors on the reader. A “Green Spot” also lights to indicate a good read. The tables below list these indications.

Table 20. LED and Speaker Indications

Indication	LED	Beeper	Indication
Power-up	Upper LED flashes/blinks on power-up, however, this may be too rapid to view. With a USB interface, the LED blinks until enumeration with the host is completed.	Imager beeps four times at highest frequency and volume upon power-up.	Power-up
Good Read	Upper green LED comes on for programmed time (default). LED behavior for this indication is configurable using Aladdin utility.	One beep at current frequency, volume, mono/bi-tonal setting upon a successful label scan.	Good Read
ROM Failure	200ms on / 200ms off	Imager sounds one error beep at highest volume for 200 mS.	ROM Failure
Limited Scanning Label Read	N/A	Imager 'chirps' six times at the highest frequency and current volume.	Limited Scanning Label Read
Imager Disabled	The LED blinks continuously 100mS on / 900 mS off	N/A	Imager Disabled

Programming Mode

The following indications ONLY occur when the scanner is in Programming Mode.

INDICATION	DESCRIPTION	LED	SPEAKER
Label Programming Mode Entry	A valid programming label has been scanned.	LED blinks continuously	Scanner sounds four low frequency beeps.
Label Programming Mode Rejection of Label	A label has been rejected.	N/A	Scanner sounds three times at lowest frequency & current volume.
Label Programming Mode Acceptance of Partial Label	In cases where multiple labels must be scanned to program one feature, this indication acknowledges each portion as it is successfully scanned.	N/A	Scanner sounds one short beep at highest frequency & current volume.
Label Programming Mode Acceptance of Programming	Configuration option(s) have been successfully programmed via labels and the scanner has exited Programming Mode.	N/A	Scanner sounds one high frequency beep and 4 low frequency beeps followed by reset beeps.
Label Programming Mode Cancel Item Entry	Cancel label has been scanned.	N/A	Scanner sounds two times at low frequency and current volume.

Troubleshooting

Problem	Possible Cause	Possible Solutions
Nothing happens when the scan button is pulled.	No power to the imager.	Check system power. Ensure power supply is connected.
	Interface or power cables are loose.	Ensure all cable connections are secure.
LED comes on, but bar code does not decode.	Imager not programmed for correct bar code type.	Ensure imager is programmed to read the type of bar code scanned. Refer to the PRG for more information.
	Bar code label is unreadable.	Check the label to ensure it is not defaced. Try scanning another bar code type.
	Distance between imager and bar code is incorrect.	Move imager closer to or further from the bar code.
Bar code is decoded but not transmitted to the host.	Imager not programmed for the correct host type.	Scan the appropriate host type bar code. Refer to the PRG for more information.

Standard Cable Pinouts

Figure 9 and Table 21 provide standard pinout information for the scanner's cable.

Figure 9. Standard Cable Pinouts

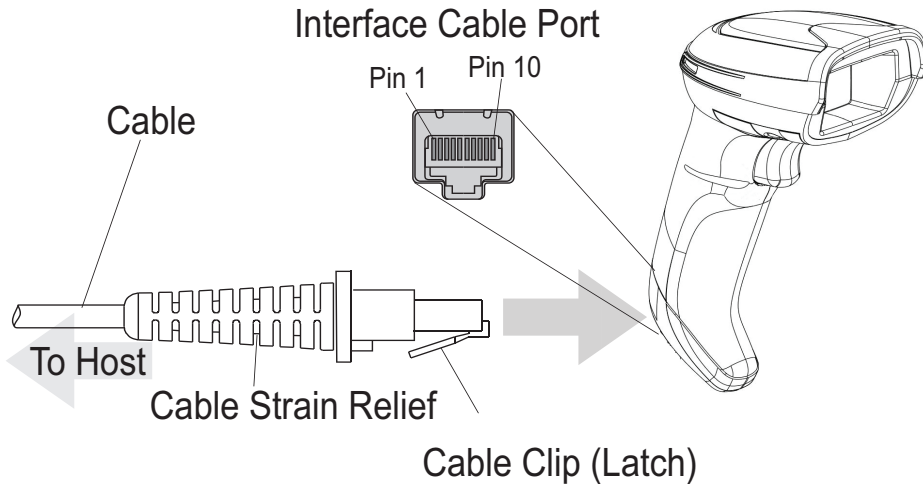

The signal descriptions in Table 21 apply to the connector on the scanner and are for reference only.

Table 21. Standard Cable Pinouts — Scanner Side

Pin	RS-232	USB	Keyboard Wedge
1	RTS (out)		
2		D+	CLKIN (KBD side)
3		D-	DATAIN (KBD side)
4	GND	GND	GND
5	RX		
6	TX		
7	VCC	VCC	VCC
8			CLKOUT (PC side)
9			DATAOUT (PC side)
10	CTS (in)		



Appendix B

Standard Defaults

The most common configuration settings are listed in the “Default” column of the table below. Page references are also provided for feature descriptions and programming bar codes for each parameter. A column has also been provided for recording of your preferred default settings for these same configurable features.

Table 22. Standard Defaults

Parameter	Default	Your Setting	Page Number
GLOBAL INTERFACE FEATURES			
Host Commands — Obey/Ignore	Obey		21
USB Suspend Mode	Enable		21
RS-232 ONLY			
Baud Rate	9600		23
Data Bits	8 Data Bits		24
Stop Bits	1 Stop Bit		25
Parity	None		25
Handshaking Control	RTS		26
RS-232/USB-COM			
Intercharacter Delay	No Delay		28
Beep On ASCII BEL	Disable		29
Beep On Not on File	Enable		29
ACK NAK Options	Disable		30
ACK Character	'ACK'		31
NAK Character	'NAK'		31
ACK NAK Timeout Value	200 ms		32
ACK NAK Retry Count	3 Retries		33
ACK NAK Error Handling	Ignore Errors Detected		34
Indicate Transmission Failure	Enable		35
Disable Character	'D'		35

Parameter	Default	Your Setting	Page Number
Enable Character	'E'		36
KEYBOARD WEDGE			
Country Mode	U.S. Keyboard		38
Keyboard Send Control Characters	00		63
Wedge Quiet Interval	100 ms		64
Intercode Delay	No Delay		66
Caps Lock State	Caps Lock OFF		61
Numlock	NumLock Key Unchanged		61
USB Keyboard Speed	1 ms		67
Keyboard Numeric Keypad	Standard Keys		62
USB-OEM			
USB-OEM Device Usage	Handheld		70
USB-OEM Interface Options	Ignore Scanner Configuration Host Commands		70
DATA FORMAT			
Global Prefix/Suffix	No Global Prefix Global Suffix = 0x0D (CR)		76
Global AIM ID	Disable		77
GS1-128 AIM ID	Enable		77
Label ID: Pre-loaded Sets	EU Set		78
Label ID: Pre-loaded Sets	Disable		78
Case Conversion	Disable		85
Character Conversion	No Char Conversion		86
READING PARAMETERS			
Double Read Timeout	0.6 Second		88
Power On Alert	Power-up Beep		91
Good Read: When to Indicate	After Decode		92
Good Read Beep Type	Mono		93
Good Read Beep Frequency	High		93
Good Read Beep Length	80 ms		95

Parameter	Default	Your Setting	Page Number
Good Read Speaker Volume	High		94
Enable/Disable Good Read Indicator	300 ms		96
SCANNING FEATURES			
Scan Mode	Trigger Single		97
Stand Mode Sensitivity	Medium		102
Stand Mode Indication	5 Seconds		100
Flash On Time	OFF		98
Flash On Time	10 = Flash is ON for 1 Second		98
Flash Off Time	06 = Flash is OFF for 600ms		99
CODE SELECTION - 1D SYMBOLOGIES			
Code EAN/UPC			
Coupon Control	Enable only UPCA coupon decoding		114
UPC-A			
UPC-A Enable/Disable	Enable		115
UPC-A Check Character Transmission	Send		115
Expand UPC-A to EAN-13	Don't Expand		116
UPC-A Number System Character Transmission	Transmit		116
UPC-E			
UPC-E Enable/Disable	Enable		118
UPC-E Check Character Transmission	Send		118
Expand UPC-E to EAN-13	Don't Expand		119
Expand UPC-E to UPC-A	Don't Expand		119
UPC-E Number System Character Transmission	Transmit		120
GTIN			
EAN 13	Disable		121

Parameter	Default	Your Setting	Page Number
EAN 13 (Jan 13)			
EAN 13 Enable/Disable	Enable		121
EAN 13 Check Character Transmission	Send		121
EAN-13 Flag 1 Character	Transmit		122
EAN-13 ISBN Conversion	Disable		122
ISSN	Disable		123
EAN 8			
EAN 8 Enable/Disable	Enable		124
EAN 8 Check Character Transmission	Send		124
Expand EAN 8 to EAN 13	Disable		125
UPC/EAN Global Settings			
UPC/EAN Price Weight Check	Disable		126
Add-Ons			
Optional Add-ons	Disable P2, P5 and P8		127
Optional Add-On Timer	70 ms		128
Code 39			
Code 39 Enable/Disable	Enable		135
Code 39 Check Character Calculation	Disable		135
Code 39 Check Character Transmission	Send		136
Code 39 Start/Stop Character Transmission	Don't Transmit		137
Code 39 Full ASCII	Disable		137
Code 39 Quiet Zones	Small Quiet Zones on two sides		138
Code 39 Length Control	Variable		139
Code 39 Set Length 1	2		140
Code 39 Set Length 2	50		141
Code 32 (Italian Pharmaceutical Code)			
Code 32 Enable/Disable	Disable		142
Code 32 Check Character Transmission	Don't Send		142

Parameter	Default	Your Setting	Page Number
Code 32 Start/Stop Character Transmission	Don't Transmit		143
Code 39 CIP (French Pharmaceutical Code)			
Code 39 CIP Enable/Disable	Disable		143
Special Codes			
Code 128			
Code 128 Enable/Disable	Enable		144
Expand Code 128 to Code 39	Don't Expand		144
Code 128 Check Character Transmission	Don't Send		145
Code 128 Function Character Transmission	Don't Send		145
Code 128 Quiet Zones	Small Quiet Zones on two sides		146
Code 128 Length Control	Variable		147
Code 128 Set Length 1	1		147
Code 128 Set Length 2	80		148
GS1-128			
GS1-128 Enable	Transmit in Code 128 Data Format		149
ISBT 128			
ISBT 128 Concatenation	Disable		180
ISBT 128 Force Concatenation	Disable		182
ISBT 128 Concatenation Mode	Static		180
ISBT 128 Dynamic Concatenation Timeout	200 msec		181
Interleaved 2 of 5			
I 2 of 5 Enable/Disable	Disable		150
I 2 of 5 Check Character Calculation	Disable		151
I 2 of 5 Check Character Transmission	Send		152
I 2 of 5 Length Control	Variable		152
I 2 of 5 Set Length 1	6		153
I 2 of 5 Set Length 2	50		154

Standard Defaults

Parameter	Default	Your Setting	Page Number
Interleaved 2 of 5 CIP HR			
Interleaved 2 of 5 CIP HR Enable/Disable	Disable		155
Follett 2 of 5			
Follett 2 of 5 Enable/Disable	Disable		192
Standard 2 of 5			
Standard 2 of 5 Enable/Disable	Disable		171
Standard 2 of 5 Check Character Calculation	Disable		171
Standard 2 of 5 Check Character Transmission	Send		172
Standard 2 of 5 Length Control	Variable		172
Standard 2 of 5 Length Control	8		172
Standard 2 of 5 Set Length 2	50		174
Industrial 2 of 5			
Industrial 2 of 5 Enable/Disable	Disable		175
Industrial 2 of 5 Check Character Calculation	Disable		175
Industrial 2 of 5 Check Character Transmission	Enable		176
Industrial 2 of 5 Length Control	Variable		176
Industrial 2 of 5 Set Length 1	1		177
Industrial 2 of 5 Set Length 2	50		178
Code IATA			
IATA Enable/Disable	Disable		179
IATA Check Character Transmission	Enable		179

Parameter	Default	Your Setting	Page Number
Codabar			
Codabar Enable/Disable	Disable		159
Codabar Check Character Calculation	Don't Calculate		159
Codabar Check Character Transmission	Send		160
Codabar Start/Stop Character Transmission	Transmit		160
Codabar Start/Stop Character Set	abcd/abcd		161
Codabar Start/Stop Character Match	Don't Require Match		161
Codabar Quiet Zones	Small Quiet Zones on two sides		162
Codabar Length Control	Variable		163
Codabar Set Length 1	3		163
Codabar Set Length 2	50		164
ABC Codabar			
ABC Codabar Enable/Disable	Disable		165
ABC Codabar Concatenation Mode	Static		165
ABC Codabar Dynamic Concatenation Timeout	200 msec		166
ABC Codabar Force Concatenation	Disable		166
Code 11			
Code 11 Enable/Disable	Disable		167
Code 11 Check Character Calculation	Check C and K		167
Code 11 Check Character Transmission	Send		168
Code 11 Length Control	Variable		168
Code 11 Set Length 1	4		169
Code 11 Set Length 2	50		170
GS1 DataBar Omnidirectional			
GS1 DataBar Omnidirectional Enable/Disable	Disable		129
GS1 DataBar Omnidirectional GS1-128 Emulation	Disable		130

Parameter	Default	Your Setting	Page Number
GS1 DataBar™ Expanded			
GS1 DataBar Expanded Enable/Disable	Disable		131
GS1 DataBar Expanded GS1-128 Emulation	Disable		131
	2D component not required		131
GS1 DataBar Expanded Length Control	Variable		132
GS1 DataBar Expanded Set Length 1	1		132
GS1 DataBar Expanded Set Length 2	74		133
GS1 DataBar™ Limited			
GS1 DataBar Limited Enable/Disable	Disable		134
GS1 DataBar Limited GS1-128 Emulation	Disable		134
Code 93			
Code 93 Enable/Disable	Disable		187
Code 93 Check Character Calculation	Enable Check C and K		187
Code 93 Check Character Transmission	Disable		188
Code 93 Length Control	Variable		188
Code 93 Set Length 1	1		189
Code 93 Set Length 2	50		190
Code 93 Quiet Zones	Small Quiet Zones on two sides		191
MSI			
MSI Enable/Disable	Disable		183
MSI Check Character Calculation	Enable Mod10		183
MSI Check Character Transmission	Enable		184
MSI Length Control	Variable		184
MSI Set Length 1	1		185
MSI Set Length 2	50		186
MOTION FEATURES			

Parameter	Default	Your Setting	Page Number
Motion Aiming Control	Enable		231
Motion Sensitivity	Medium		232
Motionless Timeout	2 seconds		233

Default Exceptions

Table 23. Default Exceptions by Interface Type

Parameter	Default Exception
Interfaces: USB-OEM	
Global Suffix	No Global Suffix
Double Read Timeout	500 msec
Interfaces: All Keyboard Wedge, USB Keyboard	
No unique settings	
Interface: RS232-WN	
Expand UPC-A to EAN-13	Enable
UPC-E Check Character Transmission	Disable
Parity	Odd Parity
Handshaking Control	RTS/CTS
Transmission Label ID Code	Prefix
GS1-128 AIM ID	Disable
UPCE Label ID Character(s)	C
EAN 8 Label ID Character(s)	B
EAN 13 Label ID Character(s)	A
Code ISBN Label ID Character(s)	A
Code 39 Label ID Character(s)	M
Interleaved 2of5 Label ID Character(s)	I
Code Standard 2/5 Label ID Character(s)	H
Codabar Label ID Character(s)	N
Code 128 Label ID Character(s)	K

Standard Defaults

Parameter	Default Exception
GS1-128 Label ID Character(s)	P
Datalogic 2 of 5 Label ID Character(s)	H
ISBT 128 Label ID Character(s)	K
UPCE P2 Label ID Character(s)	C
UPCE/P5 Label ID Character(s)	C
UPCE/GS1-128 Label ID Character(s)	C
EAN8/P2 Label ID Character(s)	B
EAN8/P5 Label ID Character(s)	B
EAN8/GS1-128 Label ID Character(s)	B
EAN13/P2 Label ID Character(s)	A
EAN13/P5 Label ID Character(s)	A
EAN13/GS1-128 Label ID Character(s)	A
GS1 DataBar 14 (Omnidirectional) Label ID Character(s)	E
GS1 DataBar Expanded Label ID Character(s)	E
GS1 DataBar Limited Label ID Character(s)	E
Character Conversion	CR to `
Interface: RS232-OPOS	
Baud Rate	115200 Baud
Transmission Label ID Code	Prefix
GS1-128 AIM ID	Disable
UPCA Label ID Character(s)	C
UPCE Label ID Character(s)	D
EAN 8 Label ID Character(s)	A
EAN 13 Label ID Character(s)	B
Code ISBN Label ID Character(s)	@
Code 39 Label ID Character(s)	V
Code 32 Label ID Character(s)	X
Interleaved 2of5 Label ID Character(s)	N
Code Standard 2/5 Label ID Character(s)	P

Parameter	Default Exception
Codabar Label ID Character(s)	R
Code 11 Label ID Character(s)	b
Code 128 Label ID Character(s)	T
GS1-128 Label ID Character(s)	k
UPCA/P2 Label ID Character(s)	F
UPCA/P5 Label ID Character(s)	G
UPCA/GS1-128 Label ID Character(s)	Q
UPCE P2 Label ID Character(s)	H
UPCE/P5 Label ID Character(s)	I
EAN8/P2 Label ID Character(s)	J
EAN8/P5 Label ID Character(s)	K
EAN8/GS1-128 Label ID Character(s)	*
EAN13/P2 Label ID Character(s)	L
EAN13/P5 Label ID Character(s)	M
EAN13/GS1-128 Label ID Character(s)	#
GS1 DataBar 14 (Omnidirectional) Label ID Character(s)	u
GS1 DataBar Expanded Label ID Character(s)	t
GS1 DataBar Limited Label ID Character(s)	v

NOTES



Appendix C

Sample Bar Codes

The sample bar codes in this appendix are typical representations for their symbology types.

1D Bar Codes

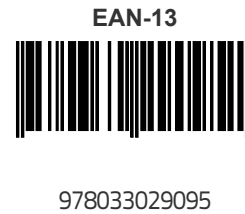

Sample Bar Codes (continued)

Code 32

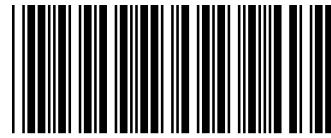

B9P91Q

Codabar

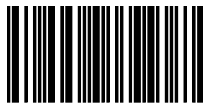

13579

Code 93



ABCDEF

Code 11



123456789

GS1 DataBar™ (RSS)



GS1 DataBar™ variants must be enabled to read the bar codes below (see "GS1 DataBar™ Omnidirectional" on page 129).

GS1 DataBar™ Expanded Stacked



10293847560192837465019283746029478450366523

GS1 DataBar™ Expanded



1234890hjo9900mnb

GS1 DataBar™ Limited



08672345650916

GS1 DataBar™-14

GS1 DataBar™ Omnidirectional Truncated



55432198673467

GS1 DataBar™ Omnidirectional Stacked



90876523412674

GS1 DataBar™ Omnidirectional Stacked



78123465709811

2D Bar Codes

Aztec



Datamatrix



China Sensible Code



MaxiCode

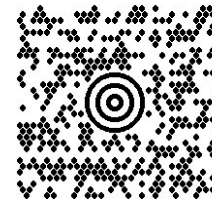

Test Message

PDF 417



ABCabc

Micro PDF 417



BV17453

QR Code

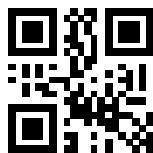

35900G9

Micro QR Code



123456

UCC Composite

(17) 050923 (10) ABC123



(01) 0 4012345 67890 1 1



Appendix D

Keypad

Use the bar codes in this appendix to enter numbers as you would select digits/characters from a keypad.



0



1

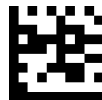

2



3



4



5



6



7



8



9



A



B



C



D



E



F



Appendix E

Scancode Tables

Control Character Emulation

Control character emulation selects from different scancode tables as listed in this appendix. Each of the control character sets below are detailed by interface type in the tables. These apply to Wedge and USB Keyboard platforms.

Control Character 00: Characters from 00 to 0x1F are sent as control character Ctrl+Keys, special keys are located from 0x80 to 0xA1.

Control Character 01: Characters from 00 to 0x1F are sent as control character Ctrl+Capital Key, special keys are located from 0x80 to 0xA1.

Control Character 02: Special keys are located from 00 to 0x1F and characters from 0x80 to 0xFE are intended as an extended ASCII table (Microsoft Windows Codepage 1252 — see [page 292](#)).

Single Press and Release Keys

In the following tables, Ar↓ means Alt right pressed and Ar↑ means Alt right released and so on. Definitions for other keys are Al (Alt left), Cr (Control Right) Cl (Control Left) Sh (shift). This method can be used for combining Alt, Control or Shift with other keys.

Example: Consider a Control character set to 00. If AltRight+A is required before sending a label to the host, it could be done by setting three Prefix keys in this way: 0x99 0x41 0x9A.

Interface Type PC AT PS/2 or USB-Keybaord

Table 24. Scancode Set When Control Character is 00 or 01

	x0	x1	x2	x3	x4	x5	X6	x7	x8	x9	xA	xB	xC	xD	xE	xF
0x	NULL C+@	SOH C(S)+A	STX C(S)+B	ETX C(S)+C	EOT C(S)+D	ENQ C(S)+E	ACK C(S)+F	BEL C(S)+G	BS	HT TAB	LF C(S)+J	VT C(S)+K	FF C(S)+L	CR Enter	SO C(S)+N	SI C(S)+O
1x	DLE C(S)+P	DC1 C(S)+Q	DC2 C(S)+R	DC3 C(S)+S	DC4 C(S)+T	NAK C(S)+U	SYN C(S)+V	ETB C(S)+W	CAN C(S)+X	EM C(S)+Y	SUB C(S)+Z	ESC Esc	FS C+\ C+]	GS C+]	RS C+^	US C(S)+_
2x	SP	!	"	#	\$	%	&	'	()	*	+	,	-	.	/
3x	0	1	2	3	4	5	6	7	8	9	:	;	<	=	>	?
4x	@	A	B	C	D	E	F	G	H	I	J	K	L	M	N	O
5x	P	Q	R	S	T	U	V	W	X	Y	Z	[\]	^	_
6x	`	a	b	c	d	e	f	g	h	i	j	k	l	m	n	o
7x	p	q	r	s	t	u	v	w	x	y	z	{		}	~	Del
8x	€	Sh↓	Sh↑	Ins	Ent (keyp)	F1	F2	F3	F4	F5	F6	F7	F8	F9	F10	F11
9x	F12	Home	End	Pg Up	Pg Dwn	↑	↓	←	→	Ar↓	Ar↑	Al↓	Al↑	Cl↓	Cl↑	Cr↓
Ax	Cr↑		‘	f	„	…	†	‡	^	‰	Š	◀	Š	◀	Œ	
Bx	°	±	²	³	´	µ	¶	·	,	‘	°	»	¼	½	¾	¿
Cx	À	Á	Â	Ã	Ä	Å	Æ	Ç	È	É	Ê	Ë	Ì	Í	Î	Ï
Dx	Ð		Ò	Ó	Ô	Õ	Ö	×	Ø	Ù	Ú	Û	Ü	Ý	Þ	ß
Ex	à	á	â	ã	ä	å	æ	ç	è	é	ê	ë	ì	í	î	ï
Fx	ð	ñ	ò	ó	ô	õ	ö	÷	ø	ù	ú	û	ü	ý	þ	ÿ

Extended characters (sky blue) are sent through dedicated keys (when available in the selected country mode) or by using an Alt Mode sequence.

Interface Type PC AT PS/2 or USB-Keyboard (continued)

Table 25. Scancode Set When Control Character is 02

	x0	x1	x2	x3	x4	x5	X6	x7	x8	x9	xA	xB	xC	xD	xE	xF
0x	Ar↓	Ar↑	Al↓	Al↑	Cl↓	Cl↑	Cr↓	Cr↑	BS	Tab	→	S+ Tab	Enter Keyprd	Enter	Ins	Pg Up
1x	Pg Dwn	Home	←	↓	↑	F6	F1	F2	F3	F4	F5	ESC	F7	F8	F9	F10
2x	Space	!	“	#	\$	%	&	‘	()	*	+	,	-	.	/
3x	0	1	2	3	4	5	6	7	8	9	:	;	<	=	>	?
4x	@	A	B	C	D	E	F	G	H	I	J	K	L	M	N	O
5x	P	Q	R	S	T	U	V	W	X	Y	Z	[\]	^	_
6x	`	a	b	c	d	e	f	g	h	i	j	k	l	m	n	o
7x	p	q	r	s	t	u	v	w	x	y	z	{		}	~	Del
8x	€		‘	f	„	…	†	‡	^	%	Š	<	Š	<	Œ	
9x		‘	’	“	”	•	–	—	~	™	š	>	œ		ž	ÿ
Ax	NBSP	ı	¢	£	¤	¥	¦	§	¨	©	ª	«	¬	-	®	¯
Bx	°	±	²	³	´	µ	¶	·	,	ı	°	»	¼	½	¾	¿
Cx	À	Á	Â	Ã	Ä	Å	Æ	Ç	È	É	Ê	Ë	Ì	Í	Î	Ï
Dx	Ð		Ò	Ó	Ô	Õ	Ö	×	Ø	Ù	Ú	Û	Ü	Ý	Þ	ß
Ex	à	á	â	ã	ä	å	æ	ç	è	é	ê	ë	ì	í	î	ï
Fx	ð	ñ	ò	ó	ô	õ	ö	÷	ø	ù	ú	û	ü	ý	þ	ÿ

Interface Type PC AT PS/2 Alt Mode or USB-Keyboard Alt Mode

Table 26. Scancode Set When Control Character is 00 or 01

	x0	x1	x2	x3	x4	x5	X6	x7	x8	x9	xA	xB	xC	xD	xE	Xf
0x	Alt+000	Alt+001	Alt+002	Alt+003	Alt+004	Alt+005	Alt+006	Alt+007	BS	HT TAB	Alt+010	Alt+011	Alt+012	CR Enter	Alt+014	Alt+015
1x	Alt+016	Alt+017	Alt+018	Alt+019	Alt+020	Alt+021	Alt+022	Alt+023	Alt+024	Alt+025	Alt+026	ESC Esc	Alt+028	Alt+029	Alt+030	Alt+031
2x	A+032	A+033	A+034	A+035	A+036	A+037	A+038	A+039	A+040	A+041	A+042	A+043	A+044	A+045	A+046	A+047
3x	A+048	A+049	A+050	A+051	A+052	A+053	A+054	A+055	A+056	A+057	A+058	A+059	A+060	A+061	A+062	A+063
4x	A+064	A+065	A+066	A+067	A+068	A+069	A+070	A+071	A+072	A+073	A+074	A+075	A+076	A+077	A+078	A+079
5x	A+080	A+081	A+082	A+083	A+084	A+085	A+086	A+087	A+088	A+089	A+090	A+091	A+092	A+093	A+094	A+095
6x	A+096	A+097	A+098	A+099	A+100	A+101	A+102	A+103	A+104	A+105	A+106	A+107	A+108	A+109	A+110	A+111
7x	A+112	A+113	A+114	A+115	A+116	A+117	A+118	A+119	A+120	A+121	A+122	A+123	A+124	A+125	A+126	A+127
8x	€	Sh↓	Sh↑	Ins	Ent (keyp)	F1	F2	F3	F4	F5	F6	F7	F8	F9	F10	F11
9x	F12	Home	End	Pg Up	Pg Dwn	↑	↓	←	→	Ar↓	Ar↑	Al↓	Al↑	Cl↓	Cl↑	Cr↓
Ax	Cr↑	A+0161	A+0162	A+0163	A+0164	A+0165	A+0166	A+0167	A+0168	A+0169	A+0170	A+0171	A+0172	A+0173	A+0174	A+0175
Bx	A+0176	A+0177	A+0178	A+0179	A+0180	A+0181	A+0182	A+0183	A+0184	A+0185	A+0186	A+0187	A+0188	A+0189	A+0190	A+0191
Cx	A+0192	A+0193	A+0194	A+0195	A+0196	A+0197	A+0198	A+0199	A+0200	A+0201	A+0202	A+0203	A+0204	A+0205	A+0206	A+0207
Dx	A+0208	A+0209	A+0210	A+0211	A+0212	A+0213	A+0214	A+0215	A+0216	A+0217	A+0218	A+0219	A+0220	A+0221	A+0222	A+0223
Ex	A+0224	A+0225	A+0226	A+0227	A+0228	A+0229	A+0230	A+0231	A+0232	A+0233	A+0234	A+0235	A+0236	A+0237	A+0238	A+0239
Fx	A+0240	A+0241	A+0242	A+0243	A+0244	A+0245	A+0246	A+0247	A+0248	A+0249	A+0250	A+0251	A+0252	A+0253	A+0254	A+0255

Interface Type PC AT PS/2 Alt Mode or USB-Keyboard Alt Mode (continued)

Table 27. Scancode Set When Control Character is 02

	x0	x1	x2	x3	x4	x5	x6	x7	x8	x9	xA	xB	xC	xD	xE	xF
0x	Ar↓	Ar↑	Al↓	Al↑	Cl↓	Cl↑	Cr↓	Cr↑	BS	Tab	→	S+ Tab	Enter Keypd	Enter	Ins	Pg Up
1x	Pg Dwn	Home	←	↓	↑	F6	F1	F2	F3	F4	F5	ESC	F7	F8	F9	F10
2x	A+032	A+033	A+034	A+035	A+036	A+037	A+038	A+039	A+040	A+041	A+042	A+043	A+044	A+045	A+046	A+047
3x	A+048	A+049	A+050	A+051	A+052	A+053	A+054	A+055	A+056	A+057	A+058	A+059	A+060	A+061	A+062	A+063
4x	A+064	A+065	A+066	A+067	A+068	A+069	A+070	A+071	A+072	A+073	A+074	A+075	A+076	A+077	A+078	A+079
5x	A+080	A+081	A+082	A+083	A+084	A+085	A+086	A+087	A+088	A+089	A+090	A+091	A+092	A+093	A+094	A+095
6x	A+096	A+097	A+098	A+099	A+100	A+101	A+102	A+103	A+104	A+105	A+106	A+107	A+108	A+109	A+110	A+111
7x	A+112	A+113	A+114	A+115	A+116	A+117	A+118	A+119	A+120	A+121	A+122	A+123	A+124	A+125	A+126	A+127
8x	A+0128	A+0129	A+0130	A+0131	A+0132	A+0133	A+0134	A+0135	A+0136	A+0137	A+0138	A+0139	A+0140	A+0141	A+0142	A+0143
9x	A+0144	A+0145	A+0146	A+0147	A+0148	A+0149	A+0150	A+0151	A+0152	A+0153	A+0154	A+0155	A+0156	A+0157	A+0158	A+0159
Ax	A+0160	A+0161	A+0162	A+0163	A+0164	A+0165	A+0166	A+0167	A+0168	A+0169	A+0170	A+0171	A+0172	A+0173	A+0174	A+0175
Bx	A+0176	A+0177	A+0178	A+0179	A+0180	A+0181	A+0182	A+0183	A+0184	A+0185	A+0186	A+0187	A+0188	A+0189	A+0190	A+0191
Cx	A+0192	A+0193	A+0194	A+0195	A+0196	A+0197	A+0198	A+0199	A+0200	A+0201	A+0202	A+0203	A+0204	A+0205	A+0206	A+0207
Dx	A+0208	A+0209	A+0210	A+0211	A+0212	A+0213	A+0214	A+0215	A+0216	A+0217	A+0218	A+0219	A+0220	A+0221	A+0222	A+0223
Ex	A+0224	A+0225	A+0226	A+0227	A+0228	A+0229	A+0230	A+0231	A+0232	A+0233	A+0234	A+0235	A+0236	A+0237	A+0238	A+0239
Fx	A+0240	A+0241	A+0242	A+0243	A+0244	A+0245	A+0246	A+0247	A+0248	A+0249	A+0250	A+0251	A+0252	A+0253	A+0254	A+0255

Microsoft Windows Codepage 1252

Windows-1252 is a character encoding of the Latin alphabet, used by default in the legacy components of Microsoft Windows in English and some other Western languages.

	00	01	02	03	04	05	06	07	08	09	0A	0B	0C	0D	0E	0F
00	NUL 0000	STX 0001	SOT 0002	ETX 0003	EOT 0004	ENQ 0005	ACK 0006	BEL 0007	BS 0008	HT 0009	LF 000A	VT 000B	FF 000C	CR 000D	SD 000E	SI 000F
10	DLE 0010	DC1 0011	DC2 0012	DC3 0013	DC4 0014	NAK 0015	SYN 0016	ETB 0017	CAN 0018	EM 0019	SUB 001A	ESC 001B	FS 001C	GS 001D	RS 001E	US 001F
20	SP 0020	! 0021	" 0022	# 0023	\$ 0024	% 0025	& 0026	' 0027	(0028) 0029	* 002A	+ 002B	, 002C	- 002D	. 002E	/ 002F
30	0 0030	1 0031	2 0032	3 0033	4 0034	5 0035	6 0036	7 0037	8 0038	9 0039	: 003A	; 003B	< 003C	= 003D	> 003E	? 003F
40	@ 0040	A 0041	B 0042	C 0043	D 0044	E 0045	F 0046	G 0047	H 0048	I 0049	J 004A	K 004B	L 004C	M 004D	N 004E	O 004F
50	P 0050	Q 0051	R 0052	S 0053	T 0054	U 0055	V 0056	W 0057	X 0058	Y 0059	Z 005A	[005B	\ 005C] 005D	^ 005E	_ 005F
60	` 0060	a 0061	b 0062	c 0063	d 0064	e 0065	f 0066	g 0067	h 0068	i 0069	j 006A	k 006B	l 006C	m 006D	n 006E	o 006F
70	p 0070	q 0071	r 0072	s 0073	t 0074	u 0075	v 0076	w 0077	x 0078	y 0079	z 007A	{ 007B	 007C	} 007D	~ 007E	DEL 007F
80	€ 20AC	• 20A2	ƒ 20A3	„ 20A4	… 20A5	† 20A6	‡ 20A7	ˆ 20A8	‰ 20A9	Š 20AA	< 20AB	€ 20AC	• 20AD	Ž 20AE	• 20AF	• 20B0
90	• 20B1	ˆ 20B2	˜ 20B3	˘ 20B4	• 20B5	– 20B6	— 20B7	ˆ 20B8	• 20B9	Š 20BA	› 20BB	œ 20BC	• 20BD	Ž 20BE	Ÿ 20BF	• 20C0
A0	NEST 00A0	ı 00A1	ı̇ 00A2	£ 00A3	¤ 00A4	¥ 00A5	ı̇ 00A6	ı̇ 00A7	ı̇ 00A8	ı̇ 00A9	ı̇ 00AA	ı̇ 00AB	ı̇ 00AC	ı̇ 00AD	ı̇ 00AE	ı̇ 00AF
B0	• 00B0	ı̇ 00B1	ı̇ 00B2	ı̇ 00B3	ı̇ 00B4	ı̇ 00B5	ı̇ 00B6	ı̇ 00B7	ı̇ 00B8	ı̇ 00B9	ı̇ 00BA	ı̇ 00BB	ı̇ 00BC	ı̇ 00BD	ı̇ 00BE	ı̇ 00BF
C0	À 00C0	Á 00C1	Â 00C2	Ã 00C3	Ä 00C4	Å 00C5	Æ 00C6	Ç 00C7	È 00C8	É 00C9	Ê 00CA	Ë 00CB	Ì 00CC	Í 00CD	Î 00CE	Ï 00CF
D0	Ð 00D0	Ñ 00D1	Ò 00D2	Ó 00D3	Ô 00D4	Õ 00D5	Ö 00D6	× 00D7	Ø 00D8	Ù 00D9	Ú 00DA	Û 00DB	Ü 00DC	Ý 00DD	Þ 00DE	ß 00DF
E0	à 00E0	á 00E1	â 00E2	ã 00E3	ä 00E4	å 00E5	æ 00E6	ç 00E7	è 00E8	é 00E9	ê 00EA	ë 00EB	ì 00EC	í 00ED	î 00EE	ï 00EF
F0	ø 00F0	ñ 00F1	ò 00F2	ó 00F3	ô 00F4	õ 00F5	ö 00F6	÷ 00F7	ø 00F8	ù 00F9	ú 00FA	û 00FB	ü 00FC	ý 00FD	þ 00FE	ÿ 00FF

ASCII Chart

ASCII Char.	Hex No.	ASCII Char.	Hex No.	ASCII Char.	Hex No.	ASCII Char.	Hex No.
NUL	00	SP	20	@	40	'	60
SOH	01	!	21	A	41	a	61
STX	02	"	22	B	42	b	62
ETX	03	#	23	C	43	c	63
EOT	04	\$	24	D	44	d	64
ENQ	05	%	25	E	45	e	65
ACK	06	&	26	F	46	f	66
BEL	07	'	27	G	47	g	67
BS	08	(28	H	48	h	68
HT	09)	29	I	49	i	69
LF	0A	*	2A	J	4A	j	6A
VT	0B	+	2B	K	4B	k	6B
FF	0C	,	2C	L	4C	l	6C
CR	0D	-	2D	M	4D	m	6D
SO	0E	.	2E	N	4E	n	6E
SI	0F	/	2F	O	4F	o	6F
DLE	10	0	30	P	50	p	70
DC1	11	1	31	Q	51	q	71
DC2	12	2	32	R	52	r	72
DC3	13	3	33	S	53	s	73
DC4	14	4	34	T	54	t	74
NAK	15	5	35	U	55	u	75
SYN	16	6	36	V	56	v	76
ETB	17	7	37	W	57	w	77
CAN	18	8	38	X	58	x	78
EM	19	9	39	Y	59	y	79
SUB	1A	:	3A	Z	5A	z	7A
ESC	1B	;	3B	[5B	{	7B
FS	1C	<	3C	\	5C		7C
GS	1D	=	3D]	5D	}	7D
RS	1E	>	3E	^	5E	~	7E
US	1F	?	3F	_	5F	DEL	7F



www.datalogic.com

©2017 Datalogic S.p.A. and/or its affiliates. All rights reserved.
Datalogic and the Datalogic logo are registered trademarks of Datalogic S.p.A. in many countries, including the U.S.A. and the E.U.

Datalogic S.r.l.

Via San Vitalino 13 | Calderara di Reno (BO) | 40012 | Italy
Telephone: +39 051 3147011 | Fax: +39 051 3147205

August 28, 2018