

MAGELLAN™ 3510HSi

QUICK REFERENCE GUIDE

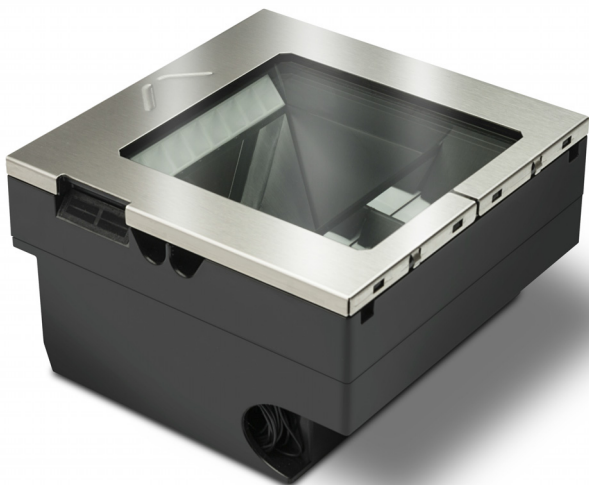

Omni-Directional Imaging Scanner

 **DATALOGIC**

Datalogic S.r.l.

Via S. Vitalino, 13
40012 Calderara di Reno — Italy
Tel. +39 051 3147011
Fax +39 051 3147205

©2020 Datalogic S.p.A. and/or its affiliates

All rights reserved. Without limiting the rights under copyright, no part of this documentation may be reproduced, stored in or introduced into a retrieval system, or transmitted in any form or by any means, or for any purpose, without the express written permission of Datalogic S.p.A. and/or its affiliates.

Owners of Datalogic products are hereby granted a non-exclusive, revocable license to reproduce and transmit this documentation for the purchaser's own internal business purposes. Purchaser shall not remove or alter any proprietary notices, including copyright notices, contained in this documentation and shall ensure that all notices appear on any reproductions of the documentation.

Electronic versions of this document may be downloaded from the Datalogic website (www.datalogic.com). If you visit our website and would like to make comments or suggestions about this or other Datalogic publications, please let us know via the "Contact" page.

Disclaimer

Datalogic has taken reasonable measures to provide information in this manual that is complete and accurate, however, Datalogic shall not be liable for technical or editorial errors or omissions contained herein, nor for incidental or consequential damages resulting from the use of this material. Datalogic reserves the right to change any specification at any time without prior notice.

Trademarks

Datalogic and the Datalogic logo are registered trademarks of Datalogic S.p.A. in many countries, including the U.S.A. and the E.U.

Magellan is a trademark of Datalogic S.p.A. or of Datalogic and/or its affiliates, registered in many countries, including the U.S. and the E.U.

Patents

See www.patents.datalogic.com for patent list.

This manual refers to software version DR9401453.

ORIGINAL VERSION

See the Regulatory Addendum included with your product for additional regulatory, safety and legal information.

TABLE OF CONTENTS

Features	1
Installation	2
How to Scan	5
Scanner Button	5
LED and Beeper Indicators	7
Beeper Indicators.....	8
Troubleshooting	9
Error Codes	10
Programming	10
Interface Selection	11
Cell Phone Mode	12
Cell Mode Percent	13
Cleaning	14
Manufacturer Approved Cleaning Materials.....	15
Warranty	16
Going Green	17
Bar Code Mask	18

NOTES

MAGELLAN™ 3510HSI

Use this guide to quickly complete installation of the Magellan 3510HSI series of bar code readers, and begin using your scanner. For more details and programming information, reference the Product Reference Guide (PRG), which is available for viewing and download from the Datalogic website listed on the back cover of this manual.

FEATURES

Figure 1. Scanner Features - Top View

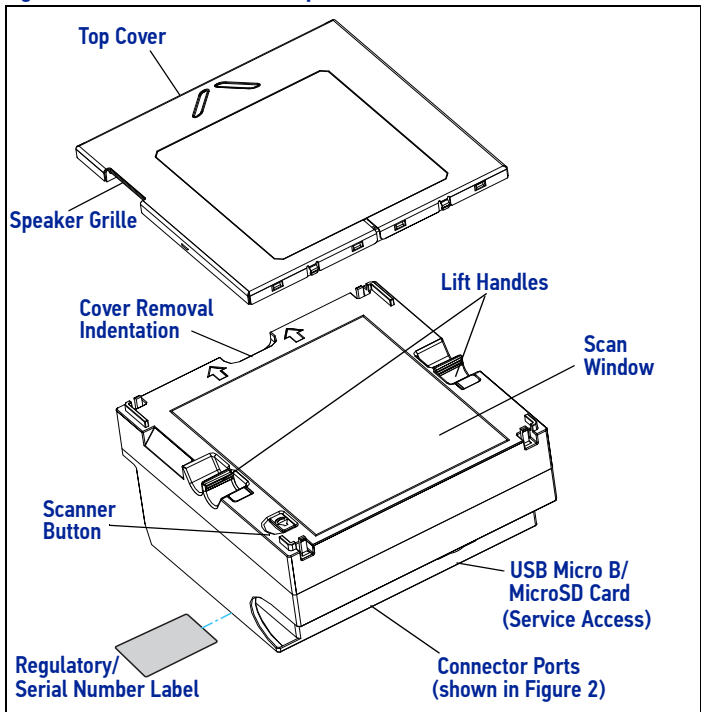
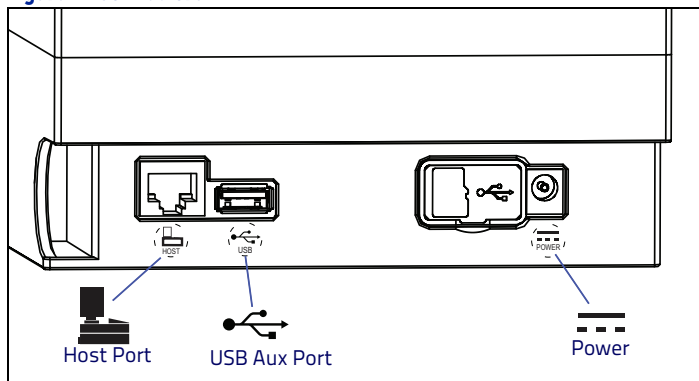

Figure 2. Connectors

INSTALLATION

Connect the scanner to the host (terminal) using the interface (I/F) cable as shown in the following figures. A cable from an older existing installation can be re-used only for RS-232 interfaces. If external power is used/needed, plug the AC Adapter into the AC wall outlet, then connect it to the unit as shown in [Figure 4](#). If the scanner is powered only by the standard USB cable as shown in [Figure 5 on page 4](#), an auxiliary scanner will not be supported.

After the scanner has fully powered up and indicates that it is ready for operation, scan some known-good bar code samples to verify correct operation. The scanner should beep and/or flash its good read LED₁ and send the bar code data to the host or terminal. If not, use the Troubleshooting section of this guide to identify any problems.

1. Beeper and LED behavior may have previously been configured as "disabled" by another user.

Figure 3. USB + Power Cable Power Off the Terminal**Figure 4. Powered by AC Adapter**

Figure 5. USB Cable Type A Power Off the Terminal



NOTE: This cable (or similar) will not support a USB peripheral. The system must be powered by 12V in order for a peripheral to be attached to the AUX USB PORT.

HOW TO SCAN

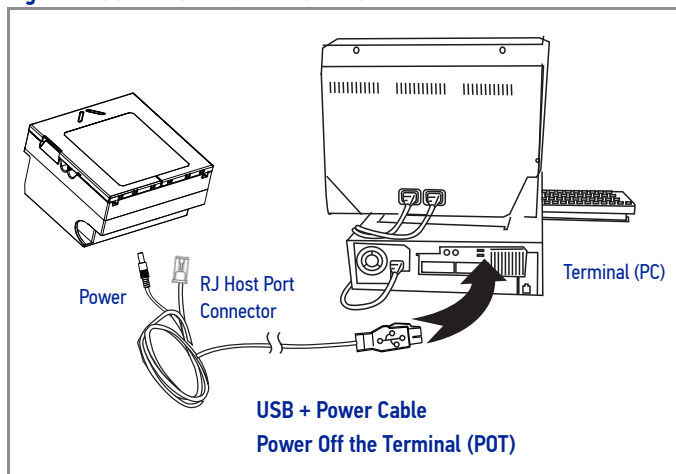
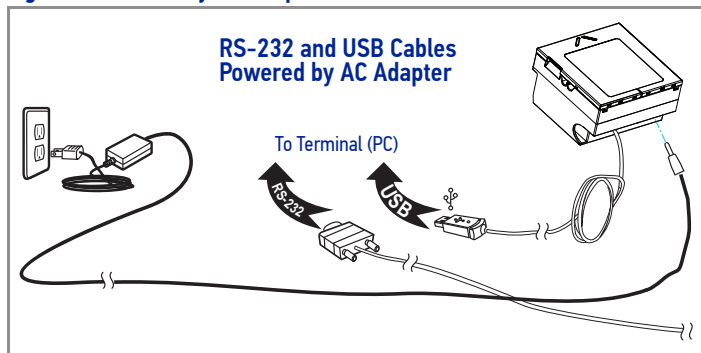
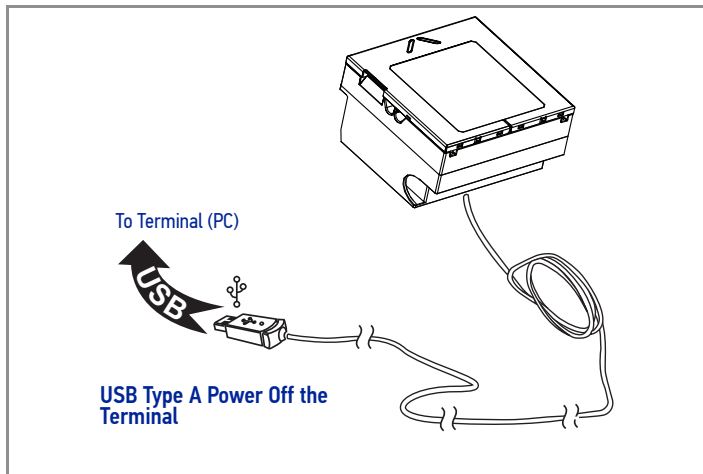
The scanner is mounted flush with the counter to allow items to be slid or pushed over its top in the direction of the arrow as shown in [Figure 6](#). Face the bar code toward the scanner or direction of scan to optimize the scan rate.

Figure 6. Scanning Items

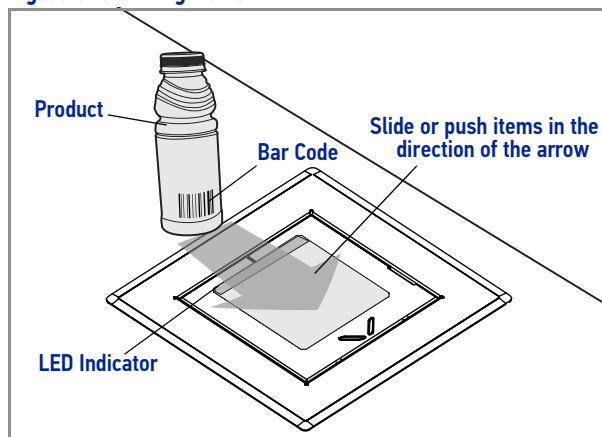

Scanner Button

The Scanner Button performs multiple functions, depending on how long it is pressed:



NOTE: Volume changes made using the Scanner Button are lost when the scanner is powered down and are reset to the configured setting. If you wish to permanently change the volume, use the programming labels in the Product Reference Guide.

PRESS DURATION	FUNCTION	COMMENT
Momentary (when scanner is asleep)	Wakes scanner from Sleep Mode	Alternatively, the scanner can be awakened by: - Moving an object through the scan zone. - Scanning with an attached auxiliary scanner.
Momentary (when scanner is awake)	Increments volume	Press the button momentarily to increase speaker volume. When the loudest volume is reached, a repeated press of the button cycles volume back to the lowest setting, then volume increases on subsequent press(es). Five volume levels are available.
Hold, then release when the beeper sounds	Increments tone	Press the button for approximately 2 seconds, then release. Each time this is done, the beeper will sound at one of three tones. Stop when the desired tone (high, medium or low) is sounded.
4 Seconds	Scanner Diagnostics Mode ^a	This mode allows system support personnel to troubleshoot problems with the scanner and is used to determine if it can read bar codes. Press the button for 10 seconds or cycle power to exit Scanner Diagnostics Mode and reset the scanner.
10 Seconds	Resets Scanner ^b	Only system support personnel should perform a reset.

a. By standard default, this function is normally disabled to prevent accidental activation by users.

b. Users should not perform scanner resets except under the direction of trained systems support personnel.

LED AND BEEPER INDICATORS

The scanner's beeper sounds and its green LED illuminates to indicate various functions or errors on the scanner. The tables that follow list these indications. An exception is that the scanner's functions are programmable, and may or may not be turned on. For example, some indications (such as the power-up beep) can be disabled using programming bar code labels.

LED Indicators

LED INDICATION	INDICATION	COMMENT
Power-up indication	Constant bright green	Indicates the scanner is running power-up tests and is not yet ready for operation.
Good Read Indication	Bright green flash	Indicates a bar code has been read and decoded.
Scanner Ready	Constant dim green	The scanner is ready for operation.
Sleep Mode	Green LED flashes every 2 seconds (10mS on, 1990mS off).	The scanner is in Sleep Mode. To wake the scanner up, move an object in front of its window or press the Scanner Button. This indication is optionally configurable, and may have been programmed to behave differently.
Host Disable	Constant green flash at 1 Hz (100mS on, 900mS off)	The scanner is disabled due to receiving a disable command from the POS terminal.
Diagnostics	Varies (see "Error Codes" on page 10 for more information)	The LED can provide diagnostic feedback if the scanner discovers a problem during SelfTest.
Prog. Mode	Constant green flash at 1 Hz (500 ms on, 500 ms off).	The scanner is in Programming Mode.

Beeper Indicators

BEEPER INDICATION	INDICATION	COMMENT
Power On Beep	Single beep	The Power-On LED indication is a configurable feature which can be enabled or disabled. When enabled, this beep indicates the scanner has finished all its power-up tests and is now ready for operation.
Good Read Indication	Single beep	The good read beep indication is configurable. Options include: Enable/disable, frequency, duration and volume. See the Product Reference Guide (PRG) for more information.
Diagnostics	Varies (see "Error Codes" on page 10 for more information)	The Beeper can provide diagnostic feedback if the scanner discovers a problem during SelfTest.
Programming Mode Indications	Varies depending upon the feature(s) being configured.	The Beeper will sound as programming bar code labels are scanned, indicating progress during scanner configuration.

TROUBLESHOOTING

PROBLEM	SOLUTION
Scanner does not power on	Exchange the power supply with a known good power supply and retest operation.
No communication with the host	Consult your technical support personnel or refer to your host system manual to verify the proper interface type, cable and connection port(s) for the scanner. Verify the interface cable is securely attached to the host and the scanner.
The scanner will not read bar codes at all, or reads poorly	Make sure the window is clean. Check that the bar codes are of sufficient quality to be recognized by the scanner. Wrinkled, smudged, or torn labels can cause the scanner to not read at all. Scan known-good labels of an active symbology ^a to check the scanner's read operation.
If the scanner still does not function properly, consult the Product Reference Guide (PRG) or contact your local supplier or Datalogic Customer Support Services.	
<p>a. Reading of the various bar code symbologies can be independently enabled or disabled in the scanner.</p>	

ERROR CODES

If an error is detected, the scanner will sound a long low tone (for three seconds) and flash its LED, indicating a failure. When this occurs, press the Scanner button to hear the error code. If it is configured to do so, the scanner will sound a series of beeps corresponding to the error code and/or flash its LED simultaneous to the beeps. The table below describes what these codes mean and what action should be taken for each.

NUMBER OF LED FLASHES/BEEPS	ERROR	CORRECTIVE ACTION
1	Configuration	Contact Helpdesk for assistance
2	Host Interface	
6	Main PCB	
10	Button Error	
11	USB Device	
13	CPLD ID	

PROGRAMMING

Upon completing the physical connection between the scanner and its host, proceed directly to the Programming Bar Codes table below to locate the interface type the scanner is connected to (for example: RS-232, USB, etc.).

Use the Bar Code Mask at the back of this manual to isolate the bar code you want to scan. Scan a START/END bar code once to enter Programming Mode. After scanning the programming label, scan the START/END barcode a second time to accept your changes, exit Programming Mode and return the scanner to normal operation.







Select other options and customize your scanner with programming barcodes available in the PRG, or use the Datalogic Scanalyzer utility available on the Datalogic website.



NOTE: In the following sections, text shown with a green star indicates a factory default value.

★ This is an example of a default value.





Interface Selection

 START / END
PROGRAMMING BAR CODES
 RS-232 Standard
 RS-232 Wincor-Nixdorf
 USB-OEM
 USB Keyboard
 USB COM Interface



NOTE: Refer to the **Product Reference Guide (PRG)** or **Datalogic Scanalyzer utility** for additional options.

Cell Phone Mode

Enables/disables mobile phone barcode reading.    



	 Cell Phone Mode = Enable (Toggle)
 ★ Cell Phone Mode = Enable (Always On)	
	 Cell Phone Mode = Enable (Timer Expiration)





Cell Mode Percent

Specifies the rate of frames dedicated to reading cell phones. Cell phone mode must be enabled for this to be active.



NOTE: Settings above 10% will slow down read performance on printed barcodes.



	 ★ Cell Mode Percent = 5% (Very Low)
 Cell Mode Percent = 10% (Low)	
	 Cell Mode Percent = 20% (Medium)
 Cell Mode Percent = 30% (Med High)	
	 Cell Mode Percent = 50% (High)

CLEANING

Exterior surfaces and scan windows exposed to spills, smudges or debris accumulation require periodic cleaning to assure best performance during scanning. Use a clean, lint-free cloth or paper towel dampened with a nonabrasive, mild, water-based cleaner to wipe away stains, smudges, fingerprints, spills, etc. from the scan window and exterior surfaces.

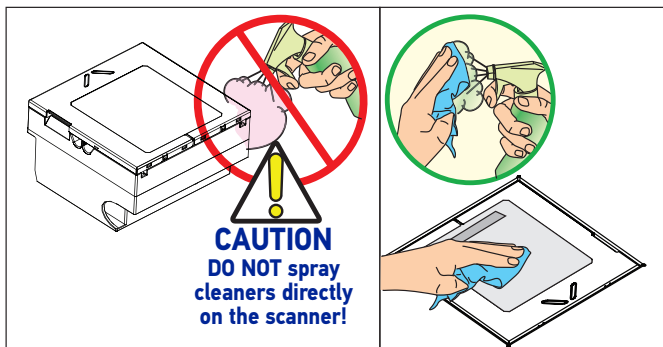

CAUTION: DO NOT use abrasive cleaning agents or abrasive pads to clean this product. Harsh chemicals, disinfectants, and cleansers can cause damage which will adversely affect scanning performance.

See the next page for a list of [Manufacturer Approved Cleaning Materials](#).

Manufacturer Approved Cleaning Materials

Datalogic recommends the use of the following cleaners on its products.



APPROVED CLEANERS

- Hydrogen Peroxide (not to exceed a 3% solution)
- Chlorine bleach (not to exceed a 0.25% solution)
- Mild detergent and water
- Isopropyl Alcohol (not to exceed a 70% solution)



CAUTION: Use of above cleaners *in combination with each other* is not recommended and may constitute a health hazard. Follow all specified safety precautions when using any cleaning solution.

Under no circumstances should abrasive cleansers, abrasive pads, caustic solutions or other harsh chemicals, including those listed below, be used on any part of the scanner as they can cause damage which will adversely affect scanning performance. Use of such materials, either alone or in combination with other cleaning agents, will void the manufacturer's warranty.



!!DO NOT USE!!

- | | |
|---------------------|---|
| • Ammonia solutions | • Trichloroethylene |
| • Acetone | • Toluene |
| • Benzene | • Carboric acid |
| • Ethanolamine | • Aromatic or chlorinated hydrocarbons |
| • Ethers | • Aqueous or alcoholic alkaline solutions |
| • Ketones | |

WARRANTY

Datalogic warrants that the Products shall be free from defects in materials and workmanship under normal and proper use during the Warranty Period. Products are sold on the basis of specifications applicable at the time of manufacture and Datalogic has no obligation to modify or update Products once sold. The Warranty Period shall be **three years** from the date of shipment by Datalogic, unless otherwise agreed in an applicable writing by Datalogic.

Datalogic will not be liable under the warranty if the Product has been exposed or subjected to any: (1) maintenance, repair, installation, handling, packaging, transportation, storage, operation or use that is improper or otherwise not in compliance with Datalogic's instruction; (2) Product alteration, modification or repair by anyone other than Datalogic or those specifically authorized by Datalogic; (3) accident, contamination, foreign object damage, abuse, neglect or negligence after shipment to Buyer; (4) damage caused by failure of a Datalogic-supplied product not under warranty or by any hardware or software not supplied by Datalogic; (5) any device on which the warranty void seal has been altered, tampered with, or is missing; (6) any defect or damage caused by natural or man-made disaster such as but not limited to fire, water damage, floods, other natural disasters, vandalism or abusive events that would cause internal and external component damage or destruction of the whole unit, consumable items; (7) use of counterfeit or replacement parts that are neither manufactured nor approved by Datalogic for use in Datalogic-manufactured Products; (8) any damage or malfunctioning caused by non-restoring action as for example firmware or software upgrades, software or hardware reconfigurations etc.; (9) loss of data; (10) any consumable or equivalent (e.g. cables, power supply, batteries, etc.); or (11) any device on which the serial number is missing or not recognizable.

THE DATALOGIC WARRANTIES ARE EXCLUSIVE AND IN LIEU OF ALL OTHER WARRANTIES, WHETHER WRITTEN, EXPRESS, IMPLIED, STATUTORY OR OTHERWISE, INCLUDING, BUT NOT LIMITED TO, THE IMPLIED WARRANTIES OF MERCHANTABILITY AND FITNESS FOR PARTICULAR PURPOSE. DATALOGIC SHALL NOT BE LIABLE FOR ANY DAMAGES SUSTAINED BY BUYER ARISING FROM DELAYS IN THE REPLACEMENT OR REPAIR OF PRODUCTS UNDER THE ABOVE. THE REMEDY SET FORTH IN THE WARRANTY STATEMENT IS THE BUYER'S SOLE AND EXCLUSIVE REMEDY FOR WARRANTY CLAIMS. NO EXTENSION OF THIS WARRANTY WILL BE BINDING UPON DATALOGIC UNLESS SET FORTH IN WRITING AND SIGNED BY DATALOGIC'S AUTHORIZED REPRESENTATIVE. DATALOGIC'S LIABILITY FOR DAMAGES ON ACCOUNT OF A CLAIMED DEFECT IN ANY PRODUCT DELIVERED BY DATALOGIC SHALL IN NO EVENT EXCEED THE PURCHASE PRICE OF THE PRODUCT ON WHICH THE CLAIM IS BASED. DATALOGIC SHALL NOT BE LIABLE FOR DAMAGES RELATING TO ANY INSTRUMENT, EQUIPMENT, OR APPARATUS WITH WHICH THE PRODUCT SOLD UNDER THIS AGREEMENT IS USED. Further details on warranty coverage, rights and conditions are addressed under and regulated by the Terms and Conditions of Sales of Datalogic available at https://www.datalogic.com/terms_conditions_sales.

GOING GREEN

Thank you for using the bar code mask on the opposite side of this page. This manual has been formatted to minimize the quantity of pages needed to provide the programming bar codes available for this product.



BAR CODE MASK

Cut a hole in this page and remove it from the manual as indicated to create a sleeve through which bar codes can be individually viewed and scanned. It is important that only one bar code at a time be presented to the scanner.

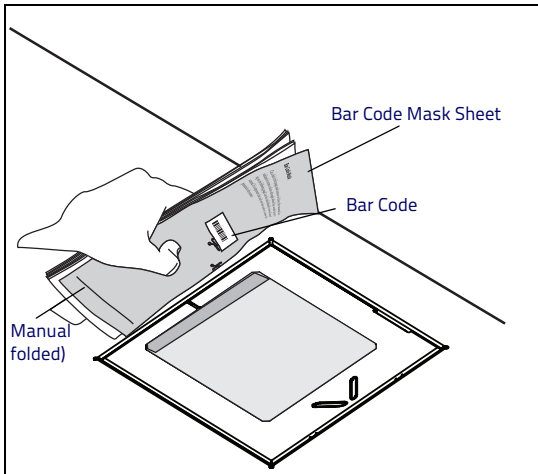
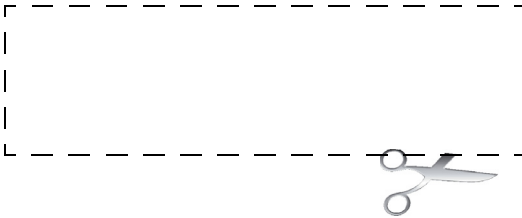

©2020 Datalogic S.p.A. and/or its affiliates • All rights reserved •
Without limiting the rights under copyright, no part of this documentation may be reproduced, stored in or introduced into a retrieval system, or transmitted in any form or by any means, or for any purpose, without the express written permission of Datalogic S.p.A. and/or its affiliates • Datalogic and the Datalogic logo are registered trademarks of Datalogic S.p.A. in many countries, including the U.S. and the E.U.

 **DATALOGIC**

www.datalogic.com

Datalogic S.r.l.

Via S. Vitalino, 13 | 40012 Lippo di Calderara di Reno |
Bologna - Italy Tel. +39 051 3147011 |
Fax +39 051 3147205



820117901

(Rev. A)

December 2020

